

Präzisionswerkzeuge „Made in Germany“

Precision Tools



	M MF MJ EG M
	G Rc, R Pg
	UNC UNF UN UNJF
	NPT NPTF
	M MF M keg. M taper
	G BSW BSF DIN 477 R, BA, Pg
	UNC UNF UNEF UN, UNS
	NPSM NPT NPTF Tr, Rd
	M MF
	G BSW BSF R, Pg MF-EL
	UNC, UNF UNEF UN, UNS UNJC UNJF
	NPT NPTF Tr EG



M
MF
MJ
EG M

G
Rc, R
Pg

UNC
UNF
UN
UNJF

NPT
NPTF



M
MF
M keg.
M taper

G
BSW
BSF
DIN 477
R, BA, Pg

UNC
UNF
UNEF
UN, UNS

NPSM
NPT
NPTF
Tr, Rd



M
MF

G
BSW
BSF
R, Pg
MF-EL

UNC, UNF
UNEF
UN, UNS
UNJC
UNJF

NPT
NPTF
Tr
EG



Geschäftsleitung Management
Thomas Rapp, Melanie Boss, Heinz Boss

Partnerschaft „Made in Germany“

Partnership

Willkommen bei einem der weltweit führenden Anbieter von Präzisionswerkzeugen für die Herstellung und Prüfung von Gewinden.

Welcome to one of the world's leading providers of precision tools for manufacturing and checking threads.



Der Weg zu JBO

The way to JBO

Johs. Boss GmbH & CO. KG
Präzisionswerkzeugfabrik
Precision Tool Manufacturer

Johannes-Boss-Straße 9
72461 Albstadt (Onstmettingen)
Germany

Tel. +49 7432 9087 0
Fax +49 7432 9087 60

contact@johs-boss.de
www.johs-boss.de

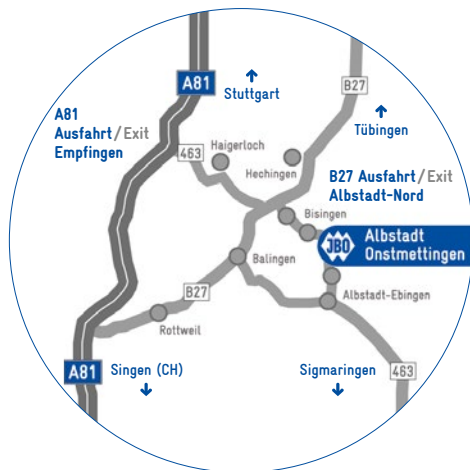

Burg / Castle Hohenzollern



M
MF
MJ
EG M

G
Rc, R
Pg

UNC
UNF
UN
UNJF

NPT
NPTF

M
MF
M keg.
M taper

G
BSW
BSF
DIN 477
R, BA, Pg

UNC
UNF
UNEF
UN, UNS

NPSM
NPT
NPTF
Tr, Rd

M
MF

G
BSW
BSF
R, Pg
MF-EL

UNC, UNF
UNEF
UN, UNS
UNJC
UNJF

NPT
NPTF
Tr
EG

Kontakt

Contact



Anfragen / Bestellungen / Fragen zur Lieferung
Inquiries / Orders / Matters concerning delivery



+49 7432 9087 750
contact@johs-boss.de



order@johs-boss.de
www.johs-boss.de



Technische Beratung
Technical advice

	Gewindefräser Thread Milling Cutters	+49 7432 9087 754
	Glockengewindefräser, Kombinationswerkzeuge Shell Type Thread Milling Cutters, Combination Tools	+49 7432 9087 754
	PKD-, CVD-D-, PcBN-Werkzeuge PCD, CVD-D, PcBN Tools	+49 7432 9087 754
	Schneideisen High Performance Thread Cutting Dies	+49 7432 9087 752
	Gewinderolleisen Thread Rolling Dies	+49 7432 9087 752
	Gewindelehren Thread Gauges	+49 7432 9087 752



Lieferung „Heute“
Shipment "today"

Aufträge, die bis 15:00 Uhr in unserem Hause eingehen und mit dem Vermerk „Heute“ versehen sind, kommen noch am selben Tag zur Auslieferung.

Urgent orders received by 3 pm and endorsed "today" will be dispatched on the same day.

JBO von 7:30 – 17:00 Uhr

JBO customer service from 7:30 am to 5:00 pm

Unsere Mitarbeiter stehen Ihnen von 7:30-17:00 Uhr für alle Fragen, die im Zusammenhang mit unseren Produkten stehen, gerne zur Verfügung.

Our staff is at your disposal from 7:30 am to 5:00 pm for all matters concerning our products.



Service vor Ort
On-site service

Gerne erarbeiten wir mit Ihnen vor Ort die optimale Lösung für die Aufgabenstellung im Zerspanungs- und Gewindeprüfbereich. Dabei werden Sie unterstützt von unserem erfahrenen Team.

Our experienced team will gladly work with you on location to achieve optimum solutions to your machining and testing jobs.



M
MF
MJ
EG M

G
Rc, R
Pg

UNC
UNF
UN
UNJF

NPT
NPTF



M
MF
M keg.
M taper

G
BSW
BSF
DIN 477
R, BA, Pg

UNC
UNF
UNEF
UN, UNS

NPSM
NPT
NPTF
Tr, Rd



M
MF

G
BSW
BSF
R, Pg
MF-EL

UNC, UNF
UNEF
UN, UNS
UNJC
UNJF

NPT
NPTF
Tr
EG

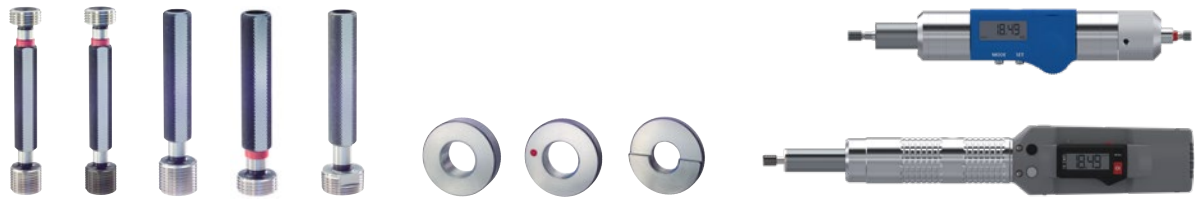

Inhalt

Content

JBO – Allgemeine Informationen

JBO – General Information

Gewindefräser

Thread Milling Cutters

Glockengewindefräser Kombinationswerkzeuge

Shell Type Thread Milling Cutters
Combination Tools

PKD-, CVD-D-, PcBN-Werkzeuge

PCD, CVD-D, PcBN Tools

Hochleistungs-Schneideisen

High Performance Thread Cutting Dies

Hochleistungs-Gewinderolleisen

High Performance Thread Rolling Dies

Präzisions-Gewindelehren

Precision Thread Gauges



8



37



117



127



145



207



219

M
MF
MJ
EG M

G
Rc, R
Pg

UNC
UNF
UN
UNJF

NPT
NPTF



M
MF
M keg.
M taper

G
BSW
BSF
DIN 477
R, BA, Pg

UNC
UNF
UNEF
UN, UNS

NPSM
NPT
NPTF
Tr, Rd



M
MF

G
BSW
BSF
R, Pg
MF-EL

UNC, UNF
UNEF
UN, UNS
UNJC
UNJF

NPT
NPTF
Tr
EG

Kann es ein schöneres Symbol geben für ein Unternehmen, das seit 6 Generationen in die Zukunft denkt?

Can there be a better symbol for a company that has been working in a future-oriented manner for six generations?



M
MF
MJ
EG M

6
Rc, R
Pg

UNC
UNF
UN
UNJF

NPT
NPTF



M
MF
M keg.
M taper

6
BSW
BSF
DIN 477
R, BA, Pg

UNC
UNF
UNEF
UN, UNS

NPSM
NPT
NPTF
Tr, Rd



M
MF

6
BSW
BSF
R, Pg
MF-EL

UNC, UNF
UNEF
UN, UNS
UNJC
UNJF

NPT
NPTF
Tr
EG

Gewinde

Filetage

Schroefdraad

螺纹

Σπείρωμα

Thread

Filettatura

ねじ

резьба

Rosca



M
MF
MJ
EG M

G
Rc, R
Pg

UNC
UNF
UN
UNJF

NPT
NPTF



M
MF
M keg.
M taper

G
BSW
BSF
DIN 477
R, BA, Pg

UNC
UNF
UNEF
UN, UNS

NPSM
NPT
NPTF
Tr, Rd



M
MF

G
BSW
BSF
R, Pg
MF-EL

UNC, UNF
UNEF
UN, UNS
UNJC
UNJF

NPT
NPTF
Tr
EG

175 Jahre JBO: „Eine Erfolgsgeschichte mit Präzision und Gewinden“

175 years JBO: “A success story with precision and threads”

Werkstatt in der Wilhelmstraße, etwa um 1889
workshop in the Wilhelm street, approx. 1889



Katalog 1895
catalogue 1895



Belegschaft 1904
staff 1904



1849

Johannes Boss gründete eine feinmechanische Werkstatt für den Bau von Präzisionswaagen. In den folgenden Jahrzehnten kamen Pillenmaschinen und andere Präzisionsinstrumente für Apotheker hinzu. Das Unternehmen wuchs, baute eine weitere Fabrik in Onstmettingen und wandelte sich gegen Ende des Jahrhunderts von einem Handwerksbetrieb zu einem industriell geführten Unternehmen.

Johannes Boss founded a precision engineering workshop for the construction of precision scales. In the following decades, pill machines and other precision instruments for pharmacists were added. The company grew, built another factory in Onstmettingen and towards the end of the century transformed from a craft business to an industrially managed company.

1914

Der Ausbruch des 1. Weltkriegs führte zu einschneidenden Veränderungen. Präzisionswaagen bestanden überwiegend aus Messing. Dieser Werkstoff wurde unerwartet für die Munitionsherstellung benötigt. Gleichzeitig entstand ein großer Bedarf an Werkzeugen – die gesamte Produktion musste umgestellt werden. Die Entscheidung fiel auf das Gewindeschneiden.

Seit dieser Zeit ist das “Gewinde” das zentrale Kompetenzfeld des Unternehmens.

The outbreak of World War I led to drastic changes. Precision scales were mainly made of brass. This material was unexpectedly needed for the production of ammunition. At the same time, there was a great need for tools – the entire production had to be changed. The decision was made in favour of thread cutting.

Since then, “threading” has been the company’s central area of expertise.

1949

Richard Boss hat ein engmaschiges Vertreternetz über alle vier Besatzungszonen aufgebaut. Es werden wieder 55 Mitarbeiter beschäftigt.

Das 100-jährige Jubiläum konnte gefeiert werden.

Richard Boss has built up a close-knit network of representatives across all four occupation zones. The company employs 55 people again.

The 100th anniversary could be celebrated.

1958

Rationalisierung war gefragt. Es wurde eine eigene Automationsabteilung eingerichtet.

1962 trat Herr Heinz Boss in das Unternehmen ein.

Rationalisation was in demand. A separate automation department was set up.

In 1962, Mr. Heinz Boss joined the company.

Neubau 1904
new building 1904



Katalog etwa um 1952
catalogue approx. 1952



Firmengründer Johannes Boss (Bild), Heinz Boss (5. Generation),
Melanie Boss (6. Generation) und dazwischen die 7. Generation Svenja.

Company founder Johannes Boss (picture), Heinz Boss (5th generation),
Melanie Boss (6th generation) and between the 7th generation Svenja.



1985

Ausdehnung des Kompetenzfeldes „Gewinde“. Ein umfassendes Gewindelehren-Sortiment wurde in das Produktions- und Verkaufsprogramm aufgenommen. Linear- und Dreheinheiten, die seit den 60er Jahren, in der Automationsabteilung, für die eigene Rationalisierung hergestellt worden sind, wurden ein fester Bestandteil des Verkaufsprogrammes.

A comprehensive range of thread gauges was added to the production and sales programme. Linear and rotary units, which had been produced in the automation department since the 1960s for the company's own rationalisation, became an integral part of the sales programme.

1997

Wiederaufnahme der Herstellung von Gewindefräsern für den Vertrieb. 1999 trat Frau Melanie Boss in 6. Generation in das Unternehmen ein. Im Jahr 2000 wurden Bohrgewindefräser und Kombinationswerkzeuge ins Produktionsprogramm aufgenommen. Es folgten eine sukzessive Erweiterung der Produktionskapazität, der Neubau von weiteren Produktionshallen am Standort (2002 und 2008), sowie 2010 die wesentliche Vergrößerung von Lager/Versand und der Bürofläche zum „Open-Space-Büro“.

Resumption of the production of thread milling cutters for distribution. 1999 Mrs. Melanie Boss joined the company as the 6th generation. In 2000, thread milling cutters and combination tools were added to the production programme. This was followed by a successive expansion of the production capacity, the construction of additional production halls at the site (2002 and 2008), as well as the substantial enlargement of the warehouse/dispatch department and the office space into an "open-space office" in 2010.

2013

Produktion von PKD, CVD-D- und PcBN-Werkzeugen.
Die Internationalisierung wurde vorangetrieben. Heute ist JBO weltweit in mehr als 60 Märkten vertreten.

Production of PCD, CVD-D and PcBN tools.
Internationalisation was driven forward. Today, JBO is represented in more than 60 markets worldwide.

2019

Die 3. Produktions- und Technikhalle mit Klimatisierung eröffnet neue Möglichkeiten für die Expansion von JBO über die aktuelle Mitarbeiterzahl von 160 hinaus.

The 3rd production and technical hall with air conditioning opens up new possibilities for the expansion of JBO beyond the current number of 160 employees.

2024

175 Jahre

Johs. Boss GmbH & CO. KG
Präzisionswerkzeugfabrik
Precision Tool Manufacturer



M
MF
MJ
EG M

G
Rc, R
Pg

UNC
UNF
UN
UNJF

NPT
NPTF



M
MF
M keg.
M taper

G
BSW
BSF
DIN 477
R, BA, Pg

UNC
UNF
UNEf
UN, UNS

NPSM
NPT
NPTF
Tr, Rd



M
MF

G
BSW
BSF
R, Pg
MF-EL

UNC, UNF
UNEf
UN, UNS
UNJC
UNJF

NPT
NPTF
Tr
EG

Wer Schnelligkeit, Flexibilität und Präzision verbinden will, braucht Wissen, Ideen – und die richtige Unternehmensgröße.

If you want to connect speed with flexibility and precision, you need experience and ideas – and a company of the appropriate size.



- M
MF
MJ
EG M
- 6
Rc, R
Pg
- UNC
UNF
UN
UNJF
- NPT
NPTF
- 6
BSW
BSF
DIN 477
R, BA, Pg
- UNC
UNF
UNEF
UN, UNS
- NPSM
NPT
NPTF
Tr, Rd
- M
MF
- 6
BSW
BSF
R, Pg
MF-EL
- UNC, UNF
UNEF
UN, UNS
UNJC
UNJF
- NPT
NPTF
Tr
EG

JBO – Partnerschaft „Made in Germany“.

Wie wird man zu einem der weltweit führenden Anbieter von Präzisionswerkzeugen für die Herstellung und Prüfung von Gewinden? Für JBO ist die Antwort klar: Man wird es, indem man die Wünsche und Herausforderungen seiner Kunden zu seinen eigenen macht. Indem man sich frühzeitig an den Markterfordernissen orientiert und Innovation als Chance begreift. Indem man Qualität systematisch plant und mit Leidenschaft neue Lösungen entwickelt.

Bei JBO handeln wir mittlerweile in sechster Generation nach diesen Leitsätzen. Unser Erfolg beruht zudem auf dem Bekenntnis zu unserem Standort – sämtliche JBO Werkzeuge werden in Albstadt hergestellt – sowie auf unseren motivierten Mitarbeitern, von denen wir viel fordern, die wir aber auch in ihrer Entwicklung fördern.

Entdecken Sie wer wir sind, wie wir denken und was wir dafür tun, um auch in Zukunft der Schrittmacher in einem anspruchsvollen Markt zu bleiben.

JBO – Partnership “Made in Germany”.

How to become one of the world’s leading suppliers of precision tools for the manufacture and testing of threads? In the case of JBO the answer is quite obvious: by adopting the wishes and challenges of its customers as its own. By orienting oneself to market needs at an early stage and recognizing innovation as an opportunity. By systematically planning quality and developing new solutions with passion.

In the meantime, we are operating at JBO according to these principles in the sixth generation. Our success is also due to the commitment shown to our location – all JBO tools are manufactured in Albstadt – and to our motivated employees, of whom we demand a lot, but at the same time also try to encourage in their development.

Discover who we are, how we think and what we do in order to remain pacesetters – also in the future – in a demanding market.



JBO:
„klein“ genug, um schnell und flexibel reagieren zu können – groß genug für eine hochwertige und zuverlässige Fertigung.

JBO:
“small” enough to react quickly and flexibly – big enough for high-quality and reliable productions.



M
MF
MJ
EG M

G
Rc, R
Pg

UNC
UNF
UN
UNJF

NPT
NPTF



M
MF
M keg.
M taper

G
BSW
BSF
DIN 477
R, BA, Pg

UNC
UNF
UNEF
UN, UNS

NPSM
NPT
NPTF
Tr, Rd



M
MF

G
BSW
BSF
R, Pg
MF-EL

UNC, UNF
UNEF
UN, UNS
UNJC
UNJF

NPT
NPTF
Tr
EG

Präzision in der Fertigung

Precision manufacturing

1849 begannen wir in Albstadt mit der Fertigung unserer hochpräzisen Produkte, deren Spektrum im 1. Weltkrieg um Gewindegewindeisen und 1937 um Gewindefräser erweitert wurde. Seit 1985 fertigen wir auch Gewindelehren. Wir fertigen auf Maschinen, die wir in großem Umfang, beginnend 1958, im eigenen Hause entwickelt haben.

In 1849, we began manufacturing our high-precision products in Albstadt. During World War I, we added thread cutting dies to our range, and in 1937, thread milling cutters. Since 1985, we have also been manufacturing thread gauges. We produce on machines that we developed on a large scale in-house, starting in 1958.



Die kleinste Normtoleranz bei Gewindelehren ist 0,005 mm. Für unsere Fertigung bedeutet dies, dass wir anstreben mit einer eingeschränkten Toleranz von

0,003

 mm zu fertigen.

The smallest standard tolerance for thread gauges is 0.005 mm. For our production, this means that we aim to manufacture with a limited tolerance of 0.003 mm.



M
MF
MJ
EG M

G
Rc, R
Pg

UNC
UNF
UN
UNJF

NPT
NPTF

M
MF
M keg.
M taper

G
BSW
BSF
DIN 477
R, BA, Pg

UNC
UNF
UNEf
UN, UNS

NPSM
NPT
NPTF
Tr, Rd

M
MF

G
BSW
BSF
R, Pg
MF-EL

UNC, UNF
UNEf
UN, UNS
UNJC
UNJF

NPT
NPTF
Tr
EG

Präzision ab Lager

Precision ex stock



Mit unserem umfassenden Lager, das Ihnen die 22.000 gängigsten Gewindeabmessungen und -toleranzen an Gewindeschneisen und Gewindelehren bietet, sind wir Marktführer.

We are the market leader with our comprehensive stock, which offers you the 22,000 most common thread dimensions and tolerances of threading dies and thread gauges.

10.000

verschiedene Schneideisen auf Lager
different thread cutting dies in stock

2.000

verschiedene Bohr-/Gewindefräser auf Lager
different (drill) thread milling cutters in stock

10.000

verschiedene Gewindelehren auf Lager
different thread gauges in stock



M
MF
MJ
EG M

G
Rc, R
Pg

UNC
UNF
UN
UNJF

NPT
NPTF



M
MF
M keg.
M taper

G
BSW
BSF
DIN 477
R, BA, Pg

UNC
UNF
UNEf
UN, UNS

NPSM
NPT
NPTF
Tr, Rd



M
MF

G
BSW
BSF
R, Pg
MF-EL

UNC, UNF
UNEf
UN, UNS
UNJf
UNJF

NPT
NPTF
Tr
EG

JBO Automation

Linear- und Dreheinheiten als moderne Automatisierungskomponenten

Linear and rotary units as modern automation components

JBO blickt auf eine nahezu 40-jährige Erfahrung in der Entwicklung und Konstruktion von Linear- und Dreheinheiten zurück, welche sehr vielseitig einsetz- und kombinierbar sind. Sie sind für komplexe Automationsanlagen, wie auch einfache Handarbeitsplätze verwendbar. Die von uns entwickelten Automationskomponenten können in bereits bestehende Anlagen integriert werden um beispielsweise teilautomatisierte in vollautomatisierte Anlagen umzubauen.

JBO looks back on almost 40 years of experience in the development and construction of linear and rotary units, which can be used and combined in many different ways. They can be used for complex automation systems as well as simple manual workstations. The automation components developed by us can be integrated into already existing systems, for example to convert partially automated systems into fully automated systems.

Für die unterschiedlichen Anwendungsfälle stellen wir die passende Automatisierung bereit:
We provide the appropriate automation for the various applications:

Die Dreheinheiten der Baureihe NCT mit ihren unterschiedlichen Baugrößen zeichnen sich durch ihre Laufruhe und hohe Belastbarkeit aus. Sie sind verfügbar mit ein- und zweiseitiger Schnecken-Wellenlagerung zur Übertragung von besonders hohen Antriebs- bzw. Haltemomenten. Die Dreheinheiten sind für beliebige Winkelsteuerung und endlose Drehwinkel konzipiert.

The rotary units of the NCT series with their different sizes are characterised by their smooth running and high resilience. They are available with single- and double-sided screw shaft bearings for the transmission of particularly high drive or holding torques. The rotary units are designed for any angle control and endless angles of rotation.

Dreheinheiten

In unterschiedlichen Größen und Ausführungen

Rotary units

In different sizes and versions



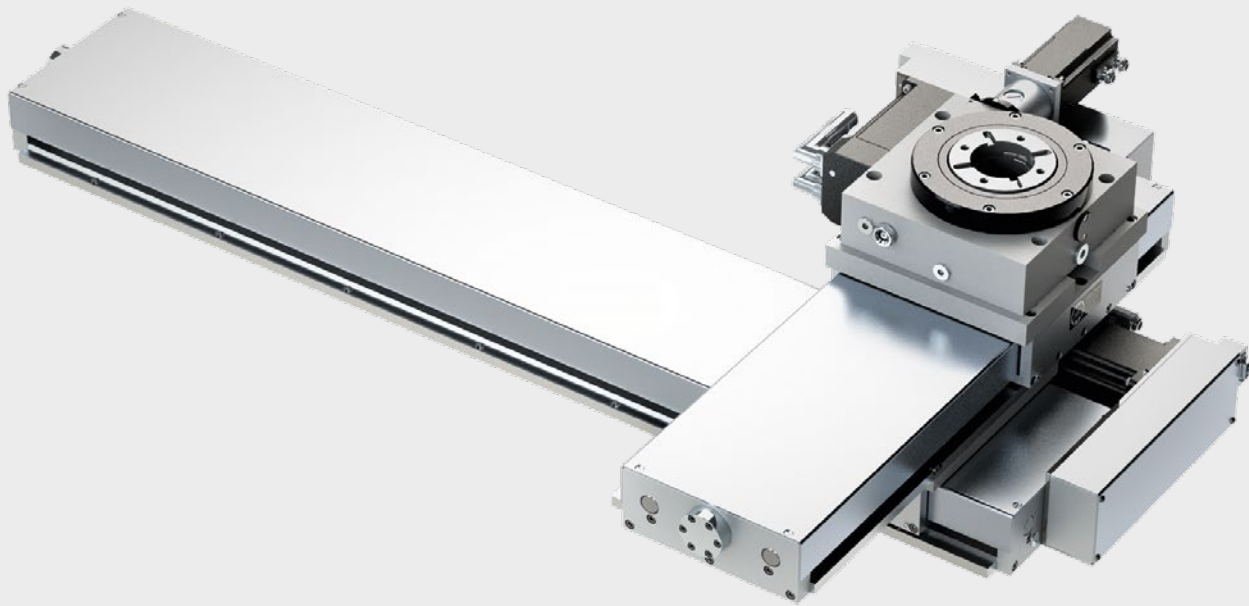

Auch für spezielle Anwendungsfälle entwickeln wir die optimalste Lösung für Sie.
 We also develop the most optimal solution for you for special applications.

JBO Lineareinheiten bieten ein großes Produktportfolio in flacher Bauweise mit Zahnriemen- oder Kugelgewinde-trieb. Lieferbar sind diese Einheiten bis zu einer Länge von 6 m wobei sie mit einem oder zwei Laufwagen aus-
 rüstbar sind. Durch eine Lebensdauer-Fettschmierung sind die Einheiten sehr wartungsarm. Die unterschiedlichen
 Achssysteme lassen sich beispielsweise zu einem Portal mit X-, Y- und Z-Achse kombinieren.

JBO linear units offer a large product portfolio in flat design with toothed belt or ball screw drive. These units are
 available up to a length of 6 m and can be equipped with one or two carriages. Due to a lifetime grease lubrication
 the units require very little maintenance. The different axis systems can be combined to form a portal with X-, Y-
 and Z-axes, for example.

Lineareinheiten

In verschiedenen Bau- und Abdeckungsgrößen
 Einfach kombinierbar zu Achssystemen



Linear units

In various construction and cover sizes
 Easy to combine into axis systems

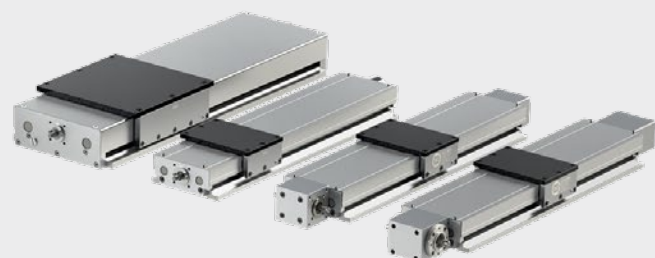

M
MF
MJ
EG M

G
Rc, R
Pg

UNC
UNF
UN
UNJF

NPT
NPTF



M
MF
M keg.
M taper

G
BSW
BSF
DIN 477
R, BA, Pg

UNC
UNF
UNEF
UN, UNS

NPSM
NPT
NPTF
Tr, Rd



M
MF

G
BSW
BSF
R, Pg
MF-EL

UNC, UNF
UNEF
UN, UNS
UNJC
UNJF

NPT
NPTF
Tr
EG

Wir machen die Prozesse für unsere Kunden immer effizienter, wirtschaftlicher, einfacher und angenehmer.

We make the processes for our customers more efficient, more economical, easier and more pleasant.

Nachschleif und -bestückungs Service

Regrinding and tipping service

Werkzeugaufbereitung
Tool reconditioning

Service
Service

Global presence
Globale Präsenz

Accredited calibration laboratory
Akkreditiertes Kalibrierlabor

Wir bieten für Sie:

- Software für Gewindeprogramme und eMultiCheck
- Online Lagerauskunft
- Datenbereitstellung BME-Cut
- Werkzeugpool
- Electronic Data Interchange

We offer for you:

- software for thread programmes and eMultiCheck
- online stock information
- data provision BME-Cut
- tool pool
- Electronic Data Interchange

Wir sind weltweit für Sie da!

- Begleiteter Erstwerkzeugeinsatz vor Ort
- Schulungen in Albstadt, vor Ort oder Online
- Anwendungstechnik vor Ort oder Online
- Vertretungen oder Handelspartner in Ihrer Nähe
- Messepräsenz

We are there for you worldwide!

- accompanied initial tooling on site
- training in Albstadt, on site or online
- application technology on site or online
- representatives or trade partners in your vicinity
- trade fair presence

Wir bieten für Sie in unserem DAkKS-akkreditierten Kalibrierlabor:

- DAkKS-Kalibrierscheine
- Werkskalibrierscheine
- Rekalibrierung gebrauchter Gewindelehren
- Gewindevermessung und -bestimmung

Zusätzlich sind wir Mitglied im DIN Ausschuss Gewinde

We offer for you in our DAkKS accredited calibration laboratory:

- DAkKS calibration certificates
- calibration certificates
- recalibration of used thread gauges
- thread measurement and determination

In addition, we are a member of the DIN Thread Committee



Was können wir für Sie tun?

What can we do for you?

Wir fertigen seit über 100 Jahren Werkzeuge zur Herstellung von Gewinden für Sie.
In unserem Maschinenbau entwickeln wir unsere eigenen Maschinen und Automatisierungen.

For over 100 years we have been manufacturing tools for the production of threads for you.
In our mechanical engineering department we develop our own machines and automations.



Wir produzieren für Sie in Albstadt:

- Gewindefräser
- Glockengewindefräser
- Kombinationswerkzeuge
- PKD-, CVD-D-, PoBN-Werkzeuge
- Hochleistungs-Schneideisen
- Hochleistungs-Gewinderolleisen
- Präzisions-Gewindelehren

We produce for you in Albstadt:

- thread milling cutters
- shell type thread milling cutters
- combination tools
- PCD, CVD-D, PoBN tools
- high performance thread cutting dies
- high performance thread rolling dies
- precision thread gauges

Wir entwickeln unsere Produkte ständig für Sie weiter und bieten Ihnen folgende Vorteile:

- Machbarkeitsuntersuchung und Schneidstoffempfehlung
- Schnittkraftberechnung und Schnittwertbestimmung
- Eigenes Versuchsfeld für Entwicklung und Kundenversuche
- Vielzahl an Geometrien und Beschichtungssystemen

We are constantly developing our products for you and offer you the following advantages:

- feasibility study and cutting material recommendation
- cutting force calculation and cutting value determination
- own test field for development and customer trials
- variety of geometries and coating systems

Wir halten für Sie in unserem Lager

- 10.000 verschiedene Schneideisen
- 10.000 verschiedene Gewindelehren
- 2.000 verschiedene Bohr-/Gewindefräser vor und liefern weltweit

We keep for you in our stock

- 10,000 different dies
- 10,000 different thread gauges
- 2,000 different drill-/thread milling cutters and deliver worldwide

M
MF
MJ
EG M

G
Rc, R
Pg

UNC
UNF
UN
UNJF

NPT
NPTF

M
MF
M keg.
M taper

G
BSW
BSF
DIN 477
R, BA, Pg

UNC
UNF
UNEF
UN, UNS

NPSM
NPT
NPTF
Tr, Rd

M
MF

G
BSW
BSF
R, Pg
MF-EL

UNC, UNF
UNEF
UN, UNS
UNJC
UNJF

NPT
NPTF
Tr
EG

Neues entsteht im intensiven Dialog

Die Entwicklung von Sonderwerkzeugen

New tools are created through intensive dialogue

Development of special tools

Projekttablauf Sonderwerkzeuge

Project flow for special tools

Am Anfang steht das Werkstück. Oder das Leistungs-Profil der vorgesehenen CNC-Maschine. Oder ein technisches Lastenheft...

In the beginning, there is the tool, or the capacity profile of the CNC machine to be realized, or maybe technical specifications...

Auf jeden Fall aber eine präzise Analyse der Aufgabenstellung, der internen und externen Einflussgrößen beim Kunden. Meist beginnt das Projekt mit einem intensiven Gespräch im Unternehmen vor Ort.

In any case, there is a precise analysis of the task and the internal and external parameters of the client. In many cases, however, there is a discussion in the company at the beginning of the project.

Dann wird JBO-intern geprüft, ob eine Neuentwicklung notwendig wird, oder ob eine bereits vorhandene Lösung auf die neue Aufgabe angepasst werden kann.

Then, JBO will perform an internal check to determine if a new development is required or if an already existing solution can be adapted to the new task.

Dabei können wir auf viele tausend Lösungen zurückgreifen. In unserem Lager – oder in unserem Erfahrungsschatz, der über viele Jahrzehnte gewachsen ist. Die entsprechenden Werkzeuge werden entwickelt, erprobt, mit dem Kunden diskutiert, optimiert und in den Produktionsprozess integriert. Auch hier stehen wir gerne mit an der Maschine, um mit dem Kunden die letzten Feinheiten zu justieren.

In doing so, we can rely on a lot of previous solutions, either from our inventory or from our long-term experience which has been growing extensively over the last decades. The respective tools will be developed, tested, discussed with the client, optimized and implemented into the production process. Also with regard to this task, we like to be involved to be able to adjust the fine settings together with the client.

Bei besonderen Lösungen entwickeln wir unsere besonderen Stärken – in der Technik und im konstruktiven Miteinander.

For special solutions, we develop our special strengths – in technology and in the constructive cooperation.



Alles aus einer Hand „Ihr Komplettservice“

Everything from a single source
“your full service”



Deutsche
Akkreditierungsstelle
D-K-21417-01-00

Bei JBO verschmelzen Produkt und Dienstleistung. Von der Entwicklung, über die Herstellung bis hin zum Kalibrierschein aus unserem DAkkS akkreditierten Kalibrierlaboratorium (gemäß DIN EN ISO/IEC 17025), erhalten Sie alles bei JBO.

At JBO, product and service merge. From development and production to the calibration certificate from our DAkkS accredited calibration laboratory (according to DIN EN ISO/IEC 17025), you get everything at JBO.



Gegenstand Object		Gewinde-Grenztrommeln Threaded limit gauges	
Hersteller Manufacturer	Johs. Boss GmbH & Co. KG	Dieser Kalibrierschein dokumentiert die metrologische Rückführbarkeit auf nationale Normale zur Darstellung der Einheiten in Übereinstimmung mit dem Internationalen Einheitensystem (SI). The DAkkS is a signatory to the multilateral agreement of the European co-operation for Accreditation (EA) and of the International Laboratory Accreditation Cooperation (ILAC) for the mutual recognition of calibration certificates. The user is obliged to have the object recalibrated at appropriate intervals.	
Typ Type	M 8x1-GH	This calibration certificate documents the metrological traceability to national standards, which realize the units of measurement according to the international system of units (SI). The DAkkS is signatory to the multilateral agreements of the European cooperation for Accreditation (EA) and of the International Laboratory Accreditation Cooperation (ILAC) for the mutual recognition of calibration certificates. The user is obliged to have the object recalibrated at appropriate intervals.	
Identnummer Serial number	184912345	This calibration certificate documents the metrological traceability to national standards, which realize the units of measurement according to the international system of units (SI). The DAkkS is signatory to the multilateral agreements of the European cooperation for Accreditation (EA) and of the International Laboratory Accreditation Cooperation (ILAC) for the mutual recognition of calibration certificates. The user is obliged to have the object recalibrated at appropriate intervals.	
Kunde Customer	Johs. Boss GmbH & Co. KG Johannes-Boss-Straße 9 72461 Albstadt Germany	This calibration certificate documents the metrological traceability to national standards, which realize the units of measurement according to the international system of units (SI). The DAkkS is signatory to the multilateral agreements of the European cooperation for Accreditation (EA) and of the International Laboratory Accreditation Cooperation (ILAC) for the mutual recognition of calibration certificates. The user is obliged to have the object recalibrated at appropriate intervals.	
Auftragsnummer Order No.	20206502	This calibration certificate documents the metrological traceability to national standards, which realize the units of measurement according to the international system of units (SI). The DAkkS is signatory to the multilateral agreements of the European cooperation for Accreditation (EA) and of the International Laboratory Accreditation Cooperation (ILAC) for the mutual recognition of calibration certificates. The user is obliged to have the object recalibrated at appropriate intervals.	
Anzahl der Seiten des Kalibrierscheins Number of pages of the certificate	3	This calibration certificate documents the metrological traceability to national standards, which realize the units of measurement according to the international system of units (SI). The DAkkS is signatory to the multilateral agreements of the European cooperation for Accreditation (EA) and of the International Laboratory Accreditation Cooperation (ILAC) for the mutual recognition of calibration certificates. The user is obliged to have the object recalibrated at appropriate intervals.	
Datum der Kalibrierung Date of calibration	10.12.2021	This calibration certificate documents the metrological traceability to national standards, which realize the units of measurement according to the international system of units (SI). The DAkkS is signatory to the multilateral agreements of the European cooperation for Accreditation (EA) and of the International Laboratory Accreditation Cooperation (ILAC) for the mutual recognition of calibration certificates. The user is obliged to have the object recalibrated at appropriate intervals.	
Dieser Kalibrierschein darf nur vollständig und unverändert weitervertrieben werden. Auszüge oder Änderungen bedürfen der Genehmigung des ausstellenden Kalibrierlaboratoriums. Kalibrierscheine sind bei Nennung des für die Frage der Verantwortlichen in Klarschrift auch ohne Unterschrift gültig. This calibration certificate may not be reproduced other than in full except with the permission of the issuing laboratory. Calibration certificates with the full name of the appointed responsible person are valid without signature.			
Datum der Ausstellung Date of issue	Freigabe des Kalibrierscheins durch Approval of the certificate of calibration by	Bearbeiter Person in charge	
10.12.2021	Hödrich (Leitung Kalibrierlaboratorium) Schumacher (Leitung Kalibrierlaboratorium)	Giganti	

Ihre Vorteile bei JBO: Your advantages at JBO:

- Kurze Lieferzeit (3 Tage ab Lager/für Katalogware)
short delivery time (3 days from stock/for catalogue goods)
- Ressourcensparnis/Reduzierung der Prozesskosten beim Kunden (kein weiterer Waren aus- und Wareneingang für einen DAkkS-Kalibrierschein)
saving of resources/reduction of process costs at the customer's (no additional goods out and goods in for a DAkkS calibration certificate)
- Kein n.i.O. Kalibrierschein bei Neuware
no "not in order" calibration certificate for new goods
- Hohe Aussagekraft der Messwerte durch kleinste Messunsicherheit
high informative value of the measured values due to smallest measurement uncertainty

Generelle Vorteile einer DAkkS Kalibrierung: General advantages of a DAkkS calibration:

- Höchste Genauigkeit und größte Sicherheit durch validierte Prozesse
highest accuracy and greatest safety through validated processes
- International anerkannt und gültig (ILAC)
internationally recognised and valid (ILAC)
- Rückführung auf nationale und internationale Normale
traceability to national and international norms

Gewindeherstellung und -prüfung einer Crashbox mit Abschlepphaken

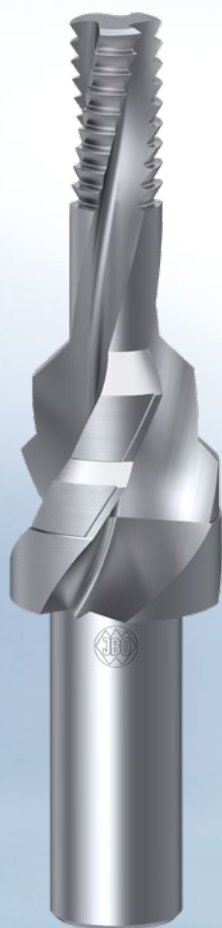

Werkstück: Crashbox mit Abschlepphaken-Halterung

Werkzeug:	Vollhartmetall Gewindefräser
Werkstoff:	Aluminium stranggepresst
Drehzahl:	$n = 6.000 \text{ min}^{-1}$
Vorschub _{senken} :	$V_f \text{ senken} = 1.200 \text{ mm/min}$
Vorschub _{gewindefräsen} :	$V_f \text{ gewindefräsen} = 1.000 \text{ mm/min}$
Bearbeitungszeit:	$t = 9 \text{ s}$
Standzeit:	>50.000 Stück

Workpiece: crashbox with towing hook fixture

Tool:	Solid carbide thread milling cutter
Material:	Aluminium extruded
Cutting speed:	$n = 6,000 \text{ rpm}$
Feed rate _{chamfering} :	$V_f \text{ chamfering} = 1,200 \text{ mm/min}$
Feed rate _{thread milling} :	$V_f \text{ thread milling} = 1,000 \text{ mm/min}$
Machining time:	$t = 9 \text{ s}$
Tool life:	>50,000 pieces



Werkstück: Abschlepphaken

Werkzeug:	Präzisions-Schneideisen HSSE Schäl., geläppt, nitriert
Werkstoff:	41Cr4
Drehzahl:	$n = 110 \text{ min}^{-1}$
Bearbeitungszeit:	$t = 10 \text{ s}$
Standzeit:	1.200 Stück

Workpiece: towing hook

Tool:	Precision thread cutting die HSSE spiral entry, lapped, nitrided
Material:	41Cr4
Cutting speed:	$n = 110 \text{ rpm}$
Machining time:	$t = 10 \text{ s}$
Tool life:	1,200 pieces

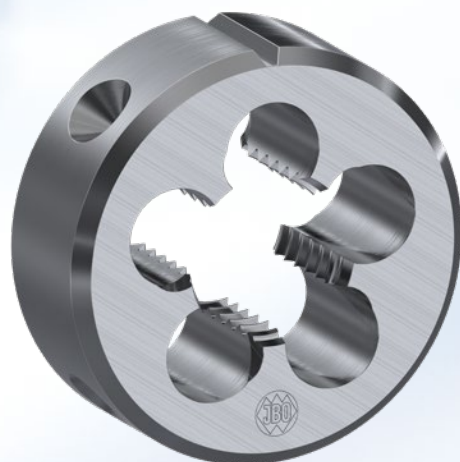

Thread production and checking of a crashbox with hook fixture

Werkstück: Crashbox mit Abschlepphaken-Halterung

Prüfmittel: Gewinde-Gutlehrdorn S 22 x 3,1 links ausgelegt nach Taylorschem Grundsatz
Gewinde-Ausschusslehrdorn S 22 x 3,1 links

Vorteile: schnelle und einfache Prüfung des Gewindes, Funktion und Austauschbarkeit werden sichergestellt

Workpiece: crashbox with towing hook fixture

Testing equipment: GO thread plug gauge S 22 x 3.1 left hand designed according to Taylor's principle
NOT GO thread plug gauge S 22 x 3.1 left hand

Advantages: quick and easy testing of the thread, function and interchangeability are ensured



Werkstück: Abschlepphaken

Prüfmittel: Gewinde-Gutlehrherring S 22 x 3,1 links ausgelegt nach Taylorschem Grundsatz
Gewinde-Ausschusslehrherring S 22 x 3,1 links

Vorteile: schnelle und einfache Prüfung des Gewindes, Funktion und Austauschbarkeit werden sichergestellt

Workpiece: towing hook

Testing equipment: GO thread ring gauge S 22 x 3.1 left hand designed according to Taylor's principle
NOT GO thread ring gauge S 22 x 3.1 left hand

Advantages: quick and easy testing of the thread, function and interchangeability are ensured

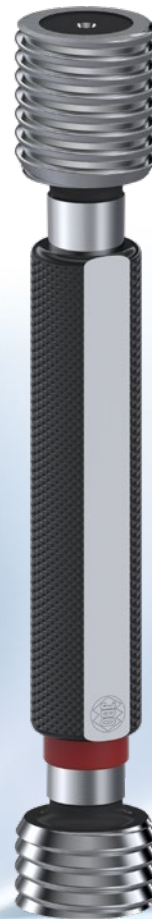
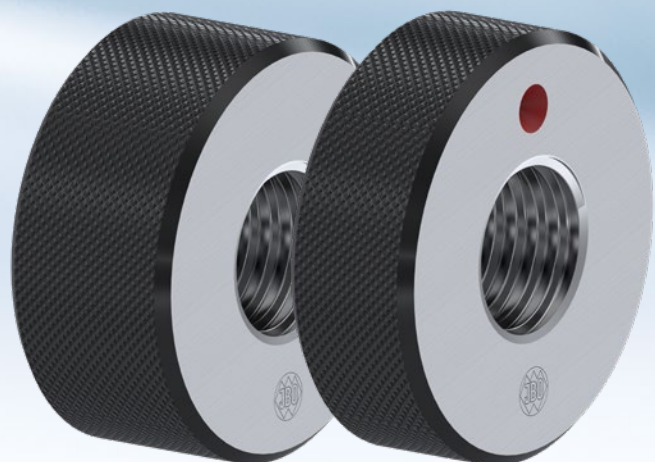

M
MF
MJ
EG M

G
Rc, R
Pg

UNC
UNF
UN
UNJF

NPT
NPTF



M
MF
M keg.
M taper

G
BSW
BSF
DIN 477
R, BA, Pg

UNC
UNF
UNEF
UN, UNS

NPSM
NPT
NPTF
Tr, Rd



M
MF

G
BSW
BSF
R, Pg
MF-EL

UNC, UNF
UNEF
UN, UNS
UNJC
UNJF

NPT
NPTF
Tr
EG

Bearbeitungsbeispiel

Production example

Werkstück: Hauptbremszylinder

Werkzeug:	PKD Bohrgewindefräser M 12 x 1 IK
Werkstoff:	Aluminium Druckguss
Schnittgeschw. bohren:	V_c bohren = 150 m/min
Vorschub bohren:	f_{bohren} = 0,16 mm/Umdr.
Schnittgeschw. fräsen:	V_c fräsen = 310 m/min
Vorschub fräsen:	f_z fräsen = 0,11 mm/Zahn
Bearbeitungszeit:	t = 4 s

Workpiece: master brake cylinder

Tool:	PCD Drill thread milling cutter M 12 x 1 IC
Material:	Aluminum die casting
Cutting speed drilling:	V_c drilling = 150 m/min
Feed rate drilling:	f_{drilling} = 0,16 mm/Umdr.
Cutting speed milling:	V_c milling = 310 m/min
Feed rate milling:	f_z milling = 0,11 mm/teeth
Machining time:	t = 4 s

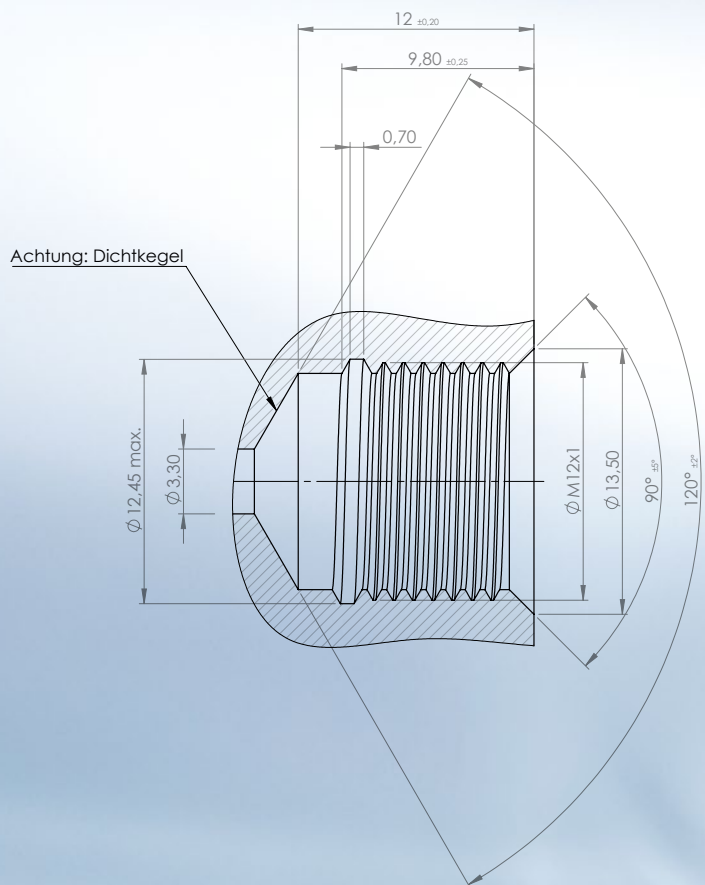

Details

1. Schneidstoff PKD
2. Geradgenutet – Dichtfläche im Bohrungsgrund
3. Innere Kühlschmiermittelzufuhr

Details

1. Cutting material PCD
2. Straight flute – sealing surface in the bottom of the hole
3. Internal coolant

Vorteile

- Reduzierung der Haupt- und Nebenzeiten auf 4 s
- Vereinen von 4 Bearbeitungsoperationen
- Verbesserung der Oberflächenqualität des Gewindes
- Erhöhung der Standzeit
- Reduzierung der Werkzeugkosten durch mehrmaliges Neubestücken der PKD-Schneiden

Advantages

- Reduction of the main and auxiliary times to 4 s
- Combining of 4 machining operations
- Improvement of the surface quality of the thread
- Increase of tool life
- Reduction of tool costs due to repeated renewing of the PCD cutting edges

Bearbeitungsbeispiel

Production example

Werkstück: Ölfiltergehäuse

Werkzeug: PKD Gewindefräser D25x31xS3 IK
Werkstoff: Aluminium Druckguss
Schnittgeschw. fräsen: V_c fräsen = 750 m/min
Vorschub fräsen: f_z fräsen = 0,1 mm/Zahn
Bearbeitungszeit: t = 8 s

Workpiece: oil filter housing

Tool: PCD thread milling cutter D25x31xS3 IC
Material: Aluminum die casting
Cutting speed milling: V_c milling = 750 m/min
Feed rate milling: f_z milling = 0,1 mm/teeth
Machining time: t = 8 s

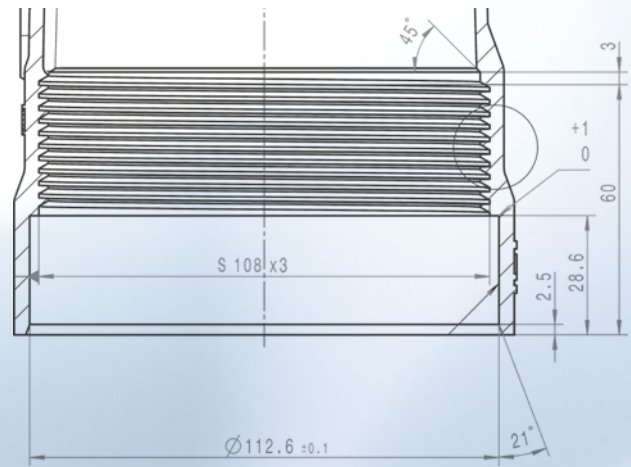

Details

1. Schneidstoff PKD
2. PKD-Schneide mit Achswinkel
3. Seitliche Kühlschmiermittelzufuhr

Details

1. Cutting material PCD
2. PCD cutting edge with axis angle
3. Lateral coolant supply

Vorteile

- Reduzierung der Haupt- und Nebenzeiten auf 8 s
- Entgratschneide zum Entfernen des letzten unvollständigen Gewindeganges
- Vereinen von 3 Bearbeitungsoperationen
- Verbesserung der Oberflächenqualität des Gewindes
- Erhöhung der Standzeit
- Reduzierung der Werkzeugkosten durch mehrmaliges Neubestücken der PKD-Schneiden

Advantages

- Reduction of the main and auxiliary times to 8 s
- Deburring teeth for removing the last incomplete thread part
- Combining of 4 machining operations
- Improvement of the surface quality of the thread
- Increase of tool life
- Reduction of tool costs by repeated renewing of the PCD cutting edges



M
MF
MJ
EG M

G
Rc, R
Pg

UNC
UNF
UN
UNJF

NPT
NPTF



M
MF
M keg.
M taper

G
BSW
BSF
DIN 477
R, BA, Pg

UNC
UNF
UNEF
UN, UNS

NPSM
NPT
NPTF
Tr, Rd



M
MF

G
BSW
BSF
R, Pg
MF-EL

UNC, UNF
UNEF
UN, UNS
UNJC
UNJF

NPT
NPTF
Tr
EG

Bearbeitungsbeispiel

Production example

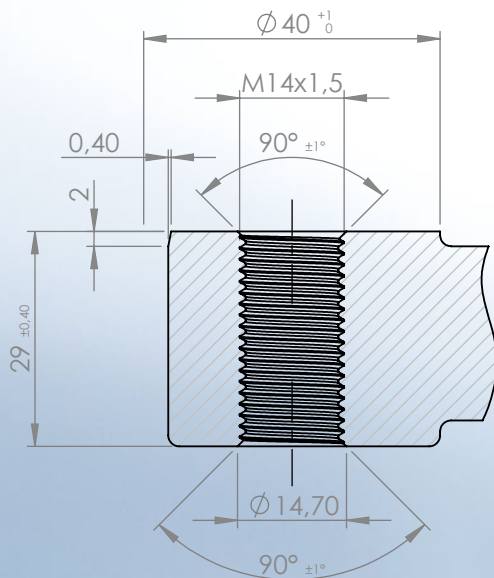

Werkstück: Motorabdeckung

Werkzeug:	Kombinationswerkzeug	
Werkstoff:	AlSi9Cu3	
Drehzahl:	n	= 5.100 min ⁻¹
Vorschub _{bohren} :	f _{bohren}	= 0,35 mm
Vorschub _{planspiegeln} :	f _{planspiegeln}	= 0,1 mm
Vorschub _{gewindefräsen} :	f _{z gewindefräsen}	= 0,12 mm
Bearbeitungszeit:	t	= 6 s
Standzeit:	>40.000 Stück	

Workpiece: engine cover

Tool:	Combination tool	
Material:	AlSi9Cu3	
Cutting speed:	n	= 5,100 rpm
Feed rate _{drilling} :	f _{drilling}	= 0,35 mm
Feed rate _{spot facing} :	f _{spot facing}	= 0,1 mm
Feed rate _{thread milling} :	f _{z thread milling}	= 0,12 mm
Machining time:	t	= 6 s
Tool life:	>40,000 pieces	



Modularer Werkzeugaufbau

1. Werkzeugträger HSK-A 63
2. 1x VHM Bohrgewindefräser
BGFZ M14x1,5 IK z=3
3. 3x Wendeschneidplatte TCGX090204

Modular tool construction

1. Tool holder HSK-A 63
2. 1x solid carbide drill thread milling cutter
BGFZ M14x1.5 IC z=3
3. 3x insert TCGX090204

Vorteile

- Reduzierung der Haupt- und Nebenzeiten auf 6 s
- Vereinen von 3 Bearbeitungsoperationen
- Erhöhung der Flexibilität durch modularen Aufbau

Advantages

- Reduction of the main and auxiliary times to 6 s
- Combining 3 machining operations
- Increased flexibility through modular construction

Bearbeitungsbeispiel

Production example

Werkstück: Bremszylinder

Werkzeug: PKD-Aufbohrwerkzeug
Werkstoff: AlSi9Cu3
Drehzahl: $n = 2.400 \text{ min}^{-1}$
Vorschub_{bohren}: $V_f \text{ bohren} = 480 \text{ mm/min}$
Bearbeitungszeit: $t = 8 \text{ s}$
Standzeit: $> 80.000 \text{ Stück}$

Workpiece: break cylinder

Tool: PCD core drill
Material: AlSi9Cu3
Cutting speed: $n = 2.400 \text{ rpm}$
Feed rate_{drilling}: $V_f \text{ drilling} = 480 \text{ mm/min}$
Machining time: $t = 8 \text{ s}$
Tool life: $> 80.000 \text{ pieces}$

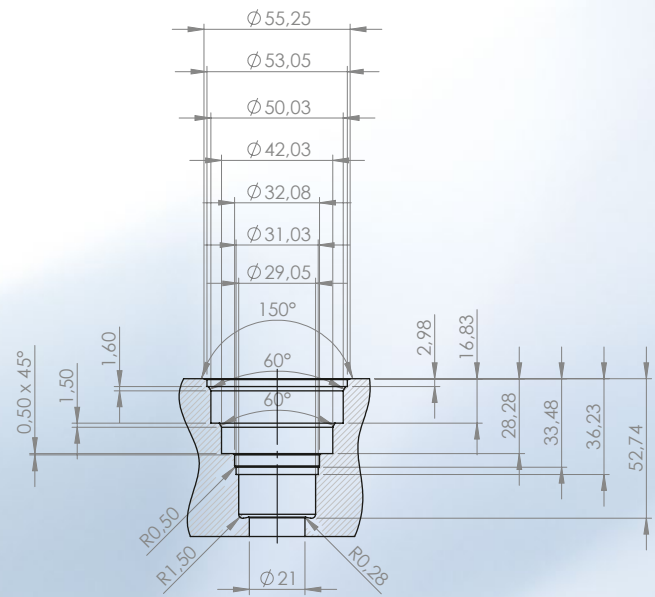

Mehrere Operationen in einem Werkzeug vereint

1. Unterschiedliche Aufbohrdurchmesser
2. Unterschiedliche Fasenbearbeitungen
3. Unterschiedliche Planbearbeitungen

Several operations combined in one tool

1. Different drilling diameters
2. Different chamfering operations
3. Different spot facing operations

Vorteile

- Reduzierung der Haupt- und Nebenzeiten auf 8 s
- Verbesserung der Oberflächenqualität der Kontur
- Erhöhung der Prozesssicherheit durch kurze Späne
- Erhöhung der Standzeit

Advantages

- Reduction of the main and auxiliary times to 8 s
- Improvement of the surface quality of the contour
- Increase in process reliability due to short chips
- Increase of tool life



Bearbeitungsbeispiel

Production example

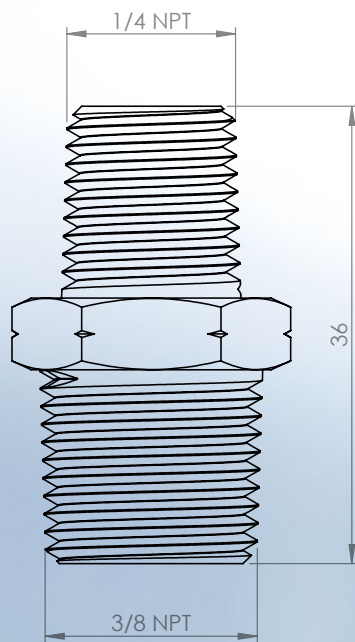

Werkstück: Doppelnippel-Verschraubung

Werkzeug:	Glockengewindefräser GFG-WFE
Werkstoff:	1.4301
Drehzahl:	n = 1.200 min ⁻¹
Vorschub _{gewindefräsen} :	f _{z gewindefräsen} = 0,1 mm
Bearbeitungszeit:	t = 6 s
Standzeit:	30.000 Stück
Nachschliff:	3x möglich

Workpiece: double nipple screw fitting

Tool:	Shell type thread milling cutter GFG-WFE
Material:	1.4301
Cutting speed:	n = 1,200 rpm
Feed rate _{thread milling} :	f _{z thread milling} = 0.1 mm
Machining time:	t = 6 s
Tool life:	30,000 pieces
Regrinds:	3x possible

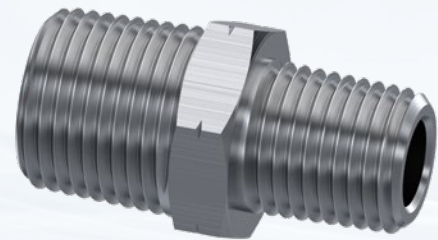

Details

1. HSK-C 40 für den Einsatz auf einer Rundtaktmaschine
2. 6x VHM Wechselfräseinsätze WFE D12x15,3xNPT18 TiCN
3. 6x Spanschraube für Wechselfräseinsätze
4. Offene Bauweise für beste Späneabfuhr

Details

1. HSK-C 40 for use on a rotary transfer machine
2. 6x solid carbide indexable thread milling insert WFE D12x15,3xNPT18 TiCN
3. 6x clamping screw for thread milling inserts
4. Open design for best chip removal

Vorteile

- Reduzierung der Haupt- und Nebenzeiten auf 6 s
- Verbesserung der Oberflächenqualität des Gewindes
- Erhöhung der Flexibilität durch Wechselfräseinsätze
- Erhöhung der Standzeit
- Reduzierung der Werkzeugkosten durch mehrmaliges Nachschleifen der Wechselfräseinsätze

Advantages

- Reduction of the main and auxiliary times to 6 s
- Improvement of the surface quality of the thread
- Increase of flexibility due to indexable thread milling inserts
- Increase of tool life
- Reduction of tool costs due to repeated regrinding of the indexable thread milling inserts

Bearbeitungsbeispiel

Production example

Werkstück: Fitting Winkel

Werkzeug: Präzisions-Schneideisen HSSE
Schäl., geläppt, nitriert
Werkstoff: Cuphin (bleifreies Messing)
Drehzahl: $n = 120 \text{ min}^{-1}$
Bearbeitungszeit: $t = 4 \text{ s}$
Standzeit: 3.000 Stück

Workpiece: fitting angle

Tool: Precision thread cutting die HSSE
spiral entry, lapped, nitrided
Material: Cuphin (lead free brass)
Cutting speed: $n = 120 \text{ rpm}$
Machining time: $t = 4 \text{ s}$
Tool life: 3,000 pieces

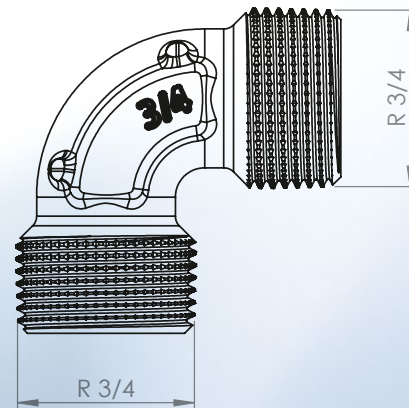

Details

1. Maschinenseitige VDI Schnittstelle
2. Präzisions-Schneideisen R3/4" HSSE, Schäl., geläppt, nitriert
3. Rändelrad
4. Kombinationswerkzeug mit modularem Werkzeugaufbau

Details

1. VDI interface machine-side
2. Precision thread cutting die R3/4" HSSE, spiral entry, lapped, nitrided
3. Knurling tool
4. Combination tool with a modular tool design

Vorteile

- Reduzierung der Haupt- und Nebenzeiten auf 4 s
- Vereinen von zwei Arbeitsgängen in einem Werkzeug
- Einstellmöglichkeit der Rändelstärke

Advantages

- Reduction of the main and auxiliary times to 4 s
- Combining 2 operations in one tool
- Possibility to adjust the knurl thickness

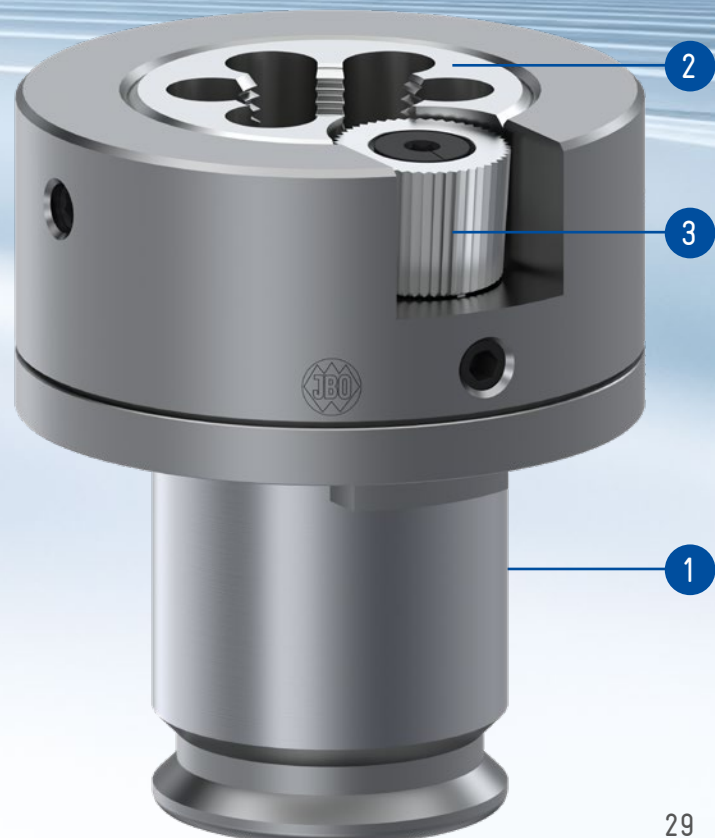

M MF MJ EG M
G Rc, R Pg
UNC UNF UN UNJF
NPT NPTF
M MF M keg. M taper
G BSW BSF DIN 477 R, BA, Pg
UNC UNF UNEF UN, UNS
NPSM NPT NPTF Tr, Rd
M MF
G BSW BSF R, Pg MF-EL
UNC, UNF UNEF UN, UNS UNJC UNJF
NPT NPTF Tr EG

Bearbeitungsbeispiel

Production example

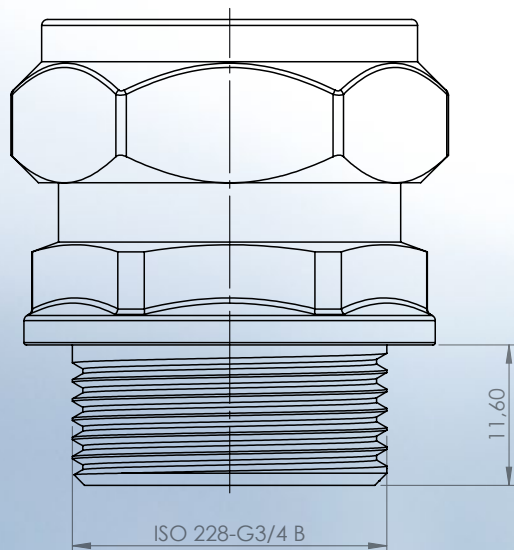

Werkstück: Fitting Reduzierung

Werkzeug:	Präzisions-Glockenform-Schneideisen HSSE Schäl, geläppt, nitriert mit DLC Beschichtung
Werkstoff:	Cuphin (bleifreies Messing)
Drehzahl:	$n = 300 \text{ min}^{-1}$
Bearbeitungszeit:	$t = 5 \text{ s}$
Standzeit:	20.000 Stück

Workpiece: fitting reduction

Tool:	Precision bell form type thread cutting die HSSE, spiral entry, lapped, nitrided with DLC coating
Material:	Cuphin (lead free brass)
Cutting speed:	$n = 300 \text{ rpm}$
Machining time:	$t = 5 \text{ s}$
Tool life:	20,000 pieces



Details

1. Schneideisenhalter mit Zylinderschaft
2. Präzisions-Glockenform-Schneideisen G3/4" HSSE, Schäl, geläppt, nitriert mit DLC Beschichtung und Innenkühlung
3. Modularer Werkzeugaufbau

Details

1. Tool holder with cylindrical shank
2. Precision-bell form type thread cutting die G3/4" HSSE, spiral entry, lapped, nitrided with DLC coating and internal coolant
3. Modular tool design

Vorteile

- Reduzierung der Haupt- und Nebenzeiten auf 5 s
- Verringerung der Reibwerte zwischen Werkzeug und Werkstück
- Innere Kühlschmiermittelzufuhr direkt an die Schneide
- Erhöhung der Standzeit

Advantages

- Reduction of the main and auxiliary times to 5 s
- Reduction of friction values between tool and workpiece
- Internal coolant supply directly to the cutting edge
- Increase of tool life

Bearbeitungsbeispiel

Production example

Werkstück: Implantat Plattensystem

Werkzeug: VHM Gewindefräser GFZ D1,8x3xSo0,6
Werkstoff: Ti6Al4V Titan Grade 5
Schnittgeschw. fräsen: V_c fräsen = 40 m/min
Vorschub fräsen: f_z fräsen = 0,05 mm
Bearbeitungszeit: t = 2 s

Workpiece: implant plating system

Tool: Solid carbide thread milling cutter
GFZ D1,8x3xSo0,6
Material: Ti6Al4V Titanium Grade 5
Cutting speed milling: V_c milling = 40 m/min
Feed rate milling: f_z milling = 0.05 mm
Machining time: t = 2 s

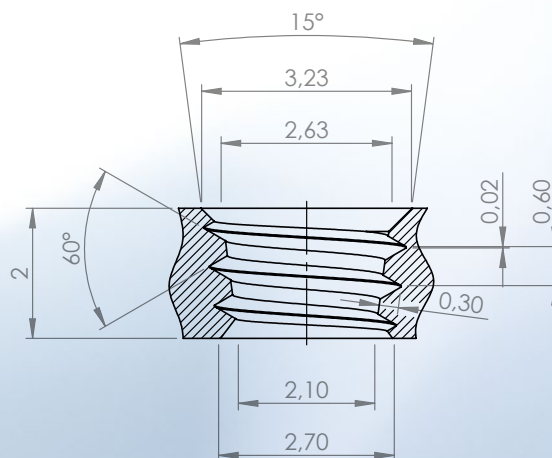

Details

1. Teilweise einziges zugelassenes Fertigungsverfahren
2. Vollprofiliges Fräsen des Gewindes
3. Keine Schmutznester in denen sich Bakterien ansammeln können

Details

1. Partially the only approved manufacturing process
2. Full profile milling of the thread
3. No dirt pockets in which bacteria can accumulate

Vorteile

- Reduzierung der Haupt- und Nebenzeiten auf 2 s
- Verringerung der Reibwerte zwischen Werkzeug und Werkstück
- Mehrgängiges Gewinde möglich
- Erhöhung der Standzeit

Advantages

- Reduction of the main and auxiliary times to 2 s
- Reduction of friction values between tool and workpiece
- Multi-start thread possible
- Increase of tool life



M
MF
MJ
EG M

G
Rc, R
Pg

UNC
UNF
UN
UNJF

NPT
NPTF



M
MF
M keg.
M taper

G
BSW
BSF
DIN 477
R, BA, Pg

UNC
UNF
UNEF
UN, UNS

NPSM
NPT
NPTF
Tr, Rd



M
MF

G
BSW
BSF
R, Pg
MF-EL

UNC, UNF
UNEF
UN, UNS
UNJC
UNJF

NPT
NPTF
Tr
EG

Bearbeitungsbeispiel

Production example

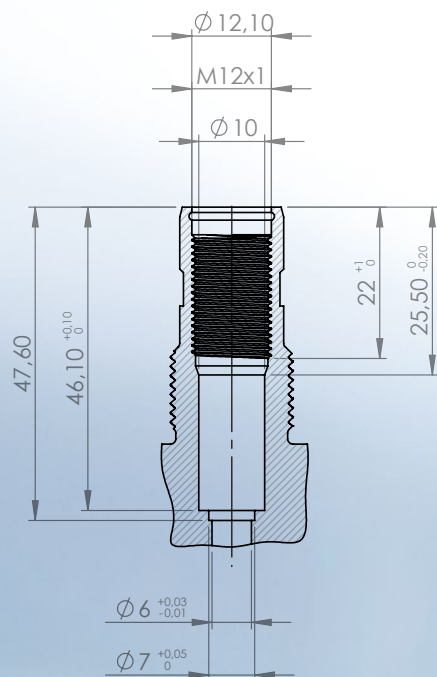

Mindesteinschraubtiefe
Minimum depth of engagement



Werkstück: Drosselventil

Prüfmittel: Koaxialitätsprüfdorn

Sondergewindelehre zum Prüfen der Koaxialität der Bohrungen zum Innengewinde.

Workpiece: throttle valve

Testing equipment: Coaxiality plug gauge

Special thread gauge for checking the coaxiality of the drill holes to the internal thread.

Mehrere Prüfoperationen in einem Prüfmittel vereint

1. Prüfen des Gewindes M 12 x 1
2. Prüfen der Koaxialität M 12 x 1 – $\varnothing 10$, $\varnothing 7$, $\varnothing 6$

Combining several inspection operations in one device

1. Checking thread M 12 x 1
2. Checking coaxiality M 12 x 1 – $\varnothing 10$, $\varnothing 7$, $\varnothing 6$

Vorteile

- Reduzierung der Prüfzeiten auf ein Minimum
- Nur ein Prüfmittel notwendig
- Prüfvorgang direkt in der Maschine

Advantages

- Reduction of the checking times to a minimum
- Only one inspection device necessary
- Inspection process directly in the machine

Bearbeitungsbeispiel

Production example

Werkstück: Zylinderkopf

Messmittel:	MultiCheck Digital
Ablesegenauigkeit:	0,01 mm
Wiederholgenauigkeit:	0,01 mm
Fehlergrenzen:	0,04 mm
Schutzart:	IP54
	5 – staubgeschützt
	4 – allseitiger Spritzwasserschutz

Workpiece: cylinder head

Inspection device:	MultiCheck Digital
Accuracy of reading:	0.01 mm
Repeatability:	0.01 mm
Error limits:	0.04 mm
Protection:	IP54
	5 – dustproof
	4 – protected against splashing water on each side

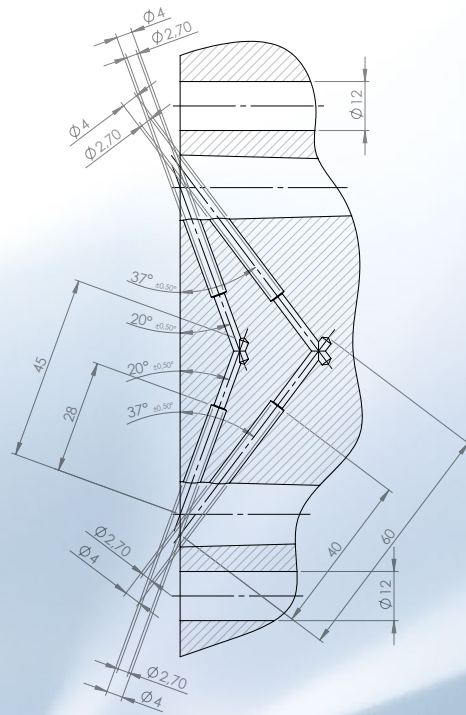

Mehrere Prüfoperationen in einem Prüfmittel vereint

1. Prüfen der Bohrungen $\varnothing 4$ im Winkel von 37° und 20°
2. Messen der Bohrungstiefe $\varnothing 4$

Combining several inspection operations in one device

1. Checking drilled holes $\varnothing 4$ at an angle of 37° and 20°
2. Measuring the depth of the drilled hole $\varnothing 4$

Vorteile

- Reduzierung der Prüf- und Messzeiten auf ein Minimum
- Nur ein Prüf- und Messmittel notwendig
- Prüfvorgang direkt in der Maschine

Advantages

- Reduction of the measuring and checking times to a minimum
- Only one device necessary
- Inspection process directly in the machine



M
MF
MJ
EG M

G
Rc, R
Pg

UNC
UNF
UN
UNJF

NPT
NPTF



M
MF
M keg.
M taper

G
BSW
BSF
DIN 477
R, BA, Pg

UNC
UNF
UNEF
UN, UNS

NPSM
NPT
NPTF
Tr, Rd



M
MF

G
BSW
BSF
R, Pg
MF-EL

UNC, UNF
UNEF
UN, UNS
UNJC
UNJF

NPT
NPTF
Tr
EG

Anwendungsbeispiel

Application example

Messaufgabe:

Bestimmung der Position und Lage des Gewindes an einer angeschweissten Mutter.

Measuring task:

Determination of the position and location of the thread on a welded nut.



Details

1. Koordinatenmessdorn mit Steigungsverzug im Gewinde für M 10
2. Stützt sich an zwei Gewindeflanken ab
3. Bestimmung der Position und Winkligkeit eines Innengewindes mittels 3D-Messmaschine

Details

1. Coordinate gauge rod with pitch correction in the thread for M 10
2. Supports itself on two thread flanks
3. Determination of the position and angularity of an internal thread by means of a 3D measuring machine

Anwendung:

Der Koordinatenmessdorn wird in das Gewinde eingeschraubt, bis er sich über den Steigungsverzug im Gewinde an den Gewindeflanken abstützt. Anschließend kann mit einer 3D-Messmaschine die Position und die Winkligkeit des Gewinde bestimmt werden.

Application:

The coordinate gauge rod is screwed into the thread until it is supported on the thread flanks via the pitch correction in the thread. Then the position and angularity of the thread can be determined with a 3D measuring machine.



Erläuterungen zum Order-Code

Key to order code

Bitte bestellen Sie Varianten der im Katalog mit Artikel-Nummer enthaltenen Standardprodukte mit dem Order-Code.
Please order variants of the standard products contained in the catalogue with article number by using the order-code.

Sie möchten 1 Stück Vollhartmetall-Gewindefräser Art.-Nr. 301284 jedoch mit Zyl.-Schaft HB.
You need 1 piece solid carbide thread milling cutter with art.-no. 301284 but with straight shank HB.

GFM A M 12 x 1 T HB

ORDER-CODE → GFM A M →								T				F
d ₁ Fräser Nenn-Ø Cutter nom. Ø ↓	P mm ↓	Ü ≥ für Gew.-Ø for thread Ø	l ₁	l ₂	d ₂	l ₄ Nutz- länge use length	z Nuten- zahl No. of flutes	blank uncoated	TiCN		Ti	
								Art.-Nr.	€	Art.-Nr.	€	Art.-Nr.
8	0,8	5	16	64	8	16	4	307425	255,00	308854	279,00	301011
10	0,5	3	16	70	10	25	4	300648	305,00	310415	334,00	301011
10	0,75	5	16	70	10	25	4	300649	305,00	304502	334,00	301011
10	1,25	8	16	70	10	25	4	301011	263,00	301375	288,00	301011
12	1	6	20	80	12	31	4	300480	298,00	301284	328,00	301011
12	1,5	10	20	80	12	31	4	300482	270,00	301358	300,00	301011
12	2	14	20	80	12	31	4	300481	281,00	311007	311,00	301011
16	1,5	10	25	90	16	40	5	300633	337,00	301393	368,00	301011
16	2	14	25	90	16	40	5	301014	347,00	301350	378,00	301011
16	2,5	18	25	90	16	40	5	301015	372,00	311008	403,00	301011
20	3	24	33	105	20	50	5	301016	479,00	311009	514,00	301011

Per Klick auf die Artikelnummer gelangen Sie zum jeweiligen Datenblatt mit allen technischen Informationen.
Click on the article number to access the respective data sheet with all technical information..

Zyl.-Schaft nach DIN 6535 HB oder HE, kein Zuschlag, keine Rücknahme möglich
Straight shank according to DIN 6535 HB or HE, no extra charge, no withdrawal possible





M
MF
MJ
EG M

G
Rc, R
Pg

UNC
UNF
UN
UNJF

NPT
NPTF



M
MF
M keg.
M taper

G
BSW
BSF
DIN 477
R, BA, Pg

UNC
UNF
UNEF
UN, UNS

NPSM
NPT
NPTF
Tr, Rd



M
MF

G
BSW
BSF
R, Pg
MF-EL

UNC, UNF
UNEF
UN, UNS
UNJC
UNJF

NPT
NPTF
Tr
EG





Gewindefräser

Thread Milling Cutters



M
MF
MJ
EG M

G
Rc, R
Pg

UNC
UNF
UN
UNJF

NPT
NPTF



M
MF
M keg.
M taper

G
BSW
BSF
DIN 477
R, BA, Pg

UNC
UNF
UNEF
UN, UNS

NPSM
NPT
NPTF
Tr, Rd



M
MF

G
BSW
BSF
R, Pg
MF-EL

UNC, UNF
UNEF
UN, UNS
UNJC
UNJF

NPT
NPTF
Tr
EG



M
MF
MJ
EG M

G
Rc, R
Pg

UNC
UNF
UN
UNJF

NPT
NPTF



M
MF
M keg.
M taper

G
BSW
BSF
DIN 477
R, BA, Pg

UNC
UNF
UNEF
UN, UNS

NPSM
NPT
NPTF
Tr, Rd



M
MF

G
BSW
BSF
R, Pg
MF-EL

UNC, UNF
UNEF
UN, UNS
UNJC
UNJF

NPT
NPTF
Tr
EG

Gewindefräser

Thread Milling Cutters

Allgemeine Information General Information

Übersicht Gewindefräser <small>Overview Thread Milling Cutters</small>	Seite/page 40
Optionale Fräsermodifikationen <small>Optional cutter modifications</small>	Seite/page 42
JBOtronic - Programmiersoftware <small>JBOtronic - programming software</small>	Seite/page 43
Allgemeine Vorteile des GewindefräSENS <small>General advantages of thread milling</small>	Seite/page 44
Kunden-individuelle Sonder-GewindefräSER <small>Special Client-Specific Thread Milling Cutters</small>	Seite/page 46
Ablaufschritte für GewindefräSER <small>Operation sequences for Thread Milling Cutters</small>	Seite/page 48
Gewindekernlöcher für das GewindefräSEN <small>Diameters of drilled holes for thread milling</small>	Seite/page 52
Fehlerbehebung <small>Troubleshooting</small>	Seite/page 55
Anwendungsempfehlungen und Schnittdaten <small>Reference of application and cutting data</small>	Seite/page 56

	Seite/page		Seite/page
M		Rc/R	
Metrisches ISO-Gewinde ISO metric thread		Kegeliges Whitworth-Rohrgewinde Tapered Whitworth pipe thread	
GF <small>SHARK</small>	67	GFM	100
GF	68	Pg	
GFS	72	Stahlpanzerrohr-Gewinde Steel conduit thread	
GFM <small>SHARK</small>	67	GFM	101
GFM	79	UNC	
GFM für Außengewinde <small>for external threads</small>	80	UNC-Grobgewinde Unified national coarse thread	
GFH	81	GF	102
GFT-H	82	GFS	105
GFE	83	UNF	
GFT <small>SHARK</small>	84	UNF-Feingewinde Unified national fine thread	
BGF	85	GF	103
BGF 3	88	GFS	108
BGFS	91	UN	
GFW-Q	96	UN-Gewinde Unified national thread	
MF		GFM	111
Metrisches ISO-Feingewinde ISO metric fine thread		GFT <small>SHARK</small>	112
GFM <small>SHARK</small>	67	UNJF	
GF	71	UNJF-Feingewinde UNJF Unified national fine thread	
GFS	76	GF	104
GFM	79	NPT	
GFM für Außengewinde <small>for external threads</small>	80	NPT-Kegeliges Amerikanisches Rohrgewinde American Standard taper pipe thread	
BGF	92	GF	113
BGF 3	95	GFM	114
BGFS	91	NPTF	
GFW-Q	96	NPTF-Kegeliges Amerikanisches Rohrgewinde American Standard taper pipe thread	
MJ		GF	114
MJ-Gewinde Luft- und Raumfahrt MJ thread Aerospace		GFM	115
GF	70	G	
G		Whitworth-Rohrgewinde Whitworth pipe thread	
GF	97	GF	97
GFS	98	GFS	98
GFM	99	GFM	99

VHM-Gewindefräser

Solid Carbide Thread Milling Cutters

GF SHARK



VHM-Gewindefräser

Universell einsetzbares Hochleistungswerkzeug mit Linksspiralnuten, ungleichen Spiralsteigungen und hoher Zähnezahl für hohe Oberflächengüten und überragende Standmengen.

Solid carbide thread milling cutter

Universal high performance tool with left-hand spiral flutes, unequal spiral pitches and a large number of teeth for high surface quality and outstanding tool life.

GF



VHM-Gewindefräser

Universell einsetzbares Werkzeug zur kostengünstigen Fertigung von Innengewinden.

Solid carbide thread milling cutter

Universal tool for cost effective production of internal screw threads.

GFS



VHM-Gewindefräser mit Senkstufe

Universell einsetzbares Werkzeug zur kombinierten Fertigung von Innengewinden mit Ansenkung. Steigerung der Produktivität durch Senken und Gewindefräsen in einem Arbeitszyklus ohne Werkzeugwechsel.

Solid carbide thread milling cutter with chamfering capability

Universal tool for cutting internal screw threads. Increased productivity resulting from combined thread milling and chamfering in a single machining cycle without tool changing.

GFM SHARK



VHM-Gewindefräser

Universell einsetzbares Hochleistungswerkzeug zur Fertigung eines großen Gewinde-Ø-Bereichs mit gleicher Steigung. Linksspiralnuten, ungleichen Spiralsteigungen und hoher Zähnezahl für hohe Oberflächengüten und überragende Standmengen.

Solid carbide wide range thread milling cutter

Universal high performance tool for cutting a wide range of thread-Ø with an identical pitch. Left-hand spiral flutes, unequal spiral pitches and a large number of teeth for high surface quality and outstanding tool life.

GFM



VHM-Mehrbereichsgewindefräser

Universell einsetzbares Werkzeug zur Fertigung eines großen Gewinde-Ø-Bereichs mit gleicher Steigung.

Solid carbide wide range thread milling cutter

Universal tool for cutting a wide range of thread-Ø with identical pitch.

GFH



VHM-Gewindefräser für die Hartbearbeitung

Spezialisierte Variante des GF zur Fertigung von Innengewinden in vergütete bzw. gehärtete Stähle im Bereich von 54-63 HRC.

Solid carbide thread milling cutter for hard materials

Special version of GF cutter for cutting internal screw threads in tempered and hardened steels in the 54-63 HRC range.

GFT-H



VHM-Dreiprofilgewindefräser für die Hartbearbeitung

Spezialisierte Variante des GFT zur Fertigung von Innengewinden ab M 2 bis M 8 in vergütete bzw. gehärtete Stähle im Bereich von 54–63 HRC.

Solid carbide thread milling cutter with three rings of teeth for hard materials

Special version of GF cutter for cutting internal threads ranging from M 2 to M 8 in tempered and hardened steels in the 54–63 HRC range.

GFE



VHM-Einprofilgewindefräser

Universell einsetzbares Werkzeug für die Fertigung von Innengewinden ab M 1 bis M 3,5.

Solid carbide thread milling cutter with single ring of teeth

Universal tool for cutting internal threads ranging from M 1 to M 3.5.

GFT^{SHARK}



VHM-Dreiprofilgewindefräser

Universell einsetzbares Hochleistungswerkzeug mit den technologischen Eigenschaften des GF^{SHARK} für die Fertigung von Innengewinden ab M 1,2 bis M 20, UNC Nr.1 bis UNC 1/4" und UNF Nr.2 bis UNF 1/4".

Solid carbide thread milling cutter with three rings of teeth

Universally applicable high-performance tool with the technological properties of GF^{SHARK} for the production of internal threads from M 1.2 to M 20, UNC No.1 to UNC 1/4" and UNF No.2 to UNF 1/4".

BGF



VHM-Bohrgewindefräser

Werkzeug zur kombinierten Fertigung von Innengewinden mit Bohrung und Ansenkung. Maximale Produktivität durch Reduzierung der Nebenzeiten, da kein Werkzeugwechsel notwendig ist. Speziell zur Bearbeitung von NE Metallen.

Solid carbide drill thread milling cutter

Combines drilling with thread milling and chamfering in the production of internal threads. Maximises productivity by eliminating tool changing. Particularly suitable for machining non-ferrous metal.

BGF 3



VHM-Bohrgewindefräser mit 3 Schneiden

Optimierte Variante des BGF, vor allem geeignet zur Bearbeitung von kurzspanenden Werkstoffen. Dieses Werkzeug bietet eine höhere Leistung durch die größere Schneidenzahl und verbessertes Zentrierverhalten. Speziell zur Bearbeitung von Grauguss.

Solid carbide drill thread milling cutter with 3 flutes

Optimised version of the BGF tool, particularly suitable for machining materials that yield short chips. Because of the greater number of cutting edges, this tool offers enhanced performance with improved centring. Particularly suitable for machining cast iron.

BGFS



VHM-Zirkularbohrgewindefräser

Werkzeug zur kombinierten Fertigung von Bohrung und Gewinde in einem Arbeitsgang. Universell einsetzbar in Stählen, gehärteten Werkstoffen und NE-Metallen.

Solid carbide circular drill thread milling cutter

Tool for the combined production of bore and thread in one operation. Universally applicable in steels, hardened materials and non-ferrous metals.

GFW-Q



Wendeplattengewindefräser

Hochleistungswerkzeug für den universellen Einsatz in der Innengewindeherstellung eines großen Gewinde-Ø-Bereichs mit gleicher Steigung. Wendeplatten mit jeweils 4 nutzbaren Schneiden.

Indexable thread milling cutter

High performance tool for universal use in manufacture of internal screw threads in a wide range of thread-Ø with an identical pitch. Each insert has 4 useabel cutting edges.

Optionale Fräsermodifikationen

Optional cutter modifications

Diese Modifikationen werden in der Regel als Umarbeitung aus bestehenden Werkzeugen gefertigt, somit sind sehr kurze Lieferzeiten möglich. These modifications are carried out normally on already existing tools, so that they can be supplied at very short notice.

KS



Die Option KS (seitlich erodierte Kühlkanäle) gewährleistet insbesondere bei Durchgangsgewindebohrungen, dass das Werkzeug optimal mit Kühlschmierstoff versorgt wird. Es befindet sich in jeder Spannute eine über die Frästeillänge gleichmäßig verteilte Anzahl von Bohrungen. (blau hervorgehoben)

Modifikation möglich für: GF/GFS/GFM/BGF/BGF 3

The KS option (lateral eroded coolant channels) ensures that the cutter receives an optimum supply of cutting oil, particularly for through holes. The coolant holes are spaced evenly along the cutter length, with one hole per flute. (highlighted in blue)

Modification is possible on: GF/GFS/GFM/BGF/BGF 3

KR



Die Option KR (Kühlrillen) bietet Vorteile bei der Bearbeitung von Durchgangsgewindebohrungen. Die Anzahl der Kühlrillen ist durch die Anzahl der Spannuten bestimmt, kann aber nach Absprache geändert werden. (blau hervorgehoben)

Modifikation möglich für: GF/GFS/GFM/BGF/BGF 3

The KR option (coolant channels) is advantageous for cutting threads in through holes. The number of cooling channels is determined by the number of flutes, but can be changed on consultation. (highlighted in blue)

Modification is possible on: GF/GFS/GFM/BGF/BGF 3

U



Die Option U (45° Senkfase am Bohrteil) ermöglicht es, das Kernloch zirkular anzufasen. Dies ist vor allem nützlich, wenn die Gewindelänge zwischen zwei Abmessungen liegen soll, aber kein Sonderwerkzeug erwünscht ist. (blau hervorgehoben)

Modifikation möglich für: BGF/BGF 3

The U option (45° chamfering at drill bit) enables chamfering at drill bit of the drilled hole to be carried out by circular interpolation. This is especially useful when the thread length is to be between two cutter sizes and a special tool should to be avoided. (highlighted in blue)

Modification is possible on: BGF/BGF 3

ST



Die Option ST (Stirnschneiden) ermöglicht es, mit dem Gewindefräswerkzeug eine Planspiegelung z.B. an Gusswerkstücken durchzuführen. (blau hervorgehoben)

Modifikation möglich für: GF/GFS/GFM

The ST option (facing teeth) enables the thread milling cutter to carry out spot facing, for instance on castings. (highlighted in blue)

Modification is possible on: GF/GFS/GFM

STS



Die Option STS (Stirnschneiden mit 45° Senkfase), ermöglicht es, mit dem Gewindefräswerkzeug eine Planspiegelung z. B. an Gusswerkstücken durchzuführen und anschließend das Kernloch zirkular anzusenken. (blau hervorgehoben)

Modifikation möglich für: GF/GFS/GFM

The STS option (facing and 45° chamfering teeth) enables the thread milling cutter to carry out spot facing, for instance on castings, followed by chamfering of the drilled hole by circular interpolation. (highlighted in blue)

Modification is possible on: GF/GFS/GFM

ES



Die Option ES (Entgratschneide) entfernt bei der Bearbeitung den letzten, unvollständigen Gang des Gewindes und beugt somit einer eventuellen Gratbildung an dieser Stelle des Muttergewindes vor. (blau hervorgehoben)

Modifikation möglich für: GF/GFS/BGF/BGF 3

The ES option (deburring teeth) removes the last incomplete thread and therefore prevents the possible formation of a burr at that location. (highlighted in blue)

Modification is possible on: GF/GFS/BGF/BGF 3

AZR



Die Option AZR (vollständig ausgesetzte Zahnreihen) ermöglicht bei besonders großen L/D-Verhältnissen die Verringerung der beim Bearbeiten auftretenden Schnittkräfte und vermindert dadurch die Abdrängung des Werkzeugs. Zusätzliche Fräszyklen sind erforderlich. (blau hervorgehoben)

Modifikation möglich für: GF/GFS/GFM/BGF/BGF 3

The AZR option (entire omission of alternate rings of teeth) reduces the cutting forces, particularly with large L/D ratios, thus reducing cutter deflection. Several successive thread milling cycles are necessary. (highlighted in blue)

Modification is possible on: GF/GFS/GFM/BGF/BGF 3

AZ



Die Option AZ (ausgesetzte Zähne) ähnelt der Option AZR, jedoch werden die Zähne versetzt ausgesetzt. Somit ist ein kleinerer Vorschub erforderlich, aber es müssen nicht mehrere Zyklen gefräst werden. (blau hervorgehoben)

Modifikation möglich für: GF/GFS/GFM/BGF/BGF 3

The AZ option (omission of teeth) is similar to option AZR, but the omission of teeth alternates from side to side. This reduces the feed that can be employed, but several successive thread milling cycles are not necessary.

(highlighted in blue) Modification is possible on: GF/GFS/GFM/BGF/BGF 3

JB0tronic - Programmiersoftware

JB0tronic - programming software

Um das Arbeiten mit Gewindefräsern für unsere Kunden und jene die es werden wollen, so einfach wie möglich zu gestalten, haben wir die Software JB0tronic entwickelt.

Mit der JB0tronic ist das Erstellen von Gewindefräsprogrammen für DIN-/Heidenhain-basierte NC-Steuerungen höchst effizient möglich. Beginnend bei der Auswahl der meist verwendeten Standardgewinde (M, MF, EG M, G, Pg, UNC, UNF, UNEF, NPT, NPTF und Rc) oder der Definition von zylindrischen/kegeligen Sondergewinden über die Auswahl des Werkstückstoffs, des Werkzeugs, der Maschinensteuerung, den Bearbeitungsoptionen, den Schnittwerten bis hin zu der automatischen Berechnung des NC-Codes, werden Sie von der JB0tronic bestmöglich unterstützt.

To make the process of working with thread milling cutters as simple as possible for our existing and future customers, we have developed the software tool JB0tronic.

JB0tronic enables thread milling programmes for DIN/Heidenhain based NC Controls to be generated with the utmost efficiency. Starting with selection of the most frequently used standard threads (M, MF, EG M, G, Pg, UNC, UNF, UNEF, NPT, NPTF and Rc) or the definition of cylindrical/tapered non-standard threads, through selection of the workpiece material, the tool, machine control, machining options and cutting values, to automatic calculation of the NC code: JB0tronic provides you with the best possible support every step of the way.



M MF MJ EG M
G Rc, R Pg
UNC UNF UN UNJF
NPT NPTF
M MF M keg. M taper
G BSW BSF DIN 477 R, BA, Pg
UNC UNF UNEF UN, UNS
NPSM NPT NPTF Tr, Rd
M MF
G BSW BSF R, Pg MF-EL
UNC, UNF UNEF UN, UNS UNJC UNJF
NPT NPTF Tr EG

Allgemeine Vorteile des GewindefräSENS

- Die Gewindemaßhaltigkeit ist beeinflussbar
- Ein Werkzeugbruch führt nicht unmittelbar zum Werkstückausschuss
- Geringerer Leistungsbedarf als beim Gewindebohren
- Kurze Bearbeitungszeiten durch hohe Schnittgeschwindigkeiten
- Sehr gute Oberflächenqualität der gefräSTen Gewinde
- Keine Spanproblematik durch kurze FrässpäNe
- Mit einem Werkzeug sind Rechts- und Linksgewinde in Grund- und Durchganglochausführung herstellbar
- Durch geringe FräSkräfte ist die Bearbeitung dünnwandiger Werkstücke möglich
- Schnittgeschwindigkeit und Vorschub können individuell an den zu bearbeitenden Werkstoff angepasst werden
- Kein Drehrichtungswechsel der Hauptspindel notwendig
- Keine speziellen Gewindeschneidfutter erforderlich, Standardfutter ist ausreichend
- Exakte Gewindetiefen sind herstellbar
- Bei Grundlochgewinden ist eine Gewindefertigung bis nahe dem Bohrungsende möglich
- Gewindeanfang ist über NC-Programm eindeutig bestimmt



Spezielle Vorteile des GewindefräSers mit Senkstufe Typ GFS

- Hohe Produktivität durch Senken und GewindefräSEN mit einem Werkzeug ohne Werkzeugwechsel
- Verkürzung der Haupt- und Nebenzeiten
- Einsparung von Magazinplätzen im Werkzeugmagazin
- Entfall von Werkzeugwechselzeiten
- Zeiteinsparung beim RüSTen



Spezielle Vorteile des MehrbereichgewindefräSers Typ GFM

- Bei gleicher Steigung große Gewindedurchmesserbereiche bearbeitbar
- Geringe Werkzeugkosten bei großen Gewinden
- Durch den Halseinstich zwischen Schneidteil und Schaft kann, durch einen zweiten FräSdurchgang, ein wesentlich tieferes Gewinde erzeugt werden, als bei FräSern ohne Halseinstich



Spezielle Vorteile der Ein- / DreiprofilgewindefräSer Typ GFE / GFT

- Kleine Gewinde ab M 1 sind herstellbar
- Tiefe Gewinde (3xD) sind problemlos herstellbar



Spezielle Vorteile des BohrgewindefräSers Typ BGF / BGF 3

- Hohe Produktivität durch Bohren, Senken und GewindefräSEN mit einem Werkzeug ohne Werkzeugwechsel
- Verkürzung der Haupt- und Nebenzeiten
- Einsparung von zwei Magazinplätzen im Werkzeugmagazin
- Einschraublänge ist nur 1,3 x Steigung kürzer als die Bohrtiefe
- Grund- und Durchgangslöcher sind herstellbar



Spezielle Vorteile der ZirkularbohrgewindefräSer Typ BGFS

- Ermöglicht den Einsatz von ZirkularbohrgewindefräSerk Werkzeugen in weichen und gehärteten Stahlwerkstoffen und NE-Metallen
- Hohe Produktivität durch Bohren und GewindefräSEN mit einem Werkzeug ohne Werkzeugwechsel
- Verkürzung der Nebenzeiten

General advantages of thread milling

- Threads to different tolerance classes can be produced with same cutter
- Tool breakage does not necessarily entail scrapping of the workpiece
- Less power needed for cutting internal threads
- Short machining times due to high cutting speeds
- Excellent thread surface finish
- Short chips, hence no chip problems
- Right and left hand threads can be produced in blind or through holes version by the same cutter
- Low cutting forces enable threads to be cut in thin wall workpieces
- Cutting speeds and feeds can be matched individually to workpiece material
- No torque change of the main spindle necessary
- No special tapping chucks required, standard chucks suffice
- Threads can be cut to exact depth
- For blind holes, thread production is possible up to near the end of the hole
- Start of thread accurately determined by NC programme



Special advantages of type GFS thread milling cutter with chamfering capability

- High productivity due to chamfering and thread milling with just one tool without tool changing
- Reduction of both cutting time and non-cutting time in machining cycle
- Saving of tool magazine places
- Elimination of tool changing time
- Reduction of setting time



Special advantages of type GFM wide range thread milling cutter

- A wide range of diameters with an equal pitch can be machined
- Low tooling costs for large threads
- Due to the neck recess between the cutter teeth and the shank, a much deeper thread can be produced by a second milling cycle than with cutters without neck recess



Special advantages of type GFE / GFT thread milling cutters

- Small diameter threads starting at M 1 can be produced
- Deep threads (3xD) can be produced



Special advantages of type BGF / BGF 3 drill thread milling cutters

- High productivity due to drilling, chamfering and thread milling with just one tool without tool changing
- Reduction of cutting and non-cutting times in machining cycle
- Saving of two tool magazine places
- Fully cut thread only 1.3 x pitch shorter than depth of drilled hole
- Both blind and through holes can be drilled and threaded



Special advantages of circular drill thread milling cutters type BGFS

- Allows the usage of circular drill thread milling cutter in soft and hardened steel materials and non-ferrous metals
- High productivity due to drilling and thread milling with just one tool without tool changing
- Reduction of non-cutting times in machining cycle



	M MF MJ EG M
	G Rc, R Pg
	UNC UNF UN UNJF
	NPT NPTF
	M MF M keg. M taper
	G BSW BSF DIN 477 R, BA, Pg
	UNC UNF UNEF UN, UNS
	NPSM NPT NPTF Tr, Rd
	M MF
	G BSW BSF R, Pg MF-EL
	UNC, UNF UNEF UN, UNS UNJC UNJF
	NPT NPTF Tr EG

Kunden-individuelle Sonder-Gewindefräser

Special Client-Specific Thread Milling Cutters

1 Gewindefräser zur synchronen Herstellung von zwei Außengewinden M 28 x 0,5 mit Entfernung des unvollständigen Gewindeganges an beiden Gewinden.

Thread milling cutter for synchronous production of two external threads M 28 x 0,5 with removal of the incomplete first thread on both threads.

2 Gewindefräser GFZ D2,6x7xSo1,75 P0,875 (2-gängig) zur Herstellung der Innengewinde an orthopädischen Chirurgieplatten.

Thread milling cutter GFZ D2.6x7xSo1.75 P0.875 (2-starts) for the production of internal threads on orthopaedic surgical plates.

3 Gewindefräser GFZ D16x19,9xM 2/D12x15,7xM 1,5 mit seitlichen Kühlkanälen zur Herstellung von Durchgangsgewinden M 28 x 2 und M 18 x 1,5.

Thread milling cutter GFZ D16x19.9xM 2/D12x15.7xM 1.5 with lateral cooling channels for the production of through hole threads M 28 x 2 and M 18 x 1.5.

4 Gewindefräser für Trapezgewinde Tr 9 x 2 nach DIN 103 mit versetzt ausgesetzten Zähnen.

Thread milling cutter for trapezoidal thread Tr 9 x 2 DIN 103 with mixed exposed teeth.



Die Anforderungen in der modernen Fertigung steigen und werden komplexer.

Wir analysieren Ihre Gewindebearbeitung und bieten eine Lösung für die Optimierung der Kosten und Qualität.

The demands on manufacturing nowadays are becoming ever more exacting and complex.

We analyse your screw thread production and offer solutions that optimise your costs and product quality.



1



2



3



4

5 PKD Gewindefräser GFZ D12x22xM1,5 mit seitlichen Kühlkanälen zur Herstellung eines Gewindes M 18 x 1,5.

PCD thread milling cutter GFZ D12x22xM1.5 with lateral cooling channels for producing a thread M 18 x 1.5.

6 Gewindefräser für Trapezgewinde Tr 30 x 6.

Thread milling cutter for trapezoidal thread Tr 30 x 6.

7 PKD-Gewindefräser GFZ D25x31xS3 zur Herstellung eines Ölfiltergewindes S 80 x 3 mit Schutzsenkung.

PCD thread milling cutter GFZ D25x31xS3 for the production of an oil filter thread S 80 x 3 with protection countersink.

8 Gewindefräser mit Stirnaussparung nach ISO 13486-1 / JASO F402 / DIN 74235.

Thread milling cutter with front recess in accordance to ISO 13486-1 / JASO F402 / DIN 74235.



M
MF
MJ
EG M

G
Rc, R
Pg

UNC
UNF
UN
UNJF

NPT
NPTF



M
MF
M keg.
M taper

G
BSW
BSF
DIN 477
R, BA, Pg

UNC
UNF
UNEF
UN, UNS

NPSM
NPT
NPTF
Tr, Rd



M
MF

G
BSW
BSF
R, Pg
MF-EL

UNC, UNF
UNEF
UN, UNS
UNJC
UNJF

NPT
NPTF
Tr
EG

Ablaufschritte für Gewindefräser

Operation sequences for Thread Milling Cutters

GF/GF^{SHARK}/GFM^{SHARK}/GFH

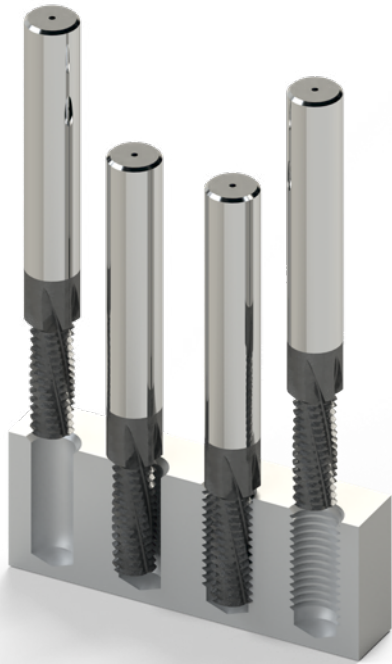

1 2 3 4

Ablaufschritte für Gewindefräser

- 1 Werkzeug fährt auf Startposition zentrisch über die Bohrung
- 2 Beginn des GewindefräSENS mit Einfahrschleife
- 3 FräSEN des Gewindes mit anschließender Ausfahrschleife
- 4 Verfahren auf Startposition und beenden des Bearbeitungsvorganges

Operation sequences for thread milling cutters

- 1 Tool moves to initial position above centre of hole
- 2 Thread milling starts with cutter entry path
- 3 Thread milling followed by exit path
- 4 Return to initial position and end of machining cycle

GFS



1 2 3 4 5

Ablaufschritte für Gewindefräser mit Senkstufe

- 1 Werkzeug fährt auf Startposition zentrisch über die Bohrung
- 2 Ansenken der 90° Fase
- 3 Beginn des GewindefräSENS mit Einfahrschleife
- 4 FräSEN des Gewindes mit anschließender Ausfahrschleife
- 5 Verfahren auf Startposition und beenden des Bearbeitungsvorganges

Operation sequences for thread milling cutters with chamfering capability

- 1 Tool moves to initial position above centre of hole
- 2 90° chamfering
- 3 Thread milling starts with cutter entry path
- 4 Thread milling followed by exit path
- 5 Return to initial position and end of machining cycle



GFM/GFW-Q



1 2 3 4

Ablaufschritte für Gewindefräser mit Halseinstich

- 1 Werkzeug fährt auf Startposition zentrisch über die Bohrung
- 2 Beginn des GewindefräSENS mit Einfahrschleife
- 3 FräSEN des Gewindes mit anschließender Ausfahrschleife
- 4 Verfahren auf Startposition und beenden des Bearbeitungsvorganges

Operation sequences for thread milling cutters with recessed neck

- 1 Tool moves to initial position above centre of hole
- 2 Thread milling starts with cutter entry path
- 3 Thread milling followed by exit path
- 4 Return to initial position and end of machining cycle



1 2 3 4 5 6

Ablaufschritte für Gewindefräser mit Halseinstich und Versetzen in der Tiefe

- 1 Werkzeug fährt auf Startposition zentrisch über die Bohrung
- 2 Beginn des GewindefräSENS mit Einfahrschleife
- 3 FräSEN des Gewindes mit anschließender Ausfahrschleife.
Zustellung in der Z-Richtung um die entsprechende Tiefe
- 4 Beginn des zweiten GewindefräSEnvorganges mit Einfahrschleife
- 5 FräSEN des Gewindes mit anschließender Ausfahrschleife
- 6 Verfahren auf Startposition und beenden des Bearbeitungsvorganges

Operation sequences for thread milling cutters with recessed neck and vertical displacement

- 1 Tool moves to initial position above centre of hole
- 2 Thread milling starts with cutter entry path
- 3 Thread milling ends with cutter exit path
Z-axis displacement to required depth
- 4 Second thread milling process starts with cutter entry path
- 5 Thread milling followed by exit path
- 6 Return to initial position and end of machining cycle



M
MF
MJ
EG M

G
Rc, R
Pg

UNC
UNF
UN
UNJF

NPT
NPTF



M
MF
M keg.
M taper

G
BSW
BSF
DIN 477
R, BA, Pg

UNC
UNF
UNEF
UN, UNS

NPSM
NPT
NPTF
Tr, Rd



M
MF

G
BSW
BSF
R, Pg
MF-EL

UNC, UNF
UNEF
UN, UNS
UNJC
UNJF

NPT
NPTF
Tr
EG

GFE/GFT^{SHARK}



1 2 3 4 5 6

Ablaufschritte für Ein- und Dreiprofilgewindefräser

- ① Werkzeug fährt auf Startposition zentrisch über die Bohrung
- ② Verfahren auf Gewinde- \varnothing Fertigungsmaß
- ③ Zirkulares Gewindefräsen auf Gewindetiefe
- ④ Zirkulares Gewindefräsen auf Gewindetiefe
- ⑤ Beenden des Gewindefräsvorganges mit einer Ausfahrtschleife
- ⑥ Verfahren auf Startposition und beenden des Bearbeitungsvorganges

Operation sequences for thread milling cutters with single ring or three rings of teeth

- ① Tool moves to initial position above centre of hole
- ② Move to finished thread diameter
- ③ Thread milling with helical interpolation down to required thread depth
- ④ Thread milling with helical interpolation down to required thread depth
- ⑤ End of thread milling process with exit path
- ⑥ Return to initial position and end of machining cycle



GFT-H



1 2 3 4 5 6

Ablaufschritte für Dreiprofilgewindefräser für die Hartbearbeitung

- ① Werkzeug fährt auf Startposition zentrisch über die Bohrung
- ② Werkzeug fährt auf maximale Gewindetiefe in die Bohrung ein
- ③ Beginn des Gewindefräsens mit Einfahrtschleife
- ④ Zirkulares Gewindefräsen Richtung Werkstückoberfläche
- ⑤ Zirkulares Gewindefräsen Richtung Werkstückoberfläche
- ⑥ Verfahren auf Startposition und Beenden des Bearbeitungsvorganges

Operation sequences for thread milling cutters with three rings of teeth for hard materials

- ① Tool moves to initial position above centre of hole
- ② Tool moves into the hole to the maximum thread depth
- ③ Thread milling starts with cutter entry path
- ④ Thread milling with helical interpolation towards the workpiece surface
- ⑤ Thread milling with helical interpolation towards the workpiece surface
- ⑥ Return to initial position and end of machining cycle

BGFS



- 1
- 2
- 3
- 4
- 5
- 6

Ablaufschritte für Zirkularbohrgewindefräser

- 1 Werkzeug fährt auf Startposition zentrisch über die Gewindeposition
- 2 Beginn mit zirkularer Fräsbewegung
- 3 Zirkulares Bohrgewindefräsen auf Gewindetiefe
- 4 Zirkulares Bohrgewindefräsen auf Gewindetiefe
- 5 Beenden des Gewindefräsvorganges mit einer Ausfahrtschleife
- 6 Verfahren auf Startposition und beenden des Bearbeitungsvorganges

Operation sequences for circular drill thread milling cutters

- 1 Tool moves to initial position above centre of thread position
- 2 Start with circular milling operation
- 3 Thread milling with helical interpolation down to required thread depth
- 4 Thread milling with helical interpolation down to required thread depth
- 5 End of thread milling process with exit path
- 6 Return to initial position and end of machining cycle



BGF/BGF 3



- 1
- 2
- 3
- 4
- 5
- 6
- 7
- 8

Ablaufschritte für Bohrgewindefräser

- 1 Werkzeug fährt auf Startposition zentrisch über die Gewindeposition
- 2 Bohren des Kernloches mit Ansenken der 90° Fase
- 3 Rückzug des Werkzeuges aus der Bohrung zum Entspannen
- 4 Verfahren auf Startposition des Gewindefräszyklus
- 5 Beginn des Gewindefräsens mit Einfahrtschleife
- 6 Fräsen des Gewindes
- 7 Beenden des Gewindefräsvorganges mit einer Ausfahrtschleife
- 8 Verfahren auf Startposition und beenden des Bearbeitungsvorganges

Operation sequences for drill thread milling cutters

- 1 Tool moves to initial position above centre of thread position
- 2 Drilling of core diameter and 90° chamfering
- 3 Retraction of cutter from drilled hole for ejection of chips
- 4 Move to start position of thread milling cycle
- 5 Thread milling starts with cutter entry path
- 6 Thread milling
- 7 End of thread milling process with exit path
- 8 Return to initial position and end of machining cycle



Gewindekernlöcher für das Gewindefräsen

Zylindrische Gewindearten

Diameters of drilled holes
for thread milling
Parallel thread types

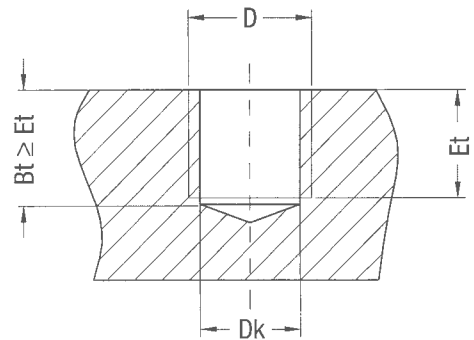

M		MF	G			PG	
Nenn-Ø nom. Ø	Bohr-Ø bore Ø		Nenn-Ø nom. Ø	Bohr-Ø bore Ø	Nenn-Ø nom. Ø	Bohr-Ø bore Ø	
D [mm]	Dk [mm]		D [mm]	Dk [mm]	D [mm]	Dk [mm]	
1	0,75	<p>Berechnungsbeispiel: Kernloch-Ø für M 17 x 1,5: Berechnung: Bohr-Ø = Nenn-Ø - Steigung Bohr-Ø = 17 mm - 1,5 mm = 15,5 mm</p> <p>Calculation example: Minor Ø for M 17 x 1.5: Calculation: bore Ø = nom. Ø - pitch bore Ø = 17 mm - 1.5 mm = 15.5 mm</p>	1/16"	7,72	6,7	7	11,3
1,1	0,85		1/8"	9,73	8,7	9	14,0
1,2	0,95		1/4"	13,16	11,7	11	17,3
1,4	1,10		3/8"	16,66	15,2	13,5	19,0
1,6	1,25		1/2"	20,96	18,9	16	21,2
1,8	1,45		5/8"	22,91	20,9	21	26,9
2	1,6		3/4"	26,44	24,4	29	35,5
2,5	2,1		7/8"	30,20	28,2	36	45,5
3	2,5		1"	33,25	30,6	42	52,5
3,5	2,9		1 1/8"	37,90	35,3	48	57,8
4	3,3		1 1/4"	41,91	39,3		
5	4,2		1 3/8"	44,32	41,7		
6	5,0		1 1/2"	47,80	45,2		
7	6,0		1 3/4"	53,75	51,1		
8	6,8		2"	59,61	57,0		
9	7,8		2 1/4"	65,71	63,1		
10	8,5		2 1/2"	75,18	72,6		
12	10,3		2 3/4"	81,53	78,9		
14	12,0		3"	87,88	85,3		
16	14,0		3 1/4"	93,98	91,3		
18	15,5	3 1/2"	100,33	97,7			
20	17,5						
22	19,5						
24	21,0						
27	24,0						
30	26,5						
33	29,5						
36	32,0						
39	35,0						
42	37,5						
45	40,5						
48	43,0						
52	47,0						
56	50,5						
60	54,5						
64	58,0						

Gewindekernlöcher für das Gewindefräsen

Zylindrische Gewindearten

Diameters of drilled holes
for thread milling
Parallel thread types

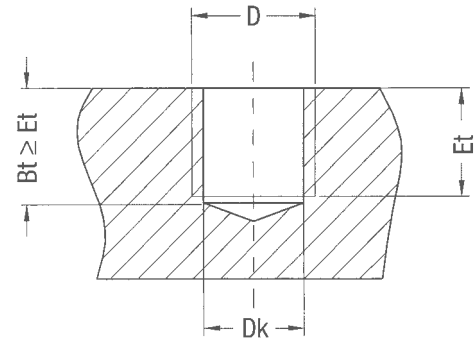

UNC			UNF			UNEF			UN		
Nenn-Ø nom. Ø	Nenn-Ø nom. Ø	Bohr-Ø bore Ø	Nenn-Ø nom. Ø	Nenn-Ø nom. Ø	Bohr-Ø bore Ø	Nenn-Ø nom. Ø	Nenn-Ø nom. Ø	Bohr-Ø bore Ø			
	D [mm]	Dk [mm]		D [mm]	Dk [mm]		D [mm]	Dk [mm]			
Nr. 1	1,85	1,5	Nr. 0	1,52	1,3	Nr. 12	5,49	4,7			
Nr. 2	2,18	1,8	Nr. 1	1,85	1,6	1/4"	6,35	5,6			
Nr. 3	2,51	2,1	Nr. 2	2,18	1,9	5/16"	7,94	7,2			
Nr. 4	2,84	2,3	Nr. 3	2,51	2,1	3/8"	9,53	8,8			
Nr. 5	3,18	2,6	Nr. 4	2,84	2,4	7/16"	11,11	10,2			
Nr. 6	3,51	2,8	Nr. 5	3,18	2,6	1/2"	12,70	11,8			
Nr. 8	4,17	3,4	Nr. 6	3,51	2,9	9/16"	14,29	13,3			
Nr. 10	4,83	3,8	Nr. 8	4,17	3,5	5/8"	15,88	14,9			
Nr. 12	5,49	4,5	Nr. 10	4,83	4,1	11/16"	17,46	16,4			
1/4"	6,35	5,1	Nr. 12	5,49	4,6	3/4"	19,05	17,8			
5/16"	7,94	6,6	1/4"	6,35	5,5	13/16"	20,64	19,4			
3/8"	9,53	8,0	5/16"	7,94	6,9	7/8"	22,23	21,0			
7/16"	11,11	9,4	3/8"	9,53	8,5	15/16"	23,81	22,6			
1/2"	12,70	10,8	7/16"	11,11	9,9	1"	25,40	24,2			
9/16"	14,29	12,2	1/2"	12,70	11,5	1 1/16"	26,99	25,6			
5/8"	15,88	13,6	9/16"	14,29	12,9	1 1/8"	28,58	27,2			
3/4"	19,05	16,6	5/8"	15,88	14,5	1 3/16"	30,16	28,8			
7/8"	22,23	19,5	3/4"	19,05	17,5	1 1/4"	31,75	30,4			
1"	25,40	22,2	7/8"	22,23	20,5	1 5/16"	33,34	32,0			
1 1/8"	28,58	25,0	1"	25,40	23,3	1 3/8"	34,93	33,6			
1 1/4"	31,75	28,2	1 1/8"	28,58	26,5	1 1/2"	38,10	36,7			
1 3/8"	34,93	30,7	1 1/4"	31,75	29,7	1 9/16"	39,69	38,3			
1 1/2"	38,10	33,9	1 3/8"	34,93	32,9	1 5/8"	41,28	39,9			
1 3/4"	44,45	39,4	1 1/2"	38,10	36,0	1 11/16"	42,86	41,5			
2"	50,80	45,2									
2 1/4"	57,15	51,5									
2 1/2"	63,50	57,1									
2 3/4"	69,85	63,5									
3"	76,20	69,8									
3 1/4"	82,55	76,2									
3 1/2"	88,90	82,5									
3 3/4"	95,25	88,9									
4"	101,60	95,2									

Berechnungsbeispiel:
Kernloch-Ø für UN 2"- 8:
Berechnung:
Bohr-Ø = Nenn-Ø - Steigung
Bohr-Ø = 50,8 mm - 3,175 mm
= 47,7 mm

Calculation example:
Minor Ø for UN 2"- 8:
Calculation:
bore Ø = nom. Ø - pitch
bore Ø = 50.8 mm - 3.175 mm
= 47.7 mm



Gewidekernlöcher für das Gewidefräsen

Kegelige Gewidearten

Diameters of drilled holes
for thread milling
Tapered thread types

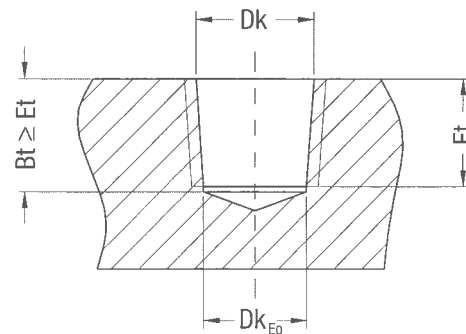

Rc					NPT/NPTF			
Nenn-Ø nom. Ø	Nenn-Ø nom. Ø	Gew.- länge thread length	Bohr-Ø zyl. bore Ø cyl.	Bohr-Ø keg. bore Ø tapered	Nenn-Ø nom. Ø	Gew.- länge thread length	Bohr-Ø zyl. bore Ø cyl.	Bohr-Ø keg. bore Ø tapered
	D [mm]	min. Et [mm]	Dk _{E0} [mm]	Dk [mm]		min. Et [mm]	Dk _{E0} [mm]	Dk [mm]
1/16"	7,72	7,4	6,1	6,56	1/16"	8,1	6,10	6,39
1/8"	9,73	7,4	8,1	8,57	1/8"	8,1	8,40	8,74
1/4"	13,16	11,0	10,8	11,45	1/4"	11,9	10,90	11,36
3/8"	16,66	11,4	14,2	14,95	3/8"	12,2	14,30	14,80
1/2"	20,96	15,0	17,7	18,63	1/2"	16,0	17,80	18,32
3/4"	26,44	16,3	23,1	24,12	3/4"	16,4	23,10	23,67
1"	33,25	19,1	29,1	30,29	1"	19,7	28,90	29,69
1 1/4"	41,91	21,4	37,6	38,95	1 1/4"	20,2	37,70	38,45
1 1/2"	47,80	21,4	43,5	44,85	1 1/2"	20,2	43,70	44,52
2"	59,61	25,7	55,1	56,66	2"	20,6	55,60	56,56
2 1/2"	75,18	30,2	70,3	72,23	2 1/2"	31,0	66,30	67,62
3"	87,88	33,3	82,8	84,93	3"	33,1	82,30	83,52
4"	113,03	39,3	107,6	110,07				
5"	138,43	43,6	132,7	135,47				
6"	163,83	43,6	158,1	160,87				

Bei kegeligen Gewidearten ist der Bohr-Ø auf die angegebene Gewidelänge bezogen. Deshalb muss bei abweichender Gewidelänge der Bohr-Ø angepasst werden.

Berechnungsbeispiel für die Bohrtiefe Bt (zyl. Bohrung):
 $Bt = Et + 2 \times P$ (Gewidesteigung in mm)

For tapered threads, the bore diameter is related to the specified thread length. Therefore, for a differing thread length, the bore Ø must be adapted.

Calculation example for the bore depth Bt (cyl. drilled hole):
 $Bt = Et + 2 \times P$ (thread pitch in mm)

Für die Richtigkeit dieser Daten kann, insbesondere bei Sonderwerkzeugen, keine Gewähr seitens der Fa. Johs. Boss übernommen werden.

The Johs. Boss company does not warrant that the above data are appropriate, particularly for special thread milling cutters.

NPT/NPTF: Die Anwendung von Spiralbohrern der aufgelisteten Durchmesser nach ANSI sichert kein vollständiges Gewideprofil über die gesamte Einschraublänge von Hand (L1).

NPT/NPTF: The use of twist drills with the diameters listed according to ANSI does not ensure complete thread profiles over the entire screw in length by hand (L1).



Fehlerbehebung

Troubleshooting

Problem problem	mögliche Ursachen possible causes
<p>Rattern, Vibrationen</p> <p>Chattering, vibrations</p>	<ul style="list-style-type: none"> • Werkstückspannung schlecht • Maschinenstabilität nicht ausreichend • Vorschub zu gering • Werkzeugspannung zu steif (Schrumpffutter) • Auskraglänge zu groß • Spiralwinkel des Werkzeugs zu klein • bad workpiece clamping • machine stability insufficient • feed to low • tool clamping too stiff (shrink chuck) • overhang is too large • helix angle of the tool is too small
<p>Schneidkantenausbrüche</p> <p>Chipped cutting edges</p>	<ul style="list-style-type: none"> • Vorschub zu hoch • Werkstückspannung schlecht • Maschinenstabilität nicht ausreichend • Rundlauf schlecht • feed too high • bad workpiece clamping • machine stability insufficient • concentricity bad
<p>Übermäßiger Verschleiß</p> <p>Excessive wear</p>	<ul style="list-style-type: none"> • Schnittgeschwindigkeit zu hoch • Vorschub zu klein • Werkstückspannung schlecht • Maschinenstabilität nicht ausreichend • Auskraglänge zu groß • Spiralwinkel des Werkzeugs zu groß • cutting speed too high • feed too small • bad workpiece clamping • machine stability insufficient • overhang too large • helix angle of the tool is too large
<p>Gewinde wird konisch</p> <p>Tapered thread shape</p>	<ul style="list-style-type: none"> • Vorschub zu hoch • Auskraglänge zu groß • Spiralwinkel des Werkzeugs zu groß • feed too high • overhang too large • helix angle of the tool is too large
<p>Werkzeugbruch (GF)</p> <p>Tool breakage (GF)</p>	<ul style="list-style-type: none"> • Vorschub zu hoch • Fehler im CNC-Programm • Kernlochbohrung zu klein • feed too high • error in the CNC programme • core hole bore too small
<p>Werkzeugbruch (BGF)</p> <p>Tool breakage (BGF)</p>	<ul style="list-style-type: none"> • Vorschub beim Gewindefräsen zu hoch • Vorschub beim Bohren zu hoch • Spänestau beim Bohren • Fehler im CNC-Programm • feed too high during thread milling • feed for drilling too high • chip congestion during drilling • error in the CNC programme



M
MF
MJ
EG M

G
Rc, R
Pg

UNC
UNF
UN
UNJF

NPT
NPTF



M
MF
M keg.
M taper

G
BSW
BSF
DIN 477
R, BA, Pg

UNC
UNF
UNEF
UN, UNS

NPSM
NPT
NPTF
Tr, Rd



M
MF

G
BSW
BSF
R, Pg
MF-EL

UNC, UNF
UNEF
UN, UNS
UNJC
UNJF

NPT
NPTF
Tr
EG



Anwendungsempfehlungen und Schnittdaten

Reference of application and cutting data



sehr gut geeignet
highly suitable
 gut geeignet
well suitable
 geeignet
suitable

Material	material	Festig- keit [N/mm ²]	Härte hard- ness [HB]	Härte hard- ness [HRC]	Werkstoff- beispiel workpiece example	Werk- stoffnr. workpiece material no.	GF			GF TiCN		
							v _c [m/min]	f _z [mm]		v _c [m/min]	f _z [mm]	
								d ≤ 7 mm	d > 7 mm		d ≤ 7 mm	d > 7 mm
Stahlwerkstoffe/Steels	Magnetweicheisen, unlegierte Qualitätsstähle magnetic soft iron, non alloy high grade steels	≤ 400	≤ 120		RF60 St37-3G	1.1015 1.0116	70 - 90 70 - 90	0,02 - 0,06 0,02 - 0,06	0,06 - 0,13 0,06 - 0,13	105 - 125 105 - 125	0,02 - 0,06 0,02 - 0,06	0,06 - 0,13 0,06 - 0,13
	Automatenstähle, Allg. Baustähle free-cutting steels, general structural steels	≤ 600	≤ 200		9SMnPb28 St44-2	1.0718 1.0044	95 - 115 70 - 80	0,02 - 0,06 0,02 - 0,06	0,06 - 0,13 0,06 - 0,13	140 - 160 100 - 120	0,02 - 0,06 0,02 - 0,06	0,06 - 0,13 0,06 - 0,13
	Stahlguss, Automatenstähle, Legierte Stähle, Baustähle steel castings, free-cutting steels, alloy steels, general structural steels	≤ 850	≤ 250		GS-20Mn5N St70-2	1.1120 1.0070	95 - 115 75 - 95	0,02 - 0,06 0,02 - 0,06	0,06 - 0,13 0,06 - 0,13	140 - 160 115 - 135	0,02 - 0,06 0,02 - 0,06	0,06 - 0,13 0,06 - 0,13
	Einsatz-, Vergütungs-, Nitrier-, Kalt- arbeitsstähle case hardening steels, quenched & tempered steels, nitriding steels, cold work steels	≤ 1100	≤ 350		16MnCr5 100Cr6	1.7131 1.2067	55 - 75 50 - 70	0,02 - 0,06 0,02 - 0,06	0,06 - 0,13 0,06 - 0,13	85 - 105 75 - 95	0,02 - 0,06 0,02 - 0,06	0,06 - 0,13 0,06 - 0,13
	Nitrier-, Kaltarbeits-, Warmarbeits-, Ver- gütungsstähle nitriding steels, cold work steels, hot working steels, quenched & tempered steels	≥ 1200	≥ 350		X155CrVMo12-1 42CrMo4	1.2379 1.7225	35 - 55 50 - 70	0,01 - 0,05 0,02 - 0,06	0,05 - 0,10 0,06 - 0,13	55 - 75 75 - 95	0,01 - 0,05 0,02 - 0,06	0,05 - 0,10 0,06 - 0,13
	gehärtete Stähle bis 44 HRC hardened steels ≤ 44 HRC	≤ 1400		≤ 44	59CrV4 X45CrNiMo4	1.2242 1.2767	25 - 45 25 - 45	0,01 - 0,05 0,01 - 0,05	0,05 - 0,10 0,05 - 0,10	40 - 60 40 - 60	0,01 - 0,05 0,01 - 0,05	0,05 - 0,10 0,05 - 0,10
	gehärtete Stähle bis 63 HRC hardened steels ≤ 63 HRC	≤ 2200		≤ 66	X165CrV12 200CrMn8	1.2201 1.2129						
	rostfreie Stähle stainless steels	≤ 850	≤ 250		X6CrAl13 X6CrTi17	1.4002 1.4510	30 - 50 25 - 45	0,01 - 0,05 0,01 - 0,05	0,05 - 0,10 0,05 - 0,10	45 - 65 40 - 60	0,01 - 0,05 0,01 - 0,05	0,05 - 0,10 0,05 - 0,10
	austenitische Stähle austenitic steels	≤ 850	≤ 250		X5CrNi18-10 X6CrNiTi18-10	1.4301 1.4541	25 - 45 20 - 40	0,01 - 0,05 0,01 - 0,05	0,05 - 0,10 0,05 - 0,10	40 - 60 30 - 50	0,01 - 0,05 0,01 - 0,05	0,05 - 0,10 0,05 - 0,10
	ferritisch-austenitische, ferritische oder martensitische Stähle ferritic-austenitic, ferritic or martensitic steels	≤ 1100	≤ 300		X45CrMoV15 X38Cr13	1.4116 1.4031	20 - 40 20 - 40	0,01 - 0,05 0,01 - 0,05	0,05 - 0,10 0,05 - 0,10	30 - 50 30 - 50	0,01 - 0,05 0,01 - 0,05	0,05 - 0,10 0,05 - 0,10
Guss/Cast iron	Gusseisen mit Lamellengraphit grey cast iron	≤ 320	≤ 300		GG20 GG35	0.6020 0.6035	80 - 100 65 - 85	0,03 - 0,07 0,02 - 0,06	0,07 - 0,15 0,06 - 0,13	120 - 140 95 - 115	0,03 - 0,07 0,02 - 0,06	0,07 - 0,15 0,06 - 0,13
	Gusseisen mit Kugelgraphit nodular cast iron	≤ 800			GGG-40 GGG-80	0.7040 0.7080	60 - 80 55 - 75	0,03 - 0,07 0,02 - 0,06	0,07 - 0,15 0,06 - 0,13	80 - 110 85 - 105	0,03 - 0,07 0,02 - 0,06	0,07 - 0,15 0,06 - 0,13
	Temperguss malleable cast iron	≤ 420	≤ 230		GTW-35-04 GTW-S38-12	0.8035 0.8038	55 - 75 60 - 80	0,03 - 0,07 0,03 - 0,07	0,07 - 0,15 0,07 - 0,15	85 - 105 90 - 110	0,03 - 0,07 0,03 - 0,07	0,07 - 0,15 0,07 - 0,15
Titan/Titanium	Reintitan pure titanium	≤ 450			Ti Ti	3.7025 3.7035	20 - 40 15 - 35	0,02 - 0,05 0,02 - 0,05	0,05 - 0,10 0,05 - 0,10	35 - 55 30 - 50	0,02 - 0,05 0,02 - 0,05	0,05 - 0,10 0,05 - 0,10
	Titanlegierungen titanium alloys	≤ 900			Ti-6Al-4V Ti-3Al	3.7164 3.7065	10 - 30 10 - 30	0,02 - 0,05 0,02 - 0,05	0,05 - 0,10 0,05 - 0,10	20 - 40 20 - 40	0,02 - 0,05 0,02 - 0,05	0,05 - 0,10 0,05 - 0,10
	Titanlegierungen titanium alloys	≤ 1200			TiAl4Mo4Sn2Si0.5		10 - 30	0,02 - 0,05	0,05 - 0,10	20 - 40	0,02 - 0,05	0,05 - 0,10
Magnesium	Magnesium-Knetlegierungen wrought magnesium alloys	≤ 310			MgMn2 MgAl8Zn	3.5200 3.5812	325 - 345 305 - 325	0,05 - 0,14 0,05 - 0,14	0,14 - 0,20 0,14 - 0,20	470 - 490 440 - 460	0,05 - 0,14 0,05 - 0,14	0,14 - 0,20 0,14 - 0,20
	Magnesium-Gusslegierungen cast magnesium alloys	≤ 170			G-MgAl8Zn1 G-MgAl6	3.5912 3.5662	325 - 345 305 - 325	0,05 - 0,14 0,05 - 0,14	0,14 - 0,20 0,14 - 0,20	470 - 490 440 - 460	0,05 - 0,14 0,05 - 0,14	0,14 - 0,20 0,14 - 0,20
Aluminium	Aluminium unlegiert aluminium	≤ 140	≤ 50		Al99 Al99,8	3.0205 3.0285	280 - 300 290 - 310	0,05 - 0,14 0,05 - 0,14	0,14 - 0,20 0,14 - 0,20	400 - 420 415 - 435	0,05 - 0,14 0,05 - 0,14	0,14 - 0,20 0,14 - 0,20
	Aluminium-Knetlegierungen wrought aluminium alloys	≤ 520	≤ 140		AlCuMg2 AlZnMgCu1,5	3.1355 3.4365	280 - 300 250 - 270	0,05 - 0,14 0,05 - 0,14	0,14 - 0,20 0,14 - 0,20	400 - 420 365 - 385	0,05 - 0,14 0,05 - 0,14	0,14 - 0,20 0,14 - 0,20
	Alu-Gusslegierungen < 12% Si aluminium alloy castings < 12% Si	≤ 210	≤ 110		G-AlSi10Mg G-AlMg5Si	3.2381 3.3261	325 - 345 305 - 325	0,05 - 0,14 0,05 - 0,14	0,14 - 0,20 0,14 - 0,20	470 - 490 440 - 460	0,05 - 0,14 0,05 - 0,14	0,14 - 0,20 0,14 - 0,20
	Alu-Gusslegierungen > 12% Si aluminium alloy castings > 12% Si	≤ 300	≤ 90		G-AlSi12	3.2581	315 - 335	0,05 - 0,14	0,14 - 0,20	455 - 475	0,05 - 0,14	0,14 - 0,20
Kupfer/Copper	Kupfer-Zinn-Legierungen copper-zinc alloys (brass)	≤ 470			CuZn40 CuZn38Pb1,5	2.0360 2.0371	170 - 190 190 - 210	0,05 - 0,14 0,05 - 0,14	0,14 - 0,20 0,14 - 0,20	250 - 270 275 - 295	0,05 - 0,14 0,05 - 0,14	0,14 - 0,20 0,14 - 0,20
	Kupfer-Zinn-Legierungen copper-tin alloys (bronze)	≤ 700			CuSn6 CuSn8	2.1020 2.1030	175 - 195 190 - 210	0,05 - 0,14 0,05 - 0,14	0,14 - 0,20 0,14 - 0,20	255 - 275 275 - 295	0,05 - 0,14 0,05 - 0,14	0,14 - 0,20 0,14 - 0,20
	Kupfer-Aluminium-Legierungen copper-aluminium alloys	≤ 600			CuAl8 CuAl9Mn2	2.0920 2.0960	170 - 190 175 - 195	0,05 - 0,14 0,05 - 0,14	0,14 - 0,20 0,14 - 0,20	250 - 270 255 - 275	0,05 - 0,14 0,05 - 0,14	0,14 - 0,20 0,14 - 0,20
Nickel	warmfeste Nickellegierungen heat resistant nickel alloys	≤ 850			NiCu30Fe	2.4360	20 - 40	0,01 - 0,04	0,04 - 0,07	30 - 50	0,01 - 0,04	0,04 - 0,07
	hochwarmfeste Nickellegierungen highly heat resistant nickel alloys	≤ 1400			Inconel® 718	2.4668	5 - 15	0,01 - 0,03	0,03 - 0,06	10 - 30	0,01 - 0,03	0,03 - 0,06
	hochwarmfeste Nickellegierungen highly heat resistant nickel alloys	≤ 1400			Haynes® 25		5 - 15	0,01 - 0,03	0,03 - 0,06	15 - 35	0,01 - 0,03	0,03 - 0,06

Die angegebenen Werte sind Erfahrungswerte, die bei optimalen Bedingungen realisierbar sind. Diese Werte sind abhängig von Gewindeart, Gewindetiefe, Maschine (Steifigkeit, Aufspannung etc.) und Ausführung des Werkzeuges. Je nach Bedarf müssen diese Werte den Gegebenheiten angepasst werden.



GF TiAlN			GFS			GFS TiCN			GFS TiAlN			GFM	
v _c	f _z [mm]		v _c	f _z [mm]		v _c	f _z [mm]		v _c	f _z [mm]		v _c	f _z [mm]
	[m/min]	d ≤ 7 mm		d > 7 mm	[m/min]		d ≤ 7 mm	d > 7 mm		[m/min]	d ≤ 7 mm		
120 - 140 120 - 140	0,02 - 0,06 0,02 - 0,06	0,06 - 0,13 0,06 - 0,13	70 - 90 70 - 90	0,02 - 0,06 0,02 - 0,06	0,06 - 0,13 0,06 - 0,13	105 - 125 105 - 125	0,02 - 0,06 0,02 - 0,06	0,06 - 0,13 0,06 - 0,13	120 - 140 120 - 140	0,02 - 0,06 0,02 - 0,06	0,06 - 0,13 0,06 - 0,13	70 - 90 70 - 90	0,10 - 0,16 0,10 - 0,16
165 - 185 115 - 135	0,02 - 0,06 0,02 - 0,06	0,06 - 0,13 0,06 - 0,13	95 - 115 70 - 80	0,02 - 0,06 0,02 - 0,06	0,06 - 0,13 0,06 - 0,13	140 - 160 100 - 120	0,02 - 0,06 0,02 - 0,06	0,06 - 0,13 0,06 - 0,13	165 - 185 115 - 135	0,02 - 0,06 0,02 - 0,06	0,06 - 0,13 0,06 - 0,13	95 - 115 70 - 80	0,10 - 0,16 0,10 - 0,16
165 - 185 135 - 155	0,02 - 0,06 0,02 - 0,06	0,06 - 0,13 0,06 - 0,13	95 - 115 75 - 95	0,02 - 0,06 0,02 - 0,06	0,06 - 0,13 0,06 - 0,13	140 - 160 115 - 135	0,02 - 0,06 0,02 - 0,06	0,06 - 0,13 0,06 - 0,13	165 - 185 135 - 155	0,02 - 0,06 0,02 - 0,06	0,06 - 0,13 0,06 - 0,13	95 - 115 75 - 95	0,10 - 0,16 0,10 - 0,16
100 - 120 90 - 110	0,02 - 0,06 0,02 - 0,06	0,06 - 0,13 0,06 - 0,13	55 - 75 50 - 70	0,02 - 0,06 0,02 - 0,06	0,06 - 0,13 0,06 - 0,13	85 - 105 75 - 95	0,02 - 0,06 0,02 - 0,06	0,06 - 0,13 0,06 - 0,13	100 - 120 90 - 110	0,02 - 0,06 0,02 - 0,06	0,06 - 0,13 0,06 - 0,13	55 - 75 50 - 70	0,10 - 0,16 0,10 - 0,16
65 - 85 90 - 110	0,01 - 0,05 0,02 - 0,06	0,05 - 0,10 0,06 - 0,13	35 - 55 50 - 70	0,01 - 0,05 0,02 - 0,06	0,05 - 0,10 0,06 - 0,13	55 - 75 75 - 95	0,01 - 0,05 0,02 - 0,06	0,05 - 0,10 0,06 - 0,13	65 - 85 90 - 110	0,01 - 0,05 0,02 - 0,06	0,05 - 0,10 0,06 - 0,13	35 - 55 50 - 70	0,08 - 0,14 0,10 - 0,16
50 - 70 50 - 70	0,01 - 0,05 0,01 - 0,05	0,05 - 0,10 0,05 - 0,10	25 - 45 25 - 45	0,01 - 0,05 0,01 - 0,05	0,05 - 0,10 0,05 - 0,10	40 - 60 40 - 60	0,01 - 0,05 0,01 - 0,05	0,05 - 0,10 0,05 - 0,10	50 - 70 50 - 70	0,01 - 0,05 0,01 - 0,05	0,05 - 0,10 0,05 - 0,10	25 - 45 25 - 45	0,08 - 0,14 0,08 - 0,14
55 - 75 50 - 70	0,01 - 0,05 0,01 - 0,05	0,05 - 0,10 0,05 - 0,10	30 - 50 25 - 45	0,01 - 0,05 0,01 - 0,05	0,05 - 0,10 0,05 - 0,10	45 - 65 40 - 60	0,01 - 0,05 0,01 - 0,05	0,05 - 0,10 0,05 - 0,10	55 - 75 50 - 70	0,01 - 0,05 0,01 - 0,05	0,05 - 0,10 0,05 - 0,10	30 - 50 25 - 45	0,08 - 0,14 0,08 - 0,14
50 - 70 35 - 55	0,01 - 0,05 0,01 - 0,05	0,05 - 0,10 0,05 - 0,10	25 - 45 20 - 40	0,01 - 0,05 0,01 - 0,05	0,05 - 0,10 0,05 - 0,10	40 - 60 30 - 50	0,01 - 0,05 0,01 - 0,05	0,05 - 0,10 0,05 - 0,10	50 - 70 35 - 55	0,01 - 0,05 0,01 - 0,05	0,05 - 0,10 0,05 - 0,10	25 - 45 20 - 40	0,08 - 0,14 0,08 - 0,14
35 - 55 35 - 55	0,01 - 0,05 0,01 - 0,05	0,05 - 0,10 0,05 - 0,10	20 - 40 20 - 40	0,01 - 0,05 0,01 - 0,05	0,05 - 0,10 0,05 - 0,10	30 - 50 30 - 50	0,01 - 0,05 0,01 - 0,05	0,05 - 0,10 0,05 - 0,10	35 - 55 35 - 55	0,01 - 0,05 0,01 - 0,05	0,05 - 0,10 0,05 - 0,10	20 - 40 20 - 40	0,08 - 0,14 0,08 - 0,14
140 - 160 110 - 130	0,03 - 0,07 0,02 - 0,06	0,07 - 0,15 0,06 - 0,13	80 - 100 65 - 85	0,03 - 0,07 0,02 - 0,06	0,07 - 0,15 0,06 - 0,13	120 - 140 95 - 115	0,03 - 0,07 0,02 - 0,06	0,07 - 0,15 0,06 - 0,13	140 - 160 110 - 130	0,03 - 0,07 0,02 - 0,06	0,07 - 0,15 0,06 - 0,13	80 - 100 65 - 85	0,12 - 0,18 0,10 - 0,16
105 - 125 100 - 120	0,03 - 0,07 0,02 - 0,06	0,07 - 0,15 0,06 - 0,13	60 - 80 55 - 75	0,03 - 0,07 0,02 - 0,06	0,07 - 0,15 0,06 - 0,13	90 - 110 85 - 105	0,03 - 0,07 0,02 - 0,06	0,07 - 0,15 0,06 - 0,13	105 - 125 100 - 120	0,03 - 0,07 0,02 - 0,06	0,07 - 0,15 0,06 - 0,13	60 - 80 55 - 75	0,12 - 0,18 0,10 - 0,16
100 - 120 105 - 125	0,03 - 0,07 0,03 - 0,07	0,07 - 0,15 0,07 - 0,15	55 - 75 60 - 80	0,03 - 0,07 0,03 - 0,07	0,07 - 0,15 0,07 - 0,15	85 - 105 90 - 110	0,03 - 0,07 0,03 - 0,07	0,07 - 0,15 0,07 - 0,15	100 - 120 105 - 125	0,03 - 0,07 0,03 - 0,07	0,07 - 0,15 0,07 - 0,15	55 - 75 60 - 80	0,12 - 0,18 0,12 - 0,18
40 - 60 35 - 55	0,02 - 0,05 0,02 - 0,05	0,05 - 0,10 0,05 - 0,10	20 - 40 15 - 35	0,02 - 0,05 0,02 - 0,05	0,05 - 0,10 0,05 - 0,10	35 - 55 30 - 50	0,02 - 0,05 0,02 - 0,05	0,05 - 0,10 0,05 - 0,10	40 - 60 35 - 55	0,02 - 0,05 0,02 - 0,05	0,05 - 0,10 0,05 - 0,10	20 - 40 15 - 35	0,10 - 0,16 0,10 - 0,16
25 - 45 25 - 45	0,02 - 0,05 0,02 - 0,05	0,05 - 0,10 0,05 - 0,10	10 - 30 10 - 30	0,02 - 0,05 0,02 - 0,05	0,05 - 0,10 0,05 - 0,10	20 - 40 20 - 40	0,02 - 0,05 0,02 - 0,05	0,05 - 0,10 0,05 - 0,10	25 - 45 25 - 45	0,02 - 0,05 0,02 - 0,05	0,05 - 0,10 0,05 - 0,10	10 - 30 10 - 30	0,10 - 0,16 0,10 - 0,16
25 - 45	0,02 - 0,05	0,05 - 0,10	10 - 30	0,02 - 0,05	0,05 - 0,10	20 - 40	0,02 - 0,05	0,05 - 0,10	25 - 45	0,02 - 0,05	0,05 - 0,10	10 - 30	0,10 - 0,16
540 - 560 505 - 525	0,05 - 0,14 0,05 - 0,14	0,14 - 0,20 0,14 - 0,20	325 - 345 305 - 325	0,05 - 0,14 0,05 - 0,14	0,14 - 0,20 0,14 - 0,20	470 - 490 440 - 460	0,05 - 0,14 0,05 - 0,14	0,14 - 0,20 0,14 - 0,20	540 - 560 505 - 525	0,05 - 0,14 0,05 - 0,14	0,14 - 0,20 0,14 - 0,20	325 - 345 305 - 325	0,17 - 0,23 0,17 - 0,23
540 - 560 505 - 525	0,05 - 0,14 0,05 - 0,14	0,14 - 0,20 0,14 - 0,20	325 - 345 305 - 325	0,05 - 0,14 0,05 - 0,14	0,14 - 0,20 0,14 - 0,20	470 - 490 440 - 460	0,05 - 0,14 0,05 - 0,14	0,14 - 0,20 0,14 - 0,20	540 - 560 505 - 525	0,05 - 0,14 0,05 - 0,14	0,14 - 0,20 0,14 - 0,20	325 - 345 305 - 325	0,17 - 0,23 0,17 - 0,23
460 - 480 480 - 500	0,05 - 0,14 0,05 - 0,14	0,14 - 0,20 0,14 - 0,20	280 - 300 290 - 310	0,05 - 0,14 0,05 - 0,14	0,14 - 0,20 0,14 - 0,20	400 - 420 415 - 435	0,05 - 0,14 0,05 - 0,14	0,14 - 0,20 0,14 - 0,20	460 - 480 480 - 500	0,05 - 0,14 0,05 - 0,14	0,14 - 0,20 0,14 - 0,20	280 - 300 290 - 310	0,17 - 0,23 0,17 - 0,23
460 - 480 420 - 440	0,05 - 0,14 0,05 - 0,14	0,14 - 0,20 0,14 - 0,20	280 - 300 250 - 270	0,05 - 0,14 0,05 - 0,14	0,14 - 0,20 0,14 - 0,20	400 - 420 365 - 385	0,05 - 0,14 0,05 - 0,14	0,14 - 0,20 0,14 - 0,20	460 - 480 420 - 440	0,05 - 0,14 0,05 - 0,14	0,14 - 0,20 0,14 - 0,20	280 - 300 250 - 270	0,17 - 0,23 0,17 - 0,23
540 - 560 505 - 525	0,05 - 0,14 0,05 - 0,14	0,14 - 0,20 0,14 - 0,20	325 - 345 305 - 325	0,05 - 0,14 0,05 - 0,14	0,14 - 0,20 0,14 - 0,20	470 - 490 440 - 460	0,05 - 0,14 0,05 - 0,14	0,14 - 0,20 0,14 - 0,20	540 - 560 505 - 525	0,05 - 0,14 0,05 - 0,14	0,14 - 0,20 0,14 - 0,20	325 - 345 305 - 325	0,17 - 0,23 0,17 - 0,23
525 - 545	0,05 - 0,14	0,14 - 0,20	315 - 335	0,05 - 0,14	0,14 - 0,20	455 - 475	0,05 - 0,14	0,14 - 0,20	525 - 545	0,05 - 0,14	0,14 - 0,20	315 - 335	0,17 - 0,23
290 - 310 315 - 335	0,05 - 0,14 0,05 - 0,14	0,14 - 0,20 0,14 - 0,20	170 - 190 190 - 210	0,05 - 0,14 0,05 - 0,14	0,14 - 0,20 0,14 - 0,20	250 - 270 275 - 295	0,05 - 0,14 0,05 - 0,14	0,14 - 0,20 0,14 - 0,20	290 - 310 315 - 335	0,05 - 0,14 0,05 - 0,14	0,14 - 0,20 0,14 - 0,20	170 - 190 190 - 210	0,17 - 0,23 0,17 - 0,23
295 - 315 315 - 335	0,05 - 0,14 0,05 - 0,14	0,14 - 0,20 0,14 - 0,20	175 - 195 190 - 210	0,05 - 0,14 0,05 - 0,14	0,14 - 0,20 0,14 - 0,20	255 - 275 275 - 295	0,05 - 0,14 0,05 - 0,14	0,14 - 0,20 0,14 - 0,20	295 - 315 315 - 335	0,05 - 0,14 0,05 - 0,14	0,14 - 0,20 0,14 - 0,20	175 - 195 190 - 210	0,17 - 0,23 0,17 - 0,23
290 - 310 295 - 315	0,05 - 0,14 0,05 - 0,14	0,14 - 0,20 0,14 - 0,20	170 - 190 175 - 195	0,05 - 0,14 0,05 - 0,14	0,14 - 0,20 0,14 - 0,20	250 - 270 255 - 275	0,05 - 0,14 0,05 - 0,14	0,14 - 0,20 0,14 - 0,20	290 - 310 295 - 315	0,05 - 0,14 0,05 - 0,14	0,14 - 0,20 0,14 - 0,20	170 - 190 175 - 195	0,17 - 0,23 0,17 - 0,23
35 - 55	0,01 - 0,04	0,04 - 0,07	20 - 40	0,01 - 0,04	0,04 - 0,07	30 - 50	0,01 - 0,04	0,04 - 0,07	35 - 55	0,01 - 0,04	0,04 - 0,07	20 - 40	0,05 - 0,10
15 - 35	0,01 - 0,03	0,03 - 0,06	5 - 15	0,01 - 0,03	0,03 - 0,06	10 - 30	0,01 - 0,03	0,03 - 0,06	15 - 35	0,01 - 0,03	0,03 - 0,06	5 - 15	0,04 - 0,09
20 - 40	0,01 - 0,03	0,03 - 0,06	5 - 15	0,01 - 0,03	0,03 - 0,06	15 - 35	0,01 - 0,03	0,03 - 0,06	20 - 40	0,01 - 0,03	0,03 - 0,06	5 - 15	0,04 - 0,09

The values given are empirical values that can be realised under optimal conditions. These values depend on the type of thread, thread depth, machine (rigidity, clamping etc.) and design of the tool. Depending on the requirements, these values must be adapted to the conditions.



Anwendungsempfehlungen und Schnittdaten

Reference of application and cutting data



sehr gut geeignet highly suitable
 gut geeignet well suitable
 geeignet suitable

Material	material	Festigkeit tensile [N/mm ²]	Härte hardness [HB]	Härte hardness [HRC]	Werkstoffbeispiel workpiece example	Werkstoffnr. workpiece material no.	GFM TiCN		GFM TiAlN	
							v _c [m/min]	f _z [mm]	v _c [m/min]	f _z [mm]
Stahlwerkstoffe/Steels	Magnetweicheisen, unlegierte Qualitätsstähle magnetic soft iron, non alloy high grade steels	≤ 400	≤ 120		RF60 St37-3G	1.1015 1.0116	105 - 125 105 - 125	0,10 - 0,16 0,10 - 0,16	120 - 140 120 - 140	0,10 - 0,16 0,10 - 0,16
	Automatenstähle, Allg. Baustähle free-cutting steels, general structural steels	≤ 600	≤ 200		9SMnPb28 St44-2	1.0718 1.0044	140 - 160 100 - 120	0,10 - 0,16 0,10 - 0,16	165 - 185 115 - 135	0,10 - 0,16 0,10 - 0,16
	Stahlguss, Automatenstähle, Legierte Stähle, Baustähle steel castings, free-cutting steels, alloy steels, general structural steels	≤ 850	≤ 250		GS-20Mn5N St70-2	1.1120 1.0070	140 - 160 115 - 135	0,10 - 0,16 0,10 - 0,16	165 - 185 135 - 155	0,10 - 0,16 0,10 - 0,16
	Einsatz-, Vergütungs-, Nitrier-, Kaltarbeitsstähle case hardening steels, quenched & tempered steels, nitriding steels, cold work steels	≤ 1100	≤ 350		16MnCr5 100Cr6	1.7131 1.2067	85 - 105 75 - 95	0,10 - 0,16 0,10 - 0,16	100 - 120 90 - 110	0,10 - 0,16 0,10 - 0,16
	Nitrier-, Kaltarbeits-, Warmarbeits-, Vergütungsstähle nitriding steels, cold work steels, hot working steels, quenched & tempered steels	≥ 1200	≥ 350		X155CrVMo12-1 42CrMo4	1.2379 1.7225	55 - 75 75 - 95	0,08 - 0,14 0,10 - 0,16	65 - 85 90 - 110	0,08 - 0,14 0,10 - 0,16
	gehärtete Stähle bis 44 HRC hardened steels ≤ 44 HRC	≤ 1400		≤ 44	59CrV4 X45CrNiMo4	1.2242 1.2767	40 - 60 40 - 60	0,08 - 0,14 0,08 - 0,14	50 - 70 50 - 70	0,08 - 0,14 0,08 - 0,14
	gehärtete Stähle bis 63 HRC hardened steels ≤ 63 HRC	≤ 2200		≤ 66	X165CrV12 200CrMn8	1.2201 1.2129				
	rostfreie Stähle stainless steels	≤ 850	≤ 250		X6CrAl13 X6CrTi17	1.4002 1.4510	45 - 65 40 - 60	0,08 - 0,14 0,08 - 0,14	55 - 75 50 - 70	0,08 - 0,14 0,08 - 0,14
	austenitische Stähle austenitic steels	≤ 850	≤ 250		X5CrNi18-10 X6CrNiTi18-10	1.4301 1.4541	40 - 60 30 - 50	0,08 - 0,14 0,08 - 0,14	50 - 70 35 - 55	0,08 - 0,14 0,08 - 0,14
	ferritisch-austenitische, ferritische oder martensitische Stähle ferritic-austenitic, ferritic or martensitic steels	≤ 1100	≤ 300		X45CrMoV15 X38Cr13	1.4116 1.4031	30 - 50 30 - 50	0,08 - 0,14 0,08 - 0,14	35 - 55 35 - 55	0,08 - 0,14 0,08 - 0,14
Guss/Dcast iron	Gusseisen mit Lamellengraphit grey cast iron	≤ 320	≤ 300		GG20 GG35	0.6020 0.6035	120 - 140 95 - 115	0,12 - 0,18 0,10 - 0,16	140 - 160 110 - 130	0,12 - 0,18 0,10 - 0,16
	Gusseisen mit Kugelgraphit nodular cast iron	≤ 800			GGG-40 GGG-80	0.7040 0.7080	90 - 110 85 - 105	0,12 - 0,18 0,10 - 0,16	105 - 125 100 - 120	0,12 - 0,18 0,10 - 0,16
	Temperguss malleable cast iron	≤ 420	≤ 230		GTW-35-04 GTW-S38-12	0.8035 0.8038	85 - 105 90 - 110	0,12 - 0,18 0,12 - 0,18	100 - 120 105 - 125	0,12 - 0,18 0,12 - 0,18
Titan/Titanium	Reintitan pure titanium	≤ 450			Ti Ti	3.7025 3.7035	35 - 55 30 - 50	0,10 - 0,16 0,10 - 0,16	40 - 60 35 - 55	0,10 - 0,16 0,10 - 0,16
	Titanlegierungen titanium alloys	≤ 900			Ti-6Al-4V Ti-3Al	3.7164 3.7065	20 - 40 20 - 40	0,10 - 0,16 0,10 - 0,16	25 - 45 25 - 45	0,10 - 0,16 0,10 - 0,16
	Titanlegierungen titanium alloys	≤ 1200			TiAl4Mo4Sn2Si0.5		20 - 40	0,10 - 0,16	25 - 45	0,10 - 0,16
Magnesium	Magnesium-Knetlegierungen wrought magnesium alloys	≤ 310			MgMn2 MgAl8Zn	3.5200 3.5812	470 - 490 440 - 460	0,17 - 0,23 0,17 - 0,23	540 - 560 505 - 525	0,17 - 0,23 0,17 - 0,23
	Magnesium-Gusslegierungen cast magnesium alloys	≤ 170			G-MgAl8Zn1 G-MgAl6	3.5912 3.5662	470 - 490 440 - 460	0,17 - 0,23 0,17 - 0,23	540 - 560 505 - 525	0,17 - 0,23 0,17 - 0,23
Aluminium	Aluminium unlegiert aluminium	≤ 140	≤ 50		Al99 Al99,8	3.0205 3.0285	400 - 420 415 - 435	0,17 - 0,23 0,17 - 0,23	460 - 480 480 - 500	0,17 - 0,23 0,17 - 0,23
	Aluminium-Knetlegierungen wrought aluminium alloys	≤ 520	≤ 140		AlCuMg2 AlZnMgCu1,5	3.1355 3.4365	400 - 420 365 - 385	0,17 - 0,23 0,17 - 0,23	460 - 480 420 - 440	0,17 - 0,23 0,17 - 0,23
	Alu-Gusslegierungen < 12% Si aluminium alloy castings < 12% Si	≤ 210	≤ 110		G-AlSi10Mg G-AlMg5Si	3.2381 3.3261	470 - 490 440 - 460	0,17 - 0,23 0,17 - 0,23	540 - 560 505 - 525	0,17 - 0,23 0,17 - 0,23
	Alu-Gusslegierungen > 12% Si aluminium alloy castings > 12% Si	≤ 300	≤ 90		G-AlSi12	3.2581	455 - 475	0,17 - 0,23	525 - 545	0,17 - 0,23
Kupfer/Copper	Kupfer-Zinn-Legierungen copper-zinc alloys (brass)	≤ 470			CuZn40 CuZn38Pb1,5	2.0360 2.0371	250 - 270 275 - 295	0,17 - 0,23 0,17 - 0,23	290 - 310 315 - 335	0,17 - 0,23 0,17 - 0,23
	Kupfer-Zinn-Legierungen copper-tin alloys (bronze)	≤ 700			CuSn6 CuSn8	2.1020 2.1030	255 - 275 275 - 295	0,17 - 0,23 0,17 - 0,23	295 - 315 315 - 335	0,17 - 0,23 0,17 - 0,23
	Kupfer-Aluminium-Legierungen copper-aluminium alloys	≤ 600			CuAl8 CuAl9Mn2	2.0920 2.0960	250 - 270 255 - 275	0,17 - 0,23 0,17 - 0,23	290 - 310 295 - 315	0,17 - 0,23 0,17 - 0,23
Nickel	warmfeste Nickellegierungen heat resistant nickel alloys	≤ 850			NiCu30Fe	2.4360	30 - 50	0,05 - 0,10	35 - 55	0,05 - 0,10
	hochwarmfeste Nickellegierungen highly heat resistant nickel alloys	≤ 1400			Inconel® 718	2.4668	10 - 30	0,04 - 0,09	15 - 35	0,04 - 0,09
	hochwarmfeste Nickellegierungen highly heat resistant nickel alloys	≤ 1400			Haynes® 25		15 - 35	0,04 - 0,09	20 - 40	0,04 - 0,09

Die angegebenen Werte sind Erfahrungswerte, die bei optimalen Bedingungen realisierbar sind. Diese Werte sind abhängig von Gewindeart, Gewindetiefe, Maschine (Steifigkeit, Aufspannung etc.) und Ausführung des Werkzeuges. Je nach Bedarf müssen diese Werte den Gegebenheiten angepasst werden.



GF SHARK			GFM SHARK		GFH			GFT-H		GFE	
v _c	f _z [mm]		v _c	f _z [mm]	v _c	f _z [mm]		v _c	f _z [mm]	v _c	f _z [mm]
	[m/min]	d _s ≤ 7 mm				d > 7 mm	[m/min]				
105 - 125 105 - 125	0,03 - 0,09 0,03 - 0,09	0,09 - 0,20 0,09 - 0,20	105 - 125 105 - 125	0,13 - 0,20 0,13 - 0,20						70 - 90 70 - 90	0,005 - 0,06 0,005 - 0,06
140 - 160 100 - 120	0,03 - 0,09 0,03 - 0,09	0,09 - 0,20 0,09 - 0,20	140 - 160 100 - 120	0,13 - 0,20 0,13 - 0,20						95 - 115 70 - 80	0,005 - 0,06 0,005 - 0,06
140 - 160 115 - 135	0,03 - 0,09 0,03 - 0,09	0,09 - 0,20 0,09 - 0,20	140 - 160 115 - 135	0,13 - 0,20 0,13 - 0,20						95 - 115 75 - 95	0,005 - 0,06 0,005 - 0,06
85 - 105 75 - 95	0,03 - 0,09 0,03 - 0,09	0,09 - 0,20 0,09 - 0,20	85 - 105 75 - 95	0,13 - 0,20 0,13 - 0,20						55 - 75 50 - 70	0,005 - 0,06 0,005 - 0,06
55 - 75 75 - 95	0,02 - 0,08 0,03 - 0,09	0,08 - 0,15 0,09 - 0,20	55 - 75 75 - 95	0,10 - 0,18 0,13 - 0,20						35 - 55 50 - 70	0,005 - 0,05 0,005 - 0,06
40 - 60 40 - 60	0,02 - 0,08 0,02 - 0,08	0,08 - 0,15 0,08 - 0,15	40 - 60 40 - 60	0,10 - 0,18 0,10 - 0,18						25 - 45 25 - 45	0,005 - 0,05 0,005 - 0,05
					35 - 55 35 - 55	0,01 - 0,03 0,01 - 0,03	0,02 - 0,06 0,02 - 0,06	35 - 55 35 - 55	0,03 - 0,13 0,03 - 0,13		
45 - 65 40 - 60	0,02 - 0,08 0,02 - 0,08	0,08 - 0,15 0,08 - 0,15	45 - 65 40 - 60	0,10 - 0,18 0,10 - 0,18						30 - 50 25 - 45	0,005 - 0,05 0,005 - 0,05
40 - 60 30 - 50	0,02 - 0,08 0,02 - 0,08	0,08 - 0,15 0,08 - 0,15	40 - 60 30 - 50	0,10 - 0,18 0,10 - 0,18						25 - 45 20 - 40	0,005 - 0,05 0,005 - 0,05
30 - 50 30 - 50	0,02 - 0,08 0,02 - 0,08	0,08 - 0,15 0,08 - 0,15	30 - 50 30 - 50	0,10 - 0,18 0,10 - 0,18						20 - 40 20 - 40	0,005 - 0,05 0,005 - 0,05
120 - 140 95 - 115	0,04 - 0,11 0,03 - 0,09	0,11 - 0,23 0,09 - 0,20	120 - 140 95 - 115	0,15 - 0,23 0,13 - 0,20						80 - 100 65 - 85	0,005 - 0,07 0,005 - 0,06
90 - 110 85 - 105	0,04 - 0,11 0,03 - 0,09	0,11 - 0,23 0,09 - 0,20	90 - 110 85 - 105	0,15 - 0,23 0,13 - 0,20						60 - 80 55 - 75	0,005 - 0,07 0,005 - 0,06
85 - 105 90 - 110	0,04 - 0,11 0,04 - 0,11	0,11 - 0,23 0,11 - 0,23	85 - 105 90 - 110	0,15 - 0,23 0,15 - 0,23						55 - 75 60 - 80	0,005 - 0,07 0,005 - 0,07
35 - 55 30 - 50	0,03 - 0,08 0,03 - 0,08	0,07 - 0,15 0,07 - 0,15	35 - 55 30 - 50	0,13 - 0,20 0,13 - 0,20						20 - 40 15 - 35	0,005 - 0,05 0,005 - 0,05
20 - 40 20 - 40	0,03 - 0,08 0,03 - 0,08	0,07 - 0,15 0,07 - 0,15	20 - 40 20 - 40	0,13 - 0,20 0,13 - 0,20						10 - 30 10 - 30	0,005 - 0,05 0,005 - 0,05
20 - 40	0,03 - 0,08	0,07 - 0,15	20 - 40	0,13 - 0,20						10 - 30	0,005 - 0,05
470 - 490 440 - 460	0,07 - 0,21 0,07 - 0,21	0,21 - 0,30 0,21 - 0,30	470 - 490 440 - 460	0,21 - 0,29 0,21 - 0,29						325 - 345 305 - 325	0,02 - 0,14 0,02 - 0,14
470 - 490 440 - 460	0,07 - 0,21 0,07 - 0,21	0,21 - 0,30 0,21 - 0,30	470 - 490 440 - 460	0,21 - 0,29 0,21 - 0,29						325 - 345 305 - 325	0,02 - 0,14 0,02 - 0,14
400 - 420 415 - 435	0,07 - 0,21 0,07 - 0,21	0,21 - 0,30 0,21 - 0,30	400 - 420 415 - 435	0,21 - 0,29 0,21 - 0,29						280 - 300 290 - 310	0,02 - 0,14 0,02 - 0,14
400 - 420 365 - 385	0,07 - 0,21 0,07 - 0,21	0,21 - 0,30 0,21 - 0,30	400 - 420 365 - 385	0,21 - 0,29 0,21 - 0,29						280 - 300 250 - 270	0,02 - 0,14 0,02 - 0,14
470 - 490 440 - 460	0,07 - 0,21 0,07 - 0,21	0,21 - 0,30 0,21 - 0,30	470 - 490 440 - 460	0,21 - 0,29 0,21 - 0,29						325 - 345 305 - 325	0,02 - 0,14 0,02 - 0,14
455 - 475	0,07 - 0,21	0,21 - 0,30	455 - 475	0,21 - 0,29						315 - 335	0,02 - 0,14
250 - 270 275 - 295	0,07 - 0,21 0,07 - 0,21	0,21 - 0,30 0,21 - 0,30	250 - 270 275 - 295	0,21 - 0,29 0,21 - 0,29						170 - 190 190 - 210	0,02 - 0,14 0,02 - 0,14
255 - 275 275 - 295	0,07 - 0,21 0,07 - 0,21	0,21 - 0,30 0,21 - 0,30	255 - 275 275 - 295	0,21 - 0,29 0,21 - 0,29						175 - 195 190 - 210	0,02 - 0,14 0,02 - 0,14
250 - 270 255 - 275	0,07 - 0,21 0,07 - 0,21	0,21 - 0,30 0,21 - 0,30	250 - 270 255 - 275	0,21 - 0,29 0,21 - 0,29						170 - 190 175 - 195	0,02 - 0,14 0,02 - 0,14
30 - 50	0,02 - 0,06	0,06 - 0,10	30 - 50	0,06 - 0,12						20 - 40	0,005 - 0,04
10 - 30	0,02 - 0,05	0,04 - 0,09	10 - 30	0,05 - 0,11						5 - 15	0,005 - 0,03
15 - 35	0,02 - 0,05	0,04 - 0,09	15 - 35	0,05 - 0,11						5 - 15	0,005 - 0,03

The values given are empirical values that can be realised under optimal conditions. These values depend on the type of thread, thread depth, machine (rigidity, clamping etc.) and design of the tool. Depending on the requirements, these values must be adapted to the conditions.



Anwendungsempfehlungen und Schnittdaten

Reference of application and cutting data



sehr gut geeignet highly suitable
 gut geeignet well suitable
 geeignet suitable

Material	material	Festigkeit tensile [N/mm ²]	Härte hardness [HB]	Härte hardness [HRC]	Werkstoffbeispiel workpiece example	Werkstoffnr. material no.	GFE TiCN		GFT SHARK		
							v _c [m/min]	f _z [mm]	v _c [m/min]	f _z [mm]	
										d _s ≤ 7 mm	d > 7 mm
Stahlwerkstoffe/Steels	Magnetweicheisen, unlegierte Qualitätsstähle magnetic soft iron, non alloy high grade steels	≤ 400	≤ 120		RF60 St37-3G	1.1015 1.0116	105 - 125 105 - 125	0,005 - 0,06 0,005 - 0,06	105 - 125 105 - 125	0,03 - 0,09 0,03 - 0,09	0,09 - 0,20 0,09 - 0,20
	Automatenstähle, Allg. Baustähle free-cutting steels, general structural steels	≤ 600	≤ 200		9SMnPb28 St44-2	1.0718 1.0044	140 - 160 100 - 120	0,005 - 0,06 0,005 - 0,06	140 - 160 100 - 120	0,03 - 0,09 0,03 - 0,09	0,09 - 0,20 0,09 - 0,20
	Stahlguss, Automatenstähle, Legierte Stähle, Baustähle steel castings, free-cutting steels, alloy steels, general structural steels	≤ 850	≤ 250		GS-20Mn5N St70-2	1.1120 1.0070	140 - 160 115 - 135	0,005 - 0,06 0,005 - 0,06	140 - 160 115 - 135	0,03 - 0,09 0,03 - 0,09	0,09 - 0,20 0,09 - 0,20
	Einsatz-, Vergütungs-, Nitrier-, Kaltarbeitsstähle case hardening steels, quenched & tempered steels, nitriding steels, cold work steels	≤ 1100	≤ 350		16MnCr5 100Cr6	1.7131 1.2067	85 - 105 75 - 95	0,005 - 0,06 0,005 - 0,06	85 - 105 75 - 95	0,03 - 0,09 0,03 - 0,09	0,09 - 0,20 0,09 - 0,20
	Nitrier-, Kaltarbeits-, Warmarbeits-, Vergütungsstähle nitriding steels, cold work steels, hot working steels, quenched & tempered steels	≥ 1200	≥ 350		X155CrVMo12-1 42CrMo4	1.2379 1.7225	55 - 75 75 - 95	0,005 - 0,05 0,005 - 0,06	55 - 75 75 - 95	0,02 - 0,08 0,03 - 0,09	0,08 - 0,15 0,09 - 0,20
	gehärtete Stähle bis 44 HRC hardened steels ≤ 44 HRC	≤ 1400		≤ 44	59CrV4 X45CrNiMo4	1.2242 1.2767	40 - 60 40 - 60	0,005 - 0,05 0,005 - 0,05	40 - 60 40 - 60	0,02 - 0,08 0,02 - 0,08	0,08 - 0,15 0,08 - 0,15
	gehärtete Stähle bis 63 HRC hardened steels ≤ 63 HRC	≤ 2200		≤ 66	X165CrV12 200CrMn8	1.2201 1.2129					
	rostfreie Stähle stainless steels	≤ 850	≤ 250		X6CrAl13 X6CrTi17	1.4002 1.4510	45 - 65 40 - 60	0,005 - 0,05 0,005 - 0,05	45 - 65 40 - 60	0,02 - 0,08 0,02 - 0,08	0,08 - 0,15 0,08 - 0,15
	austenitische Stähle austenitic steels	≤ 850	≤ 250		X5CrNi18-10 X6CrNiTi18-10	1.4301 1.4541	40 - 60 30 - 50	0,005 - 0,05 0,005 - 0,05	40 - 60 30 - 50	0,02 - 0,08 0,02 - 0,08	0,08 - 0,15 0,08 - 0,15
	ferritisch-austenitische, ferritische oder martensitische Stähle ferritic-austenitic, ferritic or martensitic steels	≤ 1100	≤ 300		X45CrMoV15 X38Cr13	1.4116 1.4031	30 - 50 30 - 50	0,005 - 0,05 0,005 - 0,05	30 - 50 30 - 50	0,02 - 0,08 0,02 - 0,08	0,08 - 0,15 0,08 - 0,15
Guss/Gcast iron	Gusseisen mit Lamellengraphit grey cast iron	≤ 320	≤ 300		GG20 GG35	0.6020 0.6035	120 - 140 95 - 115	0,005 - 0,07 0,005 - 0,06	120 - 140 95 - 115	0,04 - 0,11 0,03 - 0,09	0,11 - 0,23 0,09 - 0,20
	Gusseisen mit Kugelgraphit nodular cast iron	≤ 800			GGG-40 GGG-80	0.7040 0.7080	90 - 110 85 - 105	0,005 - 0,07 0,005 - 0,06	90 - 110 85 - 105	0,04 - 0,11 0,03 - 0,09	0,11 - 0,23 0,09 - 0,20
	Temperguss malleable cast iron	≤ 420	≤ 230		GTW-35-04 GTW-S38-12	0.8035 0.8038	85 - 105 90 - 110	0,005 - 0,07 0,005 - 0,07	85 - 105 90 - 110	0,04 - 0,11 0,04 - 0,11	0,11 - 0,23 0,11 - 0,23
Titan/Titanium	Reintitan pure titanium	≤ 450			Ti Ti	3.7025 3.7035	35 - 55 30 - 50	0,005 - 0,05 0,005 - 0,05	35 - 55 30 - 50	0,03 - 0,08 0,03 - 0,08	0,07 - 0,15 0,07 - 0,15
	Titanlegierungen titanium alloys	≤ 900			Ti-6Al-4V Ti-3Al	3.7164 3.7065	20 - 40 20 - 40	0,005 - 0,05 0,005 - 0,05	20 - 40 20 - 40	0,03 - 0,08 0,03 - 0,08	0,07 - 0,15 0,07 - 0,15
	Titanlegierungen titanium alloys	≤ 1200			TiAl4Mo4Sn2Si0.5		20 - 40	0,005 - 0,05	20 - 40	0,03 - 0,08	0,07 - 0,15
Magnesium	Magnesium-Knetlegierungen wrought magnesium alloys	≤ 310			MgMn2 MgAl8Zn	3.5200 3.5812	470 - 490 440 - 460	0,02 - 0,14 0,02 - 0,14	470 - 490 440 - 460	0,07 - 0,21 0,07 - 0,21	0,21 - 0,30 0,21 - 0,30
	Magnesium-Gusslegierungen cast magnesium alloys	≤ 170			G-MgAl8Zn1 G-MgAl6	3.5912 3.5662	470 - 490 440 - 460	0,02 - 0,14 0,02 - 0,14	470 - 490 440 - 460	0,07 - 0,21 0,07 - 0,21	0,21 - 0,30 0,21 - 0,30
Aluminium	Aluminium unlegiert aluminium	≤ 140	≤ 50		Al99 Al99,8	3.0205 3.0285	400 - 420 415 - 435	0,02 - 0,14 0,02 - 0,14	400 - 420 415 - 435	0,07 - 0,21 0,07 - 0,21	0,21 - 0,30 0,21 - 0,30
	Aluminium-Knetlegierungen wrought aluminium alloys	≤ 520	≤ 140		AlCuMg2 AlZnMgCu1,5	3.1355 3.4365	400 - 420 365 - 385	0,02 - 0,14 0,02 - 0,14	400 - 420 365 - 385	0,07 - 0,21 0,07 - 0,21	0,21 - 0,30 0,21 - 0,30
	Alu-Gusslegierungen < 12% Si aluminium alloy castings < 12% Si	≤ 210	≤ 110		G-ALSi10Mg G-ALMg5Si	3.2381 3.3261	470 - 490 440 - 460	0,02 - 0,14 0,02 - 0,14	470 - 490 440 - 460	0,07 - 0,21 0,07 - 0,21	0,21 - 0,30 0,21 - 0,30
	Alu-Gusslegierungen > 12% Si aluminium alloy castings > 12% Si	≤ 300	≤ 90		G-ALSi12	3.2581	455 - 475	0,02 - 0,14	455 - 475	0,07 - 0,21	0,21 - 0,30
Kupfer/Copper	Kupfer-Zink-Legierungen copper-zinc alloys (brass)	≤ 470			CuZn40 CuZn38Pb1,5	2.0360 2.0371	250 - 270 275 - 295	0,02 - 0,14 0,02 - 0,14	250 - 270 275 - 295	0,07 - 0,21 0,07 - 0,21	0,21 - 0,30 0,21 - 0,30
	Kupfer-Zinn-Legierungen copper-tin alloys (bronze)	≤ 700			CuSn6 CuSn8	2.1020 2.1030	255 - 275 275 - 295	0,02 - 0,14 0,02 - 0,14	255 - 275 275 - 295	0,07 - 0,21 0,07 - 0,21	0,21 - 0,30 0,21 - 0,30
	Kupfer-Aluminium-Legierungen copper-aluminium alloys	≤ 600			CuAl8 CuAl9Mn2	2.0920 2.0960	250 - 270 255 - 275	0,02 - 0,14 0,02 - 0,14	250 - 270 255 - 275	0,07 - 0,21 0,07 - 0,21	0,21 - 0,30 0,21 - 0,30
Nickel	warmfeste Nickellegierungen heat resistant nickel alloys	≤ 850			NiCu30Fe	2.4360	30 - 50	0,005 - 0,04	30 - 50	0,02 - 0,06	0,06 - 0,10
	hochwarmfeste Nickellegierungen highly heat resistant nickel alloys	≤ 1400			Inconel® 718	2.4668	10 - 30	0,005 - 0,03	10 - 30	0,02 - 0,05	0,04 - 0,09
	hochwarmfeste Nickellegierungen highly heat resistant nickel alloys	≤ 1400			Haynes® 25		15 - 35	0,005 - 0,03	15 - 35	0,02 - 0,05	0,04 - 0,09

Die angegebenen Werte sind Erfahrungswerte, die bei optimalen Bedingungen realisierbar sind. Diese Werte sind abhängig von Gewindeart, Gewindetiefe, Maschine (Steifigkeit, Aufspannung etc.) und Ausführung des Werkzeuges. Je nach Bedarf müssen diese Werte den Gegebenheiten angepasst werden. Bei langspanenden Werkstoffen kann ein ein- oder mehrfaches Entspannen notwendig sein!

Anwendungsempfehlungen und Schnittdaten

Reference of application and cutting data



sehr gut geeignet highly suitable
 gut geeignet well suitable
 geeignet suitable

Material	material	Festigkeit tensile [N/mm ²]	Härte hardness [HB]	Härte hardness [HRC]	Werkstoffbeispiel workpiece example	Werkstoffnr. workpiece material no.	BGF3				
							v _c [m/min]	f _s [mm/U]		f _z [mm]	
								d ≤ 7 mm	d > 7 mm	d ≤ 7 mm	d > 7 mm
Stahlwerkstoffe/Steels	Magnetweicheisen, unlegierte Qualitätsstähle magnetic soft iron, non alloy high grade steels	≤ 400	≤ 120		RFe60 St37-3G	1.1015 1.0116					
	Automatenstähle, Allg. Baustähle free-cutting steels, general structural steels	≤ 600	≤ 200		9SMnPb28 St44-2	1.0718 1.0044					
	Stahlguss, Automatenstähle, Legierte Stähle, Baustähle steel castings, free-cutting steels, alloy steels, general structural steels	≤ 850	≤ 250		GS-20Mn5N St70-2	1.1120 1.0070					
	Einsatz-, Vergütungs-, Nitrier-, Kaltarbeitsstähle case hardening steels, quenched & tempered steels, nitriding steels, cold work steels	≤ 1100	≤ 350		16MnCr5 100Cr6	1.7131 1.2067					
	Nitrier-, Kaltarbeits-, Warmarbeits-, Vergütungsstähle nitriding steels, cold work steels, hot working steels, quenched & tempered steels	≥ 1200	≥ 350		X155CrVMo12-1 42CrMo4	1.2379 1.7225					
	gehärtete Stähle bis 44 HRC hardened steels ≤ 44 HRC	≤ 1400		≤ 44	59CrV4 X45CrNiMo4	1.2242 1.2767					
	gehärtete Stähle bis 63 HRC hardened steels ≤ 63 HRC	≤ 2200		≤ 66	X165CrV12 200CrMn8	1.2201 1.2129					
	rostfreie Stähle stainless steels	≤ 850	≤ 250		X6CrAl13 X6CrTi17	1.4002 1.4510					
	austenitische Stähle austenitic steels	≤ 850	≤ 250		X5CrNi18-10 X6CrNiTi18-10	1.4301 1.4541					
	ferritisch-austenitische, ferritische oder martensitische Stähle ferritic-austenitic, ferritic or martensitic steels	≤ 1100	≤ 300		X45CrMoV15 X38Cr13	1.4116 1.4031					
Guss/Dcast iron	Gusseisen mit Lamellengraphit grey cast iron	≤ 320	≤ 300		GG20 GG35	0.6020 0.6035	80 - 100 65 - 85	0,08 - 0,30 0,08 - 0,30	0,20 - 0,60 0,20 - 0,60	0,03 - 0,07 0,02 - 0,06	0,07 - 0,15 0,06 - 0,13
	Gusseisen mit Kugelgraphit nodular cast iron	≤ 800			GGG-40 GGG-80	0.7040 0.7080	60 - 80 55 - 75	0,08 - 0,30 0,08 - 0,30	0,20 - 0,50 0,20 - 0,50	0,03 - 0,07 0,02 - 0,06	0,07 - 0,15 0,06 - 0,13
	Temperguss malleable cast iron	≤ 420	≤ 230		GTW-35-04 GTW-S38-12	0.8035 0.8038	55 - 75 60 - 80	0,08 - 0,30 0,08 - 0,30	0,20 - 0,50 0,20 - 0,50	0,03 - 0,07 0,03 - 0,07	0,07 - 0,15 0,07 - 0,15
Titan/Titanium	Reintitan pure titanium	≤ 450			Ti Ti	3.7025 3.7035					
	Titanlegierungen titanium alloys	≤ 900			Ti-6Al-4V Ti-3Al	3.7164 3.7065					
	Titanlegierungen titanium alloys	≤ 1200			TiAl4Mo4Sn2Si0.5						
Magnesium	Magnesium-Knetlegierungen wrought magnesium alloys	≤ 310			MgMn2 MgAl8Zn	3.5200 3.5812	325 - 345 305 - 325	0,08 - 0,30 0,08 - 0,30	0,20 - 0,60 0,20 - 0,60	0,05 - 0,14 0,05 - 0,14	0,14 - 0,20 0,14 - 0,20
	Magnesium-Gusslegierungen cast magnesium alloys	≤ 170			G-MgAl8Zn1 G-MgAl6	3.5912 3.5662	325 - 345 305 - 325	0,08 - 0,30 0,08 - 0,30	0,20 - 0,60 0,20 - 0,60	0,05 - 0,14 0,05 - 0,14	0,14 - 0,20 0,14 - 0,20
Aluminium	Aluminium unlegiert aluminium	≤ 140	≤ 50		Al99 Al99,8	3.0205 3.0285	280 - 300 290 - 310	0,08 - 0,30 0,08 - 0,30	0,20 - 0,60 0,20 - 0,60	0,05 - 0,14 0,05 - 0,14	0,14 - 0,20 0,14 - 0,20
	Aluminium-Knetlegierungen wrought aluminium alloys	≤ 520	≤ 140		AlCuMg2 AlZnMgCu1,5	3.1355 3.4365	280 - 300 250 - 270	0,08 - 0,30 0,08 - 0,30	0,20 - 0,60 0,20 - 0,60	0,05 - 0,14 0,05 - 0,14	0,14 - 0,20 0,14 - 0,20
	Alu-Gusslegierungen < 12% Si aluminium alloy castings < 12% Si	≤ 210	≤ 110		G-ALSi10Mg G-ALMg5Si	3.2381 3.3261	325 - 345 305 - 325	0,08 - 0,30 0,08 - 0,30	0,20 - 0,60 0,20 - 0,60	0,05 - 0,14 0,05 - 0,14	0,14 - 0,20 0,14 - 0,20
	Alu-Gusslegierungen > 12% Si aluminium alloy castings > 12% Si	≤ 300	≤ 90		G-ALSi12	3.2581	315 - 335	0,08 - 0,30	0,20 - 0,60	0,05 - 0,14	0,14 - 0,20
Kupfer/Copper	Kupfer-Zinn-Legierungen copper-zinc alloys (brass)	≤ 470			CuZn40 CuZn38Pb1,5	2.0360 2.0371	170 - 190 190 - 210	0,06 - 0,25 0,06 - 0,25	0,15 - 0,40 0,15 - 0,40	0,05 - 0,14 0,05 - 0,14	0,14 - 0,20 0,14 - 0,20
	Kupfer-Zinn-Legierungen copper-tin alloys (bronze)	≤ 700			CuSn6 CuSn8	2.1020 2.1030	175 - 195 190 - 210	0,06 - 0,25 0,06 - 0,25	0,12 - 0,30 0,12 - 0,30	0,05 - 0,14 0,05 - 0,14	0,14 - 0,20 0,14 - 0,20
	Kupfer-Aluminium-Legierungen copper-aluminium alloys	≤ 600			CuAl8 CuAl9Mn2	2.0920 2.0960	170 - 190 175 - 195	0,06 - 0,25 0,06 - 0,25	0,12 - 0,30 0,12 - 0,30	0,05 - 0,14 0,05 - 0,14	0,14 - 0,20 0,14 - 0,20
Nickel	warmfeste Nickellegierungen heat resistant nickel alloys	≤ 850			NiCu30Fe	2.4360					
	hochwarmfeste Nickellegierungen highly heat resistant nickel alloys	≤ 1400			Inconel® 718	2.4668					
	hochwarmfeste Nickellegierungen highly heat resistant nickel alloys	≤ 1400			Haynes® 25						

Die angegebenen Werte sind Erfahrungswerte, die bei optimalen Bedingungen realisierbar sind. Diese Werte sind abhängig von Gewindeart, Gewindetiefe, Maschine (Steifigkeit, Aufspannung etc.) und Ausführung des Werkzeuges. Je nach Bedarf müssen diese Werte den Gegebenheiten angepasst werden. Bei langspanenden Werkstoffen kann ein ein- oder mehrfaches Entspannen notwendig sein!

Anwendungsempfehlungen und Schnittdaten

Reference of application and cutting data



sehr gut geeignet highly suitable
 gut geeignet well suitable
 geeignet suitable

Material	material	Festigkeit tensile [N/mm ²]	Härte hardness [HB]	Härte hardness [HRC]	Werkstoffbeispiel workpiece example	Werkstoffnr. workpiece material no.	BGFS									
							v _c [m/min]	f _z [mm]								
								d ≤ 2	d ≤ 3	d ≤ 4	d ≤ 5	d ≤ 6	d ≤ 8	d ≤ 10	d ≤ 12	
Stahlwerkstoffe/Steels	Magnetweicheisen, unlegierte Qualitätsstähle magnetic soft iron, non alloy high grade steels	≤ 400	≤ 120		RF60 St37-3G	1.1015 1.0116	85 85	0,011 0,011	0,015 0,015	0,018 0,018	0,023 0,023	0,031 0,031	0,038 0,038	0,045 0,045	0,050 0,050	
	Automatenstähle, Allg. Baustähle free-cutting steels, general structural steels	≤ 600	≤ 200		9SMnPb28 St44-2	1.0718 1.0044	75 80	0,011 0,011	0,014 0,015	0,017 0,018	0,022 0,023	0,030 0,031	0,037 0,038	0,043 0,045	0,048 0,050	
	Stahlguss, Automatenstähle, Legierte Stähle, Baustähle steel castings, free-cutting steels, alloy steels, general structural steels	≤ 850	≤ 250		GS-20Mn5N St70-2	1.1120 1.0070	75 65	0,011 0,011	0,014 0,014	0,017 0,017	0,022 0,022	0,030 0,030	0,037 0,037	0,043 0,043	0,048 0,048	
	Einsatz-, Vergütungs-, Nitrier-, Kaltarbeitsstähle case hardening steels, quenched & tempered steels, nitriding steels, cold work steels	≤ 1100	≤ 350		16MnCr5 100Cr6	1.7131 1.2067	70 70	0,010 0,010	0,014 0,014	0,016 0,016	0,021 0,021	0,028 0,028	0,035 0,035	0,041 0,041	0,046 0,046	
	Nitrier-, Kaltarbeits-, Warmarbeits-, Vergütungsstähle nitriding steels, cold work steels, hot working steels, quenched & tempered steels	≥ 1200	≥ 350		X155CrVMo12-1 42CrMo4	1.2379 1.7225	60 70	0,010 0,010	0,014 0,014	0,016 0,016	0,021 0,021	0,028 0,028	0,035 0,035	0,041 0,041	0,046 0,046	
	gehärtete Stähle bis 44 HRC hardened steels ≤ 44 HRC	≤ 1400		≤ 44	59CrV4 X45CrNiMo4	1.2242 1.2767	55 50	0,010 0,010	0,014 0,013	0,016 0,016	0,021 0,020	0,028 0,027	0,035 0,033	0,041 0,039	0,046 0,044	
	gehärtete Stähle bis 63 HRC hardened steels ≤ 63 HRC	≤ 2200		≤ 66	X165CrV12 200CrMn8	1.2201 1.2129	40 30	0,009 0,008	0,012 0,011	0,014 0,013	0,018 0,016	0,024 0,022	0,029 0,027	0,035 0,032	0,039 0,036	
	rostfreie Stähle stainless steels	≤ 850	≤ 250		X6CrAl13 X6CrTi17	1.4002 1.4510	45 40	0,009 0,009	0,012 0,012	0,015 0,015	0,019 0,019	0,026 0,026	0,031 0,031	0,037 0,037	0,041 0,041	
	austenitische Stähle austenitic steels	≤ 850	≤ 250		X5CrNi18-10 X6CrNiTi18-10	1.4301 1.4541	40 35	0,009 0,009	0,012 0,012	0,015 0,015	0,019 0,019	0,026 0,026	0,031 0,031	0,037 0,037	0,041 0,041	
	ferritisch-austenitische, ferritische oder martensitische Stähle ferritic-austenitic, ferritic or martensitic steels	≤ 1100	≤ 300		X45CrMoV15 X38Cr13	1.4116 1.4031	40 30	0,009 0,008	0,012 0,011	0,014 0,013	0,018 0,016	0,024 0,022	0,029 0,027	0,035 0,032	0,039 0,036	
Guss/Gcast iron	Gusseisen mit Lamellengraphit grey cast iron	≤ 320	≤ 300		GG20 GG35	0.6020 0.6035	85 85	0,011 0,011	0,015 0,015	0,018 0,018	0,023 0,023	0,031 0,031	0,038 0,038	0,045 0,045	0,050 0,050	
	Gusseisen mit Kugelgraphit nodular cast iron	≤ 800			GGG-40 GGG-80	0.7040 0.7080	80 80	0,011 0,011	0,015 0,015	0,018 0,018	0,023 0,023	0,031 0,031	0,038 0,038	0,045 0,045	0,050 0,050	
	Temperguss malleable cast iron	≤ 420	≤ 230		GTW-35-04 GTW-S38-12	0.8035 0.8038	75 75	0,011 0,011	0,015 0,015	0,018 0,018	0,023 0,023	0,031 0,031	0,038 0,038	0,045 0,045	0,050 0,050	
Titan/Titanium	Reintitan pure titanium	≤ 450			Ti Ti	3.7025 3.7035	50 50	0,009 0,009	0,012 0,012	0,015 0,015	0,019 0,019	0,026 0,026	0,031 0,031	0,037 0,037	0,041 0,041	
	Titanlegierungen titanium alloys	≤ 900			Ti-6Al-4V Ti-3Al	3.7164 3.7065	45 45	0,009 0,009	0,012 0,012	0,015 0,015	0,019 0,019	0,026 0,026	0,031 0,031	0,037 0,037	0,041 0,041	
	Titanlegierungen titanium alloys	≤ 1200			TiAl4Mo4Sn2Si0.5		40	0,009	0,012	0,015	0,019	0,026	0,031	0,037	0,041	
Magnesium	Magnesium-Knetlegierungen wrought magnesium alloys	≤ 310			MgMn2 MgAl8Zn	3.5200 3.5812	85 85	0,011 0,011	0,015 0,015	0,018 0,018	0,023 0,023	0,031 0,031	0,038 0,038	0,045 0,045	0,050 0,050	
	Magnesium-Gusslegierungen cast magnesium alloys	≤ 170			G-MgAl8Zn1 G-MgAl6	3.5912 3.5662	85 85	0,011 0,011	0,015 0,015	0,018 0,018	0,023 0,023	0,031 0,031	0,038 0,038	0,045 0,045	0,050 0,050	
Aluminium	Aluminium unlegiert aluminium	≤ 140	≤ 50		Al99 Al99,8	3.0205 3.0285										
	Aluminium-Knetlegierungen wrought aluminium alloys	≤ 520	≤ 140		AlCuMg2 AlZnMgCu1,5	3.1355 3.4365										
	Alu-Gusslegierungen < 12% Si aluminium alloy castings < 12% Si	≤ 210	≤ 110		G-ALSi10Mg G-ALMg5Si	3.2381 3.3261	85 85	0,011 0,011	0,015 0,015	0,018 0,018	0,023 0,023	0,031 0,031	0,038 0,038	0,045 0,045	0,050 0,050	
Alu-Gusslegierungen > 12% Si aluminium alloy castings > 12% Si	≤ 300	≤ 90		G-ALSi12	3.2581	85	0,011	0,015	0,018	0,023	0,031	0,038	0,045	0,050		
Kupfer/Copper	Kupfer-Zink-Legierungen copper-zinc alloys (brass)	≤ 470			CuZn40 CuZn38Pb1,5	2.0360 2.0371										
	Kupfer-Zinn-Legierungen copper-tin alloys (bronze)	≤ 700			CuSn6 CuSn8	2.1020 2.1030										
	Kupfer-Aluminium-Legierungen copper-aluminium alloys	≤ 600			CuAl8 CuAl9Mn2	2.0920 2.0960										
Nickel	warmfeste Nickellegierungen heat resistant nickel alloys	≤ 850			NiCu30Fe	2.4360										
	hochwarmfeste Nickellegierungen highly heat resistant nickel alloys	≤ 1400			Inconel® 718	2.4668										
	hochwarmfeste Nickellegierungen highly heat resistant nickel alloys	≤ 1400			Haynes® 25											

Die angegebenen Werte sind Erfahrungswerte, die bei optimalen Bedingungen realisierbar sind. Diese Werte sind abhängig von Gewindeart, Gewindetiefe, Maschine (Steifigkeit, Aufspannung etc.) und Ausführung des Werkzeuges. Je nach Bedarf müssen diese Werte den Gegebenheiten angepasst werden. Bei langspanenden Werkstoffen kann ein- oder mehrfaches Entspannen notwendig sein!



GFW-Q		GFW-Q TiCN	
v_c	f_z [mm]	v_c	f_z [mm]
[m/min]		[m/min]	
70 - 90 70 - 90	0,13 - 0,20 0,13 - 0,20	105 - 125 105 - 125	0,13 - 0,20 0,13 - 0,20
95 - 115 70 - 80	0,13 - 0,20 0,13 - 0,20	140 - 160 100 - 120	0,13 - 0,20 0,13 - 0,20
95 - 115 75 - 95	0,13 - 0,20 0,13 - 0,20	140 - 160 115 - 135	0,13 - 0,20 0,13 - 0,20
55 - 75 50 - 70	0,13 - 0,20 0,13 - 0,20	85 - 105 75 - 95	0,13 - 0,20 0,13 - 0,20
35 - 55 50 - 70	0,10 - 0,18 0,13 - 0,20	55 - 75 75 - 95	0,10 - 0,18 0,13 - 0,20
25 - 45 25 - 45	0,10 - 0,18 0,10 - 0,18	40 - 60 40 - 60	0,10 - 0,18 0,10 - 0,18
30 - 50 25 - 45	0,10 - 0,18 0,10 - 0,18	45 - 65 40 - 60	0,10 - 0,18 0,10 - 0,18
25 - 45 20 - 40	0,10 - 0,18 0,10 - 0,18	40 - 60 30 - 50	0,10 - 0,18 0,10 - 0,18
20 - 40 20 - 40	0,10 - 0,18 0,10 - 0,18	30 - 50 30 - 50	0,10 - 0,18 0,10 - 0,18
80 - 100 65 - 85	0,15 - 0,23 0,13 - 0,20	120 - 140 95 - 115	0,15 - 0,23 0,13 - 0,20
60 - 80 55 - 75	0,15 - 0,23 0,13 - 0,20	90 - 110 85 - 105	0,15 - 0,23 0,13 - 0,20
55 - 75 60 - 80	0,15 - 0,23 0,15 - 0,23	85 - 105 90 - 110	0,15 - 0,23 0,15 - 0,23
20 - 40 15 - 35	0,13 - 0,20 0,13 - 0,20	35 - 55 30 - 50	0,13 - 0,20 0,13 - 0,20
10 - 30 10 - 30	0,13 - 0,20 0,13 - 0,20	20 - 40 20 - 40	0,13 - 0,20 0,13 - 0,20
10 - 30	0,13 - 0,20	20 - 40	0,13 - 0,20
325 - 345 305 - 325	0,21 - 0,29 0,21 - 0,29	470 - 490 440 - 460	0,21 - 0,29 0,21 - 0,29
325 - 345 305 - 325	0,21 - 0,29 0,21 - 0,29	470 - 490 440 - 460	0,21 - 0,29 0,21 - 0,29
280 - 300 290 - 310	0,21 - 0,29 0,21 - 0,29	400 - 420 415 - 435	0,21 - 0,29 0,21 - 0,29
280 - 300 250 - 270	0,21 - 0,29 0,21 - 0,29	400 - 420 365 - 385	0,21 - 0,29 0,21 - 0,29
325 - 345 305 - 325	0,21 - 0,29 0,21 - 0,29	470 - 490 440 - 460	0,21 - 0,29 0,21 - 0,29
315 - 335	0,21 - 0,29	455 - 475	0,21 - 0,29
170 - 190 190 - 210	0,21 - 0,29 0,21 - 0,29	250 - 270 275 - 295	0,21 - 0,29 0,21 - 0,29
175 - 195 190 - 210	0,21 - 0,29 0,21 - 0,29	255 - 275 275 - 295	0,21 - 0,29 0,21 - 0,29
170 - 190 175 - 195	0,21 - 0,29 0,21 - 0,29	250 - 270 255 - 275	0,21 - 0,29 0,21 - 0,29
20 - 40	0,06 - 0,12	30 - 50	0,06 - 0,12
5 - 15	0,05 - 0,11	10 - 30	0,05 - 0,11
5 - 15	0,05 - 0,11	15 - 35	0,05 - 0,11

The values given are empirical values that can be realised under optimal conditions. These values depend on the type of thread, thread depth, machine (rigidity, clamping etc.) and design of the tool. Depending on the requirements, these values must be adapted to the conditions. In the case of long-chipping materials, it may be necessary to remove chips from the thread once or several times!



GF^{SHARK} / GFM^{SHARK} / GFT^{SHARK*}

HOCHLEISTUNGS-GEWINDEFÄHRER

HIGH PERFORMANCE THREAD MILLING CUTTERS

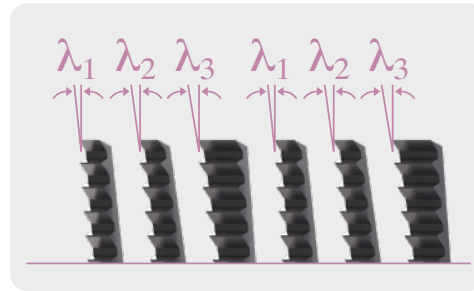

- universal einsetzbar
(Stahl- und Gusseisenwerkstoffe, NE-Metalle, Nickellegierungen)
- vibrationsarm
- hohe Oberflächengüte
- kurze Taktzeit
- hohe Standzeit
- ungleiche Spiralsteigung
- linksspiralisiert
- rechtsschneidend
- hohe Zähnezahl

- universally applicable
(steels, cast iron, non ferrous metals, nickel alloys)
- low vibration
- high surface quality
- short cycle time
- long tool life
- unequal spiral pitch
- left hand spiral flutes
- right hand cutting
- high number of teeth

* siehe Seite 84

* see page 84

GF SHARK

VHM Hochleistungs-Gewindefräser für Innengewinde

Metrisches ISO-Gewinde DIN 13

auch verwendbar für EG metrisches ISO-Gewinde DIN 8140-2 und metrisches ISO-Feingewinde DIN 13 ab Regelgewindedurchmesser

Ausführung: 2 x D, Zylinderschaft mit Kühlkanal und Linksspiralnuten, rechtsschneidend

Solid carbide high performance thread milling cutters for internal threads

ISO metric thread DIN 13

also suitable for STI ISO metric thread DIN 8140-2 and metric ISO fine thread DIN 13 from standard thread diameter
Specification: 2 x D, straight shank with internal coolant and left hand spiral flutes, right hand cutting

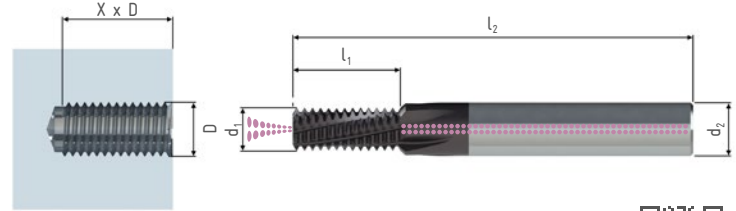
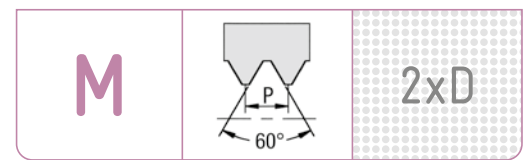

→HA (Zyl.-Schaft nach DIN 6535, Straight shank according to DIN 6535)

ORDER-CODE → GF SHARK →							2 x D	
D	P mm	l ₁	l ₂	d ₂	Z Nuten- zahl No. of flutes	ALTiN	Art.-Nr.	€
M 3	0,5	6,75	54	6	4		312621	146,00
M 4	0,7	8,75	54	6	6		312480	131,00
M 5	0,8	10,75	58	6	6		312524	134,00
M 6	1	13,45	58	6	6		312526	134,00
M 8	1,25	18,10	68	8	6		312527	148,00
M 10	1,5	21,70	80	10	6		312528	163,00
M 12	1,75	25,40	82	10	6		312529	201,00
M 14	2	31,10	92	12	6		312530	227,00

GFM SHARK

VHM Hochleistungs-Gewindefräser für Innengewinde

Metrisches ISO-Gewinde DIN 13

auch verwendbar für EG metrisches ISO-Gewinde DIN 8140-2

Ausführung: Zylinderschaft mit Kühlkanal und Linksspiralnuten, rechtsschneidend

Solid carbide high performance thread milling cutters for internal threads

ISO metric thread DIN 13

also suitable for STI ISO metric thread DIN 8140-2
Specification: straight shank with internal coolant and left hand spiral flutes, right hand cutting

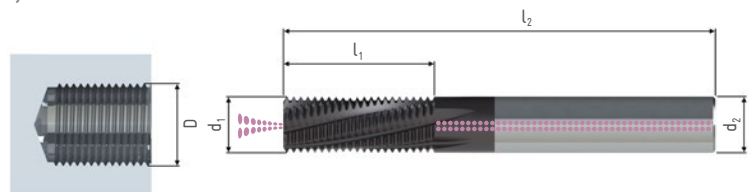

→HA (Zyl.-Schaft nach DIN 6535, Straight shank according to DIN 6535)

ORDER-CODE → GFM SHARK M →									
d ₁ Fräser Nenn-Ø Cutter nom. Ø	P mm	D ≥ für Gew.-Ø for thread Ø	l ₁	l ₂	d ₂	Z Nuten- zahl No. of flutes	ALTiN	Art.-Nr.	€
12	1	14	31,45	92	12	6		312534	249,00
12	1,5	16	32,20	92	12	6		312535	250,00
12	2	16	30,95	92	12	6		312536	260,00
16	1	18	40,45	106	16	8		312537	347,00
16	1,5	20	41,20	106	16	8		312538	312,00
16	2	20	40,95	106	16	8		312540	322,00
20	1,5	24	51,70	120	20	8		312541	434,00
20	2	26	50,90	120	20	8		312542	443,00
20	3	27	52,35	120	20	8		312543	458,00

Beachten Sie den kleinsten fräsbaren Gewindedurchmesser D ≥

Caution - please look at the smallest thread diameter D ≥ for the GFM tool system

→ HB



→ HE



Zyl.-Schaft nach DIN 6535 HB oder HE, kein Zuschlag, keine Rücknahme möglich
Straight shank according to DIN 6535 HB or HE, no extra charge, no withdrawal possible

→ K

Kühlkanal
internal coolant



GF

Vollhartmetall-Gewindefräser für Innengewinde

Metrisches ISO-Gewinde DIN 13

auch verwendbar für EG metrisches ISO-Gewinde DIN 8140-2

Ausführung: 1,5 x D bzw. 2 x D
Zylinderschaft und Rechtsspiralnuten

Solid carbide thread milling cutters for internal threads

ISO metric thread DIN 13
also suitable for STI ISO metric thread DIN 8140-2
Specification: 1.5 x D resp. 2 x D
Straight shank and right hand spiral flutes

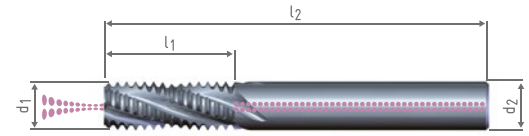
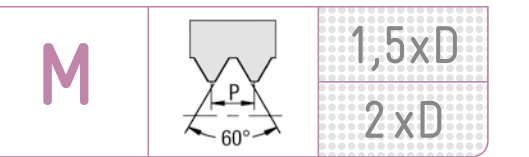
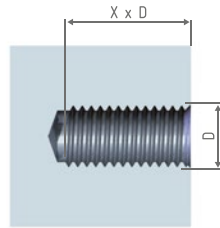

→HA (Zyl.-Schaft nach DIN 6535, Straight shank according to DIN 6535)

ORDER-CODE → GF						1,5 x D K		1,5 x D KT		1,5 x D KF						
D	P mm	l ₁	l ₂	d ₂	Z Nutenzahl No. of flutes	blank uncoated	TiCN	TiCN	TiCN	TiAlN	TiAlN					
↓																
						Art.-Nr.	€	Art.-Nr.	€	Art.-Nr.	€					
M 3	0,5					GFS verwenden (siehe Seite 72) use GFS (see page 72)										
M 4	0,7															
M 5	0,8															
M 6	1	10,50	54	6	3	308760	108,00	308772	127,00	308766	127,00					
M 8	1,25	14,30	54	6	3	308761	119,00	308773	141,00	308767	141,00					
M 10	1,5	17,20	64	8	4	308762	129,00	308774	153,00	308768	153,00					

ORDER-CODE → GF						2 x D		2 x D K		2 x D T		2 x D KT		2 x D F		2 x D KF								
D	P mm	l ₁	l ₂	d ₂	Z Nutenzahl No. of flutes	blank uncoated	TiCN	TiCN	TiCN	TiCN	TiAlN	TiAlN	TiAlN	TiAlN	TiAlN	TiAlN								
↓																								
						Art.-Nr.	€	Art.-Nr.	€	Art.-Nr.	€	Art.-Nr.	€	Art.-Nr.	€	Art.-Nr.	€							
M 2	0,4					GFS verwenden (siehe Seite 73) use GFS (see page 73)																		
M 3	0,5																							
M 3,5	0,6																							
M 4	0,7																							
M 5	0,8																							
M 6	1	13,50	54	6	3	300134	115,00	300195	115,00	300609	134,00	301148	134,00	300131	134,00	300199	134,00							
M 8	1,25	18,10	54	6	3	300192	125,00	300135	125,00	301131	148,00	301104	148,00	300132	148,00	300136	148,00							
M 10	1,5	21,70	64	8	4	300092	139,00	300130	139,00	300772	163,00	301149	163,00	300133	163,00	300137	163,00							
M 12	1,75	27,10	74	10	4			300122	177,00			301105	201,00			300200	201,00							
M 14	2	30,90	74	10	4			300196	202,00			301108	227,00			300201	227,00							
M 16	2	34,90	80	12	4			300197	230,00			301063	256,00			300202	256,00							
M 18/20	2,5	41,10	90	14	4			300198	270,00			301150	296,00			300205	296,00							



Zyl.-Schaft nach DIN 6535 HB oder HE, kein Zuschlag, keine Rücknahme möglich
Straight shank according to DIN 6535 HB or HE, no extra charge, no withdrawal possible



GF

Vollhartmetall-Gewindefräser für Innengewinde

Metrisches ISO-Gewinde DIN 13

auch verwendbar für EG metrisches ISO-Gewinde DIN 8140-2

Ausführung: 2,5 x D bzw. 3 x D
Zylinderschaft und Rechtsspiralnuten

Solid carbide thread milling cutters for internal threads

ISO metric thread DIN 13
also suitable for STI ISO metric thread DIN 8140-2
Specification: 2.5 x D resp. 3 x D
Straight shank and right hand spiral flutes

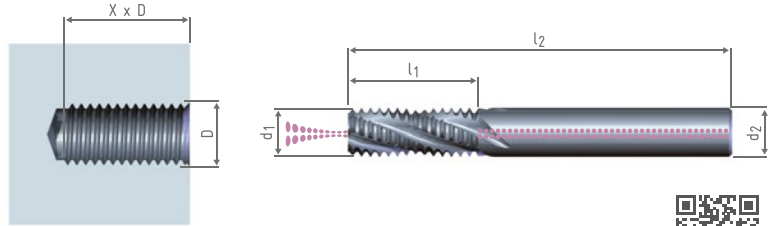
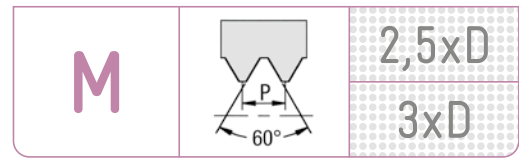

→ HA (Zyl.-Schaft nach DIN 6535, Straight shank according to DIN 6535)

ORDER-CODE → GF						2,5 x D	2,5 x D K	2,5 x D T	2,5 x D KT	2,5 x D F	2,5 x D KF											
D	P mm	l ₁	l ₂	d ₂	z Nuten- zahl No. of flutes	blank uncoated	TiCN		TiAlN													
↓																						
						Art.-Nr.	€	Art.-Nr.	€	Art.-Nr.	€	Art.-Nr.	€	Art.-Nr.	€							
M 3	0,5					GFS verwenden (siehe Seite 74) use GFS (see page 74)																
M 3,5	0,6																					
M 4	0,7																					
M 5	0,8																					
M 6	1	16,50	54	6	3	300472	122,00	300716	122,00	305051	142,00	301772	142,00	302291	142,00	300870	142,00					
M 8	1,25	21,80	54	6	3	300731	133,00	300725	133,00	310000	157,00	301578	157,00	300857	157,00	302129	157,00					
M 10	1,5	26,20	64	8	4	300858	148,00	300771	148,00	310001	173,00	301606	173,00	300859	173,00	302433	173,00					
M 12	1,75	30,60	74	10	4			300455	188,00			300630	214,00			300717	214,00					
M 14	2	36,90	74	10	4			300887	215,00			301513	241,00			300889	241,00					
M 16	2	42,90	90	12	4			300519	245,00			301226	272,00			300892	272,00					
M 18/20	2,5	48,60	108	14	4			300893	287,00			301312	315,00			300895	315,00					

ORDER-CODE → GF						3 x D	3 x D K	3 x D T	3 x D KT	3 x D F	3 x D KF										
D	P mm	l ₁	l ₂	d ₂	z Nuten- zahl No. of flutes	blank uncoated	TiCN		TiAlN												
↓																					
						Art.-Nr.	€	Art.-Nr.	€	Art.-Nr.	€	Art.-Nr.	€	Art.-Nr.	€						
M 3	0,5					GFS verwenden (siehe Seite 75) use GFS (see page 75)															
M 3,5	0,6																				
M 4	0,7																				
M 5	0,8																				
M 6	1	19,50	60	6	3	300589	146,00	300868	146,00	310002	170,00	304854	170,00	300855	170,00	300872	170,00				
M 8	1,25	26,80	62	6	3	300068	160,00	300645	160,00	310003	189,00	304855	189,00	302306	189,00	300876	189,00				
M 10	1,5	32,20	72	8	4	302315	177,00	300468	177,00	310004	208,00	301456	208,00	302322	208,00	300881	208,00				
M 12	1,75	37,60	84	10	4			300518	226,00			301271	257,00			300761	257,00				
M 14	2	42,90	85	10	4			300888	258,00			310005	289,00			302456	289,00				
M 16	2	48,90	102	12	4			302464	295,00			310006	326,00			302469	326,00				
M 18/20	2,5	61,10	108	14	4			300894	344,00			304856	378,00			302484	378,00				



Zyl.-Schaft nach DIN 6535 HB oder HE, kein Zuschlag, keine Rücknahme möglich
Straight shank according to DIN 6535 HB or HE, no extra charge, no withdrawal possible



GF

Vollhartmetall-Gewindefräser für Innengewinde

MJ-Gewinde Luft- und Raumfahrt DIN ISO 5855

Ausführung: 2 x D

Zylinderschaft mit Kühlkanal und Rechtsspiralnuten

Solid carbide thread milling cutters for internal threads

MJ thread Aerospace DIN ISO 5855

Specification: 2 x D

Straight shank with internal coolant and right hand spiral flutes

MJ

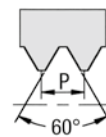

2xD

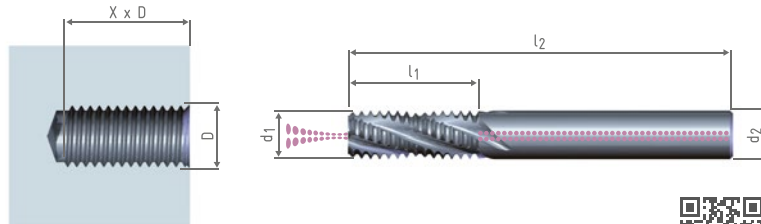

→HA (Zyl.-Schaft nach DIN 6535, Straight shank according to DIN 6535)

ORDER-CODE → GF						→ 2 x D T	
D	P mm	l ₁	l ₂	d ₂	z Nuten- zahl No. of flutes	TiCN	
↓							
						Art.-Nr.	€
MJ 4*	0,7	8,75	48	6	3	305881	184,00
MJ 5*	0,8	10,80	54	6	3	305882	197,00
MJ 6	1	13,50	54	6	3	305883	217,00
MJ 8	1,25	18,10	54	6	3	305884	221,00
MJ 10	1,5	21,75	64	8	4	305885	250,00
MJ 12	1,75	27,10	74	10	4	305886	331,00

* Ausführung GFS

* design GFS

→ HB

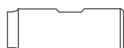

→ HE



Zyl.-Schaft nach DIN 6535 HB oder HE, kein Zuschlag, keine Rücknahme möglich
Straight shank according to DIN 6535 HB or HE, no extra charge, no withdrawal possible

GF

Vollhartmetall-Gewindefräser für Innengewinde

Metrisches ISO-Feingewinde DIN 13

Ausführung: 2 x D bzw. 2,5 x D
Zylinderschaft und Rechtsspiralnuten

Solid carbide thread milling cutters for internal threads

ISO metric fine thread DIN 13
Specification: 2 x D resp. 2.5 x D
Straight shank and right hand spiral flutes

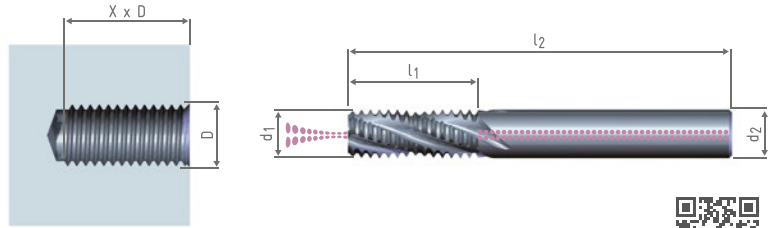
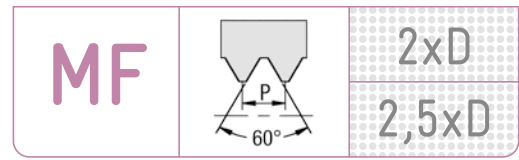

→HA (Zyl.-Schaft nach DIN 6535, Straight shank according to DIN 6535)

ORDER-CODE → GF		→ 2 x D				2 x D K		2 x D T		2 x D KT		2 x D F		2 x D KF			
D	P mm	l ₁	l ₂	d ₂	z Nuten- zahl No. of flutes	blank uncoated	TiCN		TiAlN		TiAlN						
↓	↓																
						Art.-Nr.	€	Art.-Nr.	€	Art.-Nr.	€	Art.-Nr.	€	Art.-Nr.	€		
M 4	0,5	GFS verwenden (siehe Seite 77) use GFS (see page 77)															
M 5	0,5	GFS verwenden (siehe Seite 77) use GFS (see page 77)															
M 6	0,5	12,70	54	6	3	300512	164,00	300896	164,00	310008	183,00	310010	183,00	301991	183,00	302498	183,00
M 8	0,5	17,70	54	6	3			300127	150,00			304829	174,00			301836	174,00
M 6	0,75	13,10	54	6	3	300513	141,00	300897	141,00	310009	160,00	310011	160,00	300578	160,00	302511	160,00
M 8	0,75	16,80	54	6	3			300126	146,00			301196	169,00			300228	169,00
M 8	1	17,50	54	6	3			300099	140,00			301194	163,00			300229	163,00
M 10	1	21,50	64	8	4			300125	162,00			301351	187,00			300230	187,00
M 12	1	25,50	74	10	4			300123	202,00			301198	227,00			300232	227,00
M 10	1,25	21,80	64	8	4			300124	155,00			310012	180,00			300231	180,00
M 12	1,5	26,20	74	10	4			300128	202,00			301113	227,00			300233	227,00
M 14	1,5	30,70	80	12	4			305719	231,00			305761	258,00			305762	258,00
M 16	1,5	33,70	90	14	4			308132	294,00			308134	331,00			308135	331,00

ORDER-CODE → GF		→ 2,5 x D K				2,5 x D KT		2,5 x D KF					
D	P mm	l ₁	l ₂	d ₂	z Nuten- zahl No. of flutes	blank uncoated	TiCN		TiAlN				
↓	↓												
						Art.-Nr.	€	Art.-Nr.	€	Art.-Nr.	€	Art.-Nr.	€
M 4	0,5	GFS verwenden (siehe Seite 78) use GFS (see page 78)											
M 5	0,5	GFS verwenden (siehe Seite 78) use GFS (see page 78)											
M 6	0,5	15,20	54	6	3	302600	174,00	310015	195,00	302853	195,00		
M 8	0,5	20,20	54	6	3	302602	159,00	310017	184,00	302855	184,00		
M 6	0,75	15,30	54	6	3	302601	149,00	310016	170,00	302854	170,00		
M 8	0,75	20,60	54	6	3	300918	155,00	305002	179,00	302856	179,00		
M 8	1	20,50	54	6	3	300827	148,00	310018	173,00	300826	173,00		
M 10	1	25,50	64	8	4	300919	172,00	310019	199,00	300951	199,00		
M 12	1	30,50	74	10	4	300921	214,00	310020	241,00	302858	241,00		
M 10	1,25	25,60	64	8	4	300920	165,00	301769	192,00	302857	192,00		
M 12	1,5	30,70	74	10	4	300815	214,00	310021	241,00	302859	241,00		
M 14	1,5	38,20	90	12	4	305720	252,00	305763	281,00	305764	281,00		
M 16	1,5	41,20	90	14	4	308133	318,00	308136	358,00	308137	358,00		

3 x D auf Anfrage

3 x D on request



Zyl.-Schaft nach DIN 6535 HB oder HE, kein Zuschlag, keine Rücknahme möglich
Straight shank according to DIN 6535 HB or HE, no extra charge, no withdrawal possible



Kühlkanal
internal coolant



GFS

Vollhartmetall-Gewindefräser für Innengewinde

Metrisches ISO-Gewinde DIN 13

Ausführung: 1,5 x D
45° Senkfase, Zylinderschaft und Rechtsspiralnuten

Solid carbide thread milling cutters for internal threads

ISO metric thread DIN 13
Specification: 1.5 x D
45° chamfer for countersinking, straight shank and right hand spiral flutes

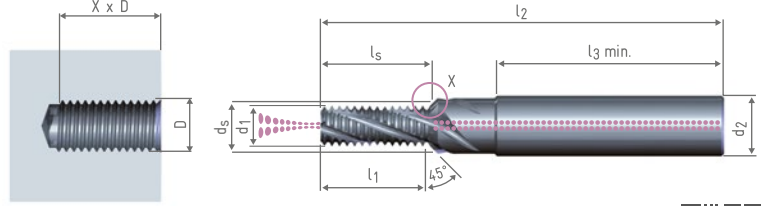
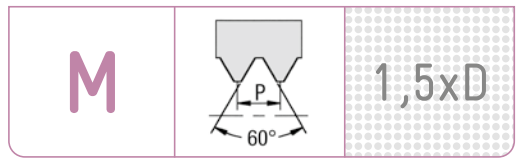
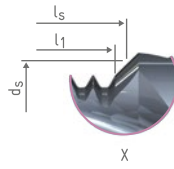

→ HA (Zyl.-Schaft nach DIN 6535, Straight shank according to DIN 6535)

ORDER-CODE → GFS										1,5 x D	1,5 x D T	1,5 x D F
D	P mm	l ₁	l ₂	l _{3 min.}	d ₂	d _s	l _s	Z Nutenzahl No. of flutes	blank uncoated	TiCN	TiAlN	
M 2	0,4	3,40	48	36	6	2,1	3,7	2	Art.-Nr. €	Art.-Nr. €	Art.-Nr. €	
M 2,5	0,45	4,25	48	36	6	2,6	4,6	3	300016 149,00	304767 164,00	300347 164,00	
M 3	0,5	5,25	48	36	6	3,2	5,7	3	300605 149,00	304789 164,00	304005 164,00	
M 3,5	0,6	6,30	48	36	6	3,7	6,8	3	300017 123,00	301382 138,00	300038 138,00	
M 4	0,7	7,35	48	36	6	4,2	7,9	3	300957 138,00	304790 153,00	304020 153,00	
M 5	0,8	9,15	54	36	6	5,3	9,9	3	300018 107,00	300063 125,00	300039 125,00	
M 6	1	10,50	62	36	8	6,3	11,3	3	300019 109,00	301329 127,00	300050 127,00	
M 8	1,25	13,10	74	40	10	8,4	14,1	3	300020 124,00	301339 149,00	300040 149,00	
M 10	1,5	17,20	80	45	12	10,5	18,4	4	300021 153,00	301242 179,00	300056 179,00	
									301778 178,00	301825 206,00	301804 206,00	

ORDER-CODE → GFS										1,5 x D K	1,5 x D KT	1,5 x D KF
D	P mm	l ₁	l ₂	l _{3 min.}	d ₂	d _s	l _s	Z Nutenzahl No. of flutes	blank uncoated	TiCN	TiAlN	
M 4	0,7	7,35	48	36	6	4,2	7,9	3	Art.-Nr. €	Art.-Nr. €	Art.-Nr. €	
M 5	0,8	9,15	54	36	6	5,3	9,9	3	300905 107,00	304574 125,00	301033 125,00	
M 6	1	10,50	62	36	8	6,3	11,3	3	300908 109,00	304768 127,00	300983 127,00	
M 8	1,25	13,10	74	40	10	8,4	14,1	3	300705 124,00	301191 149,00	300539 149,00	
M 10	1,5	17,20	80	45	12	10,5	18,4	4	300073 153,00	300612 179,00	300110 179,00	
M 12	1,75	20,05	90	45	14	12,6	21,5	4	300075 178,00	301352 206,00	300348 206,00	
M 14	2	24,95	102	48	16	14,7	26,5	4	300077 230,00	301383 259,00	300349 259,00	
M 16	2	26,95	102	48	18	16,8	28,6	4	300345 285,00	304769 316,00	300350 316,00	
M 18/20	2,5	33,65	125	50	20	21,0	36,7	4	300346 349,00	300843 378,00	300111 378,00	
									301102 608,00	301400 654,00	301852 654,00	



Zyl.-Schaft nach DIN 6535 HB oder HE, kein Zuschlag, keine Rücknahme möglich
Straight shank according to DIN 6535 HB or HE, no extra charge, no withdrawal possible



GFS

Vollhartmetall-Gewindefräser für Innengewinde

Metrisches ISO-Gewinde DIN 13

Ausführung: 2 x D

45° Senkfase, Zylinderschaft und Rechtsspiralnuten

Solid carbide thread milling cutters for internal threads

ISO metric thread DIN 13

Specification: 2 x D

45° chamfer for countersinking, straight shank and right hand spiral flutes

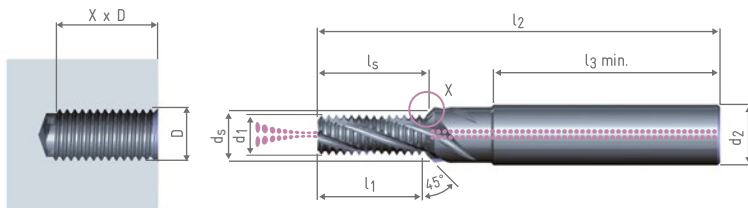
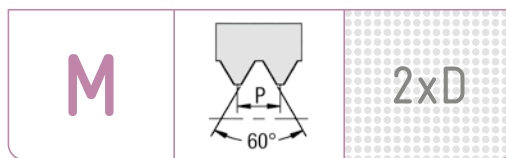
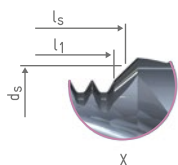

→HA (Zyl.-Schaft nach DIN 6535, Straight shank according to DIN 6535)

ORDER-CODE → GFS									2 x D	2 x D T	2 x D F			
D	P mm	l ₁	l ₂	l _{3 min.}	d ₂	d _s	l _s	Z Nuten- zahl No. of flutes	blank uncoated	TiCN	TiAlN			
↓														
									Art.-Nr.	€	Art.-Nr.	€	Art.-Nr.	€
M 2	0,4	4,60	48	36	6	2,1	4,9	2	300157	158,00	301384	173,00	300354	173,00
M 2,5	0,45	6,05	48	36	6	2,6	6,4	3	300606	158,00	301341	173,00	300732	173,00
M 3	0,5	6,75	48	36	6	3,2	7,2	3	300160	131,00	301170	146,00	300355	146,00
M 3,5	0,6	8,10	48	36	6	3,7	8,6	3	301038	146,00	304791	161,00	304141	161,00
M 4	0,7	8,75	48	36	6	4,2	9,3	3	300163	113,00	301171	131,00	300356	131,00
M 5	0,8	10,75	54	36	6	5,3	11,5	3	300164	116,00	300571	134,00	300357	134,00
M 6	1	13,50	62	36	8	6,3	14,3	3	300165	131,00	301070	157,00	300358	157,00
M 8	1,25	18,10	74	40	10	8,4	19,1	3	300258	161,00	300572	188,00	300359	188,00
M 10	1,5	21,70	80	45	12	10,5	22,9	4	300259	190,00	300610	218,00	300360	218,00

ORDER-CODE → GFS									2 x D K	2 x D KT	2 x D KF			
D	P mm	l ₁	l ₂	l _{3 min.}	d ₂	d _s	l _s	Z Nuten- zahl No. of flutes	blank uncoated	TiCN	TiAlN			
↓														
									Art.-Nr.	€	Art.-Nr.	€	Art.-Nr.	€
M 4	0,7	8,75	48	36	6	4,2	9,3	3	300906	113,00	301172	131,00	300984	131,00
M 5	0,8	10,75	54	36	6	5,3	11,5	3	300907	116,00	301127	134,00	300985	134,00
M 6	1	13,50	62	36	8	6,3	14,3	3	300465	131,00	301095	157,00	300580	157,00
M 8	1,25	18,10	74	40	10	8,4	19,1	3	300166	161,00	301173	188,00	300364	188,00
M 10	1,5	21,70	80	45	12	10,5	22,9	4	300167	190,00	301174	218,00	300236	218,00
M 12	1,75	25,30	90	45	14	12,6	26,7	4	300168	243,00	301176	272,00	300365	272,00
M 14	2	30,95	102	48	16	14,7	32,5	4	300169	300,00	301085	331,00	300366	331,00
M 16	2	34,95	102	48	18	16,8	36,6	4	300170	367,00	304534	398,00	300238	398,00
M 18/20	2,5	41,15	125	50	20	21,0	44,2	4	301854	640,00	301133	688,00	300367	688,00



Zyl.-Schaft nach DIN 6535 HB oder HE, kein Zuschlag, keine Rücknahme möglich
Straight shank according to DIN 6535 HB or HE, no extra charge, no withdrawal possible



M
MF
MJ
EG M

G
Rc, R
Pg

UNC
UNF
UN
UNJF

NPT
NPTF

M
MF
M keg.
M taper

G
BSW
BSF
DIN 477
R, BA, Pg

UNC
UNF
UNEF
UN, UNS

NPSM
NPT
NPTF
Tr, Rd

M
MF

G
BSW
BSF
R, Pg
MF-EL

UNC, UNF
UNEF
UN, UNS
UNJF
UNJF

NPT
NPTF
Tr
EG

GFS

Vollhartmetall-Gewindefräser für Innengewinde

Metrisches ISO-Gewinde DIN 13

Ausführung: 2,5 x D
45° Senkfase, Zylinderschaft und Rechtsspiralnuten

Solid carbide thread milling cutters for internal threads

ISO metric thread DIN 13
Specification: 2.5 x D
45° chamfer for countersinking, straight shank and right hand spiral flutes

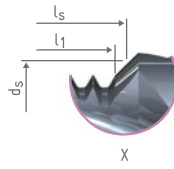

M

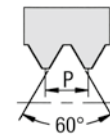

2,5xD

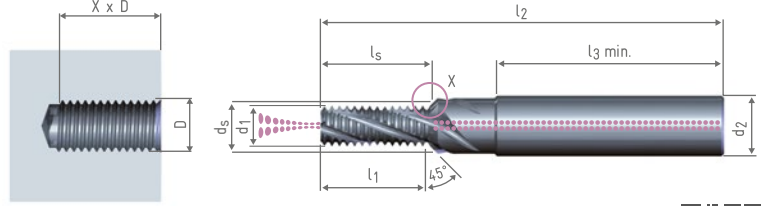

→ HA (Zyl.-Schaft nach DIN 6535, Straight shank according to DIN 6535)

ORDER-CODE → GFS									2,5 x D	2,5 x D T	2,5 x D F			
D	P mm	l ₁	l ₂	l _{3 min.}	d ₂	d _s	l _s	z Nutenzahl No. of flutes	blank uncoated	TiCN	TiAlN			
↓														
									Art.-Nr.	€	Art.-Nr.	€	Art.-Nr.	€
M 3	0,5	7,75	48	36	6	3,2	8,2	3	300954	139,00	305047	154,00	301047	154,00
M 3,5	0,6	9,30	48	36	6	3,7	9,8	3	301048	155,00	310045	170,00	304234	170,00
M 4	0,7	10,85	48	36	6	4,2	11,4	3	300793	120,00	310046	138,00	304243	138,00
M 5	0,8	13,15	54	36	6	5,3	13,9	3	300787	123,00	310047	141,00	301052	141,00
M 6	1	16,50	62	36	8	6,3	17,3	3	300188	139,00	301135	165,00	302008	165,00
M 8	1,25	21,85	74	40	10	8,4	22,8	3	300734	171,00	301250	198,00	301055	198,00
M 10	1,5	26,20	80	45	12	10,5	27,4	4	300738	201,00	304624	230,00	301057	230,00

ORDER-CODE → GFS									2,5 x D K	2,5 x D KT	2,5 x D KF			
D	P mm	l ₁	l ₂	l _{3 min.}	d ₂	d _s	l _s	z Nutenzahl No. of flutes	blank uncoated	TiCN	TiAlN			
↓														
									Art.-Nr.	€	Art.-Nr.	€	Art.-Nr.	€
M 4	0,7	10,85	48	36	6	4,2	11,4	3	301049	120,00	305038	138,00	304246	138,00
M 5	0,8	13,15	54	36	6	5,3	13,9	3	301050	123,00	305045	141,00	304259	141,00
M 6	1	16,50	62	36	8	6,3	17,3	3	300781	139,00	301302	165,00	301053	165,00
M 8	1,25	21,85	74	40	10	8,4	22,8	3	300650	171,00	304831	198,00	301056	198,00
M 10	1,5	26,20	80	45	12	10,5	27,4	4	300505	201,00	304618	230,00	301058	230,00
M 12	1,75	32,30	90	45	14	12,6	33,7	4	300718	258,00	304761	289,00	300834	289,00
M 14	2	36,95	102	48	16	14,7	38,5	4	300719	318,00	304995	349,00	304317	349,00
M 16	2	42,95	102	48	18	16,8	44,6	4	300720	389,00	300898	420,00	304334	420,00
M 18/20	2,5	48,65	125	50	20	21,0	51,7	4	300721	675,00	310048	722,00	304351	722,00

→ HB

→ HE

Zyl.-Schaft nach DIN 6535 HB oder HE, kein Zuschlag, keine Rücknahme möglich
Straight shank according to DIN 6535 HB or HE, no extra charge, no withdrawal possible

→ K Kühlkanal
internal coolant

GFS

Vollhartmetall-Gewindefräser für Innengewinde

Metrisches ISO-Gewinde DIN 13

Ausführung: 3 x D

45° Senkfase, Zylinderschaft und Rechtsspiralnuten

Solid carbide thread milling cutters for internal threads

ISO metric thread DIN 13

Specification: 3 x D

45° chamfer for countersinking, straight shank and right hand spiral flutes

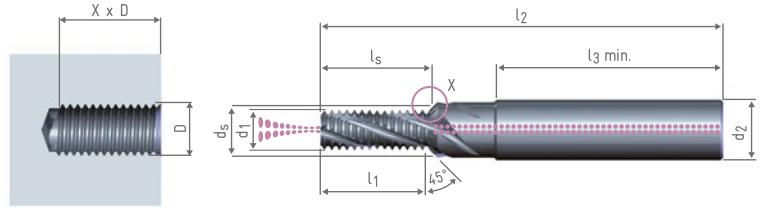
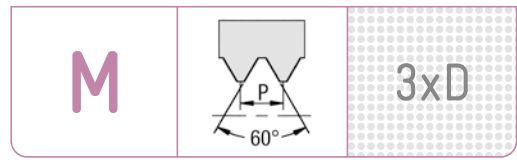
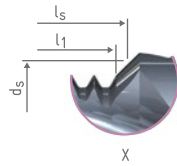

→HA (Zyl.-Schaft nach DIN 6535, Straight shank according to DIN 6535)

ORDER-CODE → GFS									3 x D	3 x D T	3 x D F			
D	P mm	l ₁	l ₂	l _{3 min.}	d ₂	d _s	l _s	z Nuten- zahl No. of flutes	blank uncoated	TiCN	TiAlN			
↓														
									Art.-Nr.	€	Art.-Nr.	€	Art.-Nr.	€
M 3	0,5	9,75	48	36	6	3,2	10,2	3	300189	164,00	310049	186,00	304384	186,00
M 3,5	0,6	11,10	54	36	6	3,7	11,6	3	304365	183,00	311000	205,00	304385	205,00
M 4	0,7	12,25	54	36	6	4,2	12,8	3	300837	141,00	304647	166,00	301371	166,00
M 5	0,8	15,55	54	36	6	5,3	16,3	3	300847	145,00	310051	170,00	310055	170,00
M 6	1	19,50	62	36	8	6,3	20,3	3	300602	164,00	310052	197,00	310056	197,00
M 8	1,25	25,60	74	40	10	8,4	26,6	3	300680	201,00	310053	235,00	301656	235,00
M 10	1,5	32,20	80	45	12	10,5	33,4	4	310054	238,00	310050	274,00	310057	274,00

ORDER-CODE → GFS									3 x D K	3 x D KT	3 x D KF			
D	P mm	l ₁	l ₂	l _{3 min.}	d ₂	d _s	l _s	z Nuten- zahl No. of flutes	blank uncoated	TiCN	TiAlN			
↓														
									Art.-Nr.	€	Art.-Nr.	€	Art.-Nr.	€
M 4	0,7	12,25	54	36	6	4,2	12,8	3	301071	141,00	310058	166,00	304386	166,00
M 5	0,8	15,55	54	36	6	5,3	16,3	3	301072	145,00	304853	170,00	304387	170,00
M 6	1	19,50	62	36	8	6,3	20,3	3	300759	164,00	310059	197,00	304388	197,00
M 8	1,25	25,60	74	40	10	8,4	26,6	3	300700	201,00	310060	235,00	304389	235,00
M 10	1,5	32,20	80	45	12	10,5	33,4	4	301073	238,00	310061	274,00	301081	274,00
M 12	1,75	37,55	90	45	14	12,6	39,0	4	301074	304,00	310062	342,00	304390	342,00
M 14	2	42,95	102	48	16	14,7	44,5	4	304366	375,00	310063	413,00	304391	413,00
M 16	2	48,95	102	48	18	16,8	50,6	4	304367	459,00	310064	497,00	304392	497,00
M 18/20	2,5	61,15	125	50	20	21,0	64,2	4	301075	800,00	310065	856,00	304393	856,00

→ HB



→ HE



Zyl.-Schaft nach DIN 6535 HB oder HE, kein Zuschlag, keine Rücknahme möglich
Straight shank according to DIN 6535 HB or HE, no extra charge, no withdrawal possible

→ K

Kühlkanal
internal coolant



M
MF
MJ
EG M

G
Rc, R
Pg

UNC
UNF
UN
UNJF

NPT
NPTF

M
MF
M keg.
M taper

G
BSW
BSF
DIN 477
R, BA, Pg

UNC
UNF
UNEF
UN, UNS

NPSM
NPT
NPTF
Tr, Rd

M
MF

G
BSW
BSF
R, Pg
MF-EL

UNC, UNF
UNEF
UN, UNS
UNJC
UNJF

NPT
NPTF
Tr
EG

GFS

Vollhartmetall-Gewindefräser für Innengewinde

Metrisches ISO-Feingewinde DIN 13

Ausführung: 1,5 x D

45° Senkfase, Zylinderschaft und Rechtsspiralnuten

Solid carbide thread milling cutters for internal threads

ISO metric fine thread DIN 13

Specification: 1.5 x D

45° chamfer for countersinking, straight shank and right hand spiral flutes

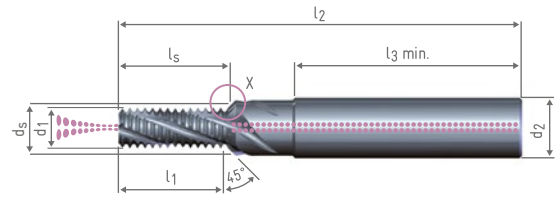
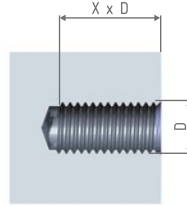
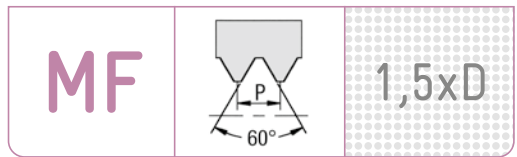
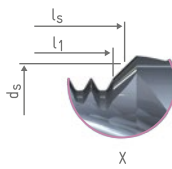

→HA (Zyl.-Schaft nach DIN 6535, Straight shank according to DIN 6535)

ORDER-CODE → GFS									1,5 x D KT	
D	P mm	l ₁	l ₂	l _{3 min.}	d ₂	d _s	l _s	z Nuten- zahl No. of flutes	TiCN	
↓	↓								Art.-Nr.	€
M 4	0,5	7,25	48	36	6	4,2	7,7	3	310070	182,00
M 5	0,5	8,75	54	36	6	5,3	9,3	3	310071	185,00
M 6	0,5	9,75	62	36	8	6,3	10,4	3	310078	204,00
M 8	0,5	12,75	74	40	10	8,4	13,5	3	301747	232,00
M 6	0,75	10,10	62	36	8	6,3	10,8	3	304684	180,00
M 8	0,75	13,10	74	40	10	8,4	13,9	3	310072	205,00
M 8	1	13,45	74	40	10	8,4	14,4	3	310073	199,00
M 10	1	16,45	80	45	12	10,5	17,5	4	304645	238,00
M 12	1	19,45	90	45	14	12,6	20,6	4	310075	305,00
M 10	1,25	16,85	80	45	12	10,5	20,6	4	310074	230,00
M 12	1,5	20,20	90	45	14	12,6	21,5	4	304646	293,00
M 14	1,5	23,20	102	48	16	14,7	24,6	4	301415	351,00
M 16	1,5	26,20	102	48	18	16,8	27,7	4	301471	418,00

→ HB



→ HE



Zyl.-Schaft nach DIN 6535 HB oder HE, kein Zuschlag, keine Rücknahme möglich
Straight shank according to DIN 6535 HB or HE, no extra charge, no withdrawal possible

→ K

Kühlkanal
internal coolant

GFS

Vollhartmetall-Gewindefräser für Innengewinde

Metrisches ISO-Feingewinde DIN 13

Ausführung: 2 x D

45° Senkfase, Zylinderschaft und Rechtsspiralnuten

Solid carbide thread milling cutters for internal threads

ISO metric fine thread DIN 13

Specification: 2 x D

45° chamfer for countersinking, straight shank and right hand spiral flutes

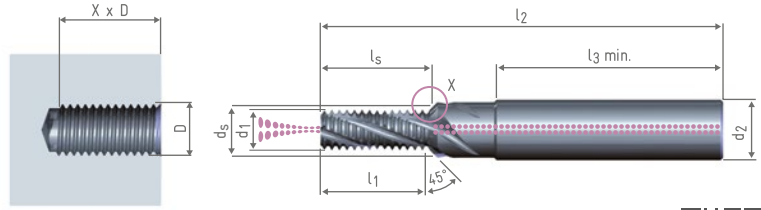
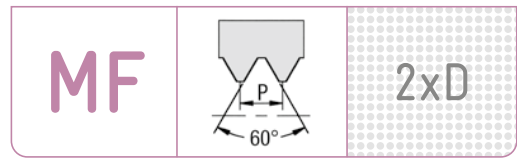
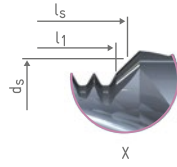

→HA (Zyl.-Schaft nach DIN 6535, Straight shank according to DIN 6535)

ORDER-CODE → GFS									→ 2 x D KT	
D	P mm	l ₁	l ₂	l _{3 min.}	d ₂	d _s	l _s	z Nuten- zahl No. of flutes	TiCN	
↓	↓								Art.-Nr.	€
M 4	0,5	8,75	48	36	6	4,2	9,2	3	305134	182,00
M 5	0,5	10,75	54	36	6	5,3	11,3	3	310083	185,00
M 6	0,5	12,75	62	36	8	6,3	13,4	3	310084	204,00
M 8	0,5	17,75	74	40	10	8,4	18,5	3	301591	232,00
M 6	0,75	13,10	62	36	8	6,3	13,8	3	301465	180,00
M 8	0,75	16,85	74	40	10	8,4	17,7	3	301658	205,00
M 8	1	17,45	74	40	10	8,4	18,4	3	301466	199,00
M 10	1	21,45	80	45	12	10,5	22,5	4	301522	238,00
M 12	1	25,45	90	45	14	12,6	26,6	4	301487	305,00
M 10	1,25	21,85	80	45	12	10,5	22,9	4	301288	230,00
M 12	1,5	26,20	90	45	14	12,6	27,5	4	301345	293,00
M 14	1,5	30,70	102	48	16	14,7	32,1	4	301213	351,00
M 16	1,5	33,70	102	48	18	16,8	35,2	4	301220	418,00

→ HB



→ HE



Zyl.-Schaft nach DIN 6535 HB oder HE, kein Zuschlag, keine Rücknahme möglich
Straight shank according to DIN 6535 HB or HE, no extra charge, no withdrawal possible

→ K

Kühlkanal
internal coolant



M
MF
MJ
EG M

G
Rc, R
Pg

UNC
UNF
UN
UNJF

NPT
NPTF

M
MF

M keg.
M taper

G
BSW
BSF
DIN 477
R, BA, Pg

UNC
UNF
UNEF
UN, UNS

NPSM
NPT
NPTF
Tr, Rd

M
MF

G
BSW
BSF
R, Pg
MF-EL

UNC, UNF
UNEF
UN, UNS
UNJC
UNJF

NPT
NPTF
Tr
EG

M
MF

G
BSW
BSF
R, Pg
MF-EL

UNC, UNF
UNEF
UN, UNS
UNJC
UNJF

NPT
NPTF
Tr
EG

GFS

Vollhartmetall-Gewindefräser für Innengewinde

Metrisches ISO-Feingewinde DIN 13

Ausführung: 2,5 x D

45° Senkfase, Zylinderschaft und Rechtsspiralnuten

Solid carbide thread milling cutters for internal threads

ISO metric fine thread DIN 13

Specification: 2.5 x D

45° chamfer for countersinking, straight shank and right hand spiral flutes

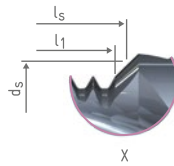

MF

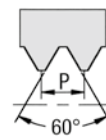

2,5xD

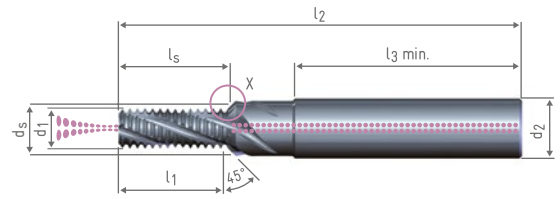
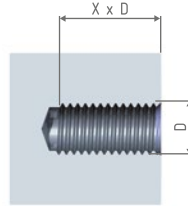

→HA (Zyl.-Schaft nach DIN 6535, Straight shank according to DIN 6535)

ORDER-CODE → GFS									2,5 x D KT	
D	P mm	l ₁	l ₂	l _{3 min.}	d ₂	d _s	l _s	Z Nuten- zahl No. of flutes	TiCN	
↓	↓								Art.-Nr.	€
M 4	0,5	10,25	48	36	6	4,2	10,7	3	310106	192,00
M 5	0,5	12,75	54	36	6	5,3	13,3	3	310107	195,00
M 6	0,5	15,25	62	36	8	6,3	15,9	3	310108	215,00
M 8	0,5	20,25	74	40	10	8,4	21,0	3	310109	244,00
M 6	0,75	15,35	62	36	8	6,3	16,1	3	301754	189,00
M 8	0,75	20,60	74	40	10	8,4	21,4	3	310110	216,00
M 8	1	20,45	74	40	10	8,4	21,4	3	310111	209,00
M 10	1	25,45	80	45	12	10,5	26,5	4	301750	251,00
M 12	1	30,45	90	45	14	12,6	31,6	4	310113	322,00
M 10	1,25	26,85	80	45	12	10,5	27,9	4	310112	242,00
M 12	1,5	30,70	90	45	14	12,6	32,0	4	301669	309,00
M 14	1,5	38,20	102	48	16	14,7	39,6	4	310114	370,00
M 16	1,5	41,20	102	48	18	16,8	42,7	4	310115	441,00

3 x D auf Anfrage

3 x D on request

→ HB



→ HE



Zyl.-Schaft nach DIN 6535 HB oder HE, kein Zuschlag, keine Rücknahme möglich
Straight shank according to DIN 6535 HB or HE, no extra charge, no withdrawal possible

→ K

Kühlkanal
internal coolant

GFM

Vollhartmetall-Gewindefräser
für Innengewinde

Metrisches ISO-Gewinde DIN 13

Ausführung: Zylinderschaft mit Kühlkanal
und Rechtsspiralnuten

Solid carbide thread milling cutters
for internal threads

ISO metric thread DIN 13

Specification: Straight shank with internal coolant
and right hand spiral flutes

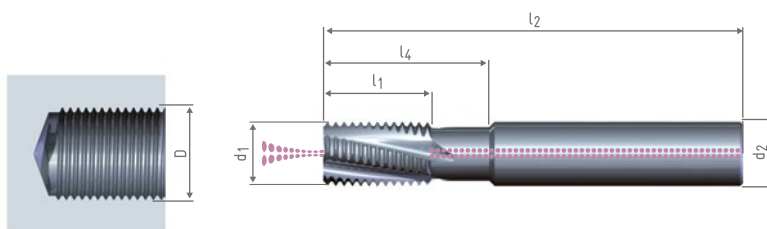

→HA (Zyl.-Schaft nach DIN 6535, Straight shank according to DIN 6535)

ORDER-CODE → GFM M →								T		F			
d ₁ Fräser Nenn-Ø Cutter nom. Ø	P mm	D ≥ für Gew.-Ø for thread Ø	l ₁	l ₂	d ₂	l ₄ Nutz- länge use length	z Nuten- zahl No. of flutes	blank uncoated	TiCN	TiAlN			
								Art.-Nr.	€	Art.-Nr.	€	Art.-Nr.	€
6	0,5	8	12	54	6	12	4	308844	138,00	308845	159,00	308846	159,00
6	1	8	12	54	6	12	4	308847	129,00	308848	150,00	308849	150,00
8	0,5	10	16	64	8	16	4	300257	173,00	301154	194,00	300284	194,00
8	0,75	10	16	64	8	16	4	300267	170,00	301155	191,00	300285	191,00
8	1	10	16	64	8	16	4	305531	149,00	308842	170,00	308843	170,00
10	0,75	12	16	70	10	25	4	300268	219,00	301156	240,00	300286	240,00
10	1	12	16	70	10	25	4	300269	186,00	301157	205,00	300287	205,00
10	1,25	14	16	70	10	25	4	300274	199,00	301158	220,00	300288	220,00
10	1,5	14	16	70	10	25	4	300270	176,00	301267	194,00	300289	194,00
12	0,5	14	20	80	12	31	4	300271	272,00	301159	298,00	300290	298,00
12	0,75	14	20	80	12	31	4	300627	272,00	301160	298,00	300674	298,00
12	1	16	20	80	12	31	4	300272	226,00	300842	249,00	300291	249,00
12	1,25	16	20	80	12	31	4	300273	248,00	301161	274,00	300292	274,00
12	1,5	16	20	80	12	31	4	300275	224,00	300453	250,00	300293	250,00
12	2	16	20	80	12	31	4	300276	234,00	301162	260,00	300294	260,00
16	1	20	25	90	16	40	5	300277	316,00	301163	347,00	300295	347,00
16	1,5	22	25	90	16	40	5	300278	281,00	301146	312,00	300296	312,00
16	2	22	25	90	16	40	5	300279	291,00	301200	322,00	300297	322,00
16	2,5	22	25	90	16	40	5	300280	316,00	301164	347,00	300298	347,00
18	3	24	33	102	18	50	5	311001	360,00	311003	396,00	311005	396,00
20	1	24	33	105	20	50	5	300235	435,00	301165	470,00	300299	470,00
20	1,5	26	33	105	20	50	5	300281	399,00	301166	434,00	300300	434,00
20	2	27	33	105	20	50	5	300282	408,00	301136	443,00	300301	443,00
20	2,5	30	33	105	20	50	5	300283	423,00	301167	458,00	300302	458,00
20	3	30	33	105	20	50	5	300234	423,00	301168	458,00	300303	458,00
20	3,5	30	33	105	20	50	5	300644	423,00	301169	458,00	300749	458,00
20	4	36	33	105	20	50	5	311002	443,00	311004	479,00	311006	479,00

Beachten Sie den kleinsten fräsbaren Gewindedurchmesser D ≥

Caution - please look at the smallest thread diameter D ≥
for the GFM tool system

→ HB

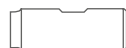

→ HE



Zyl.-Schaft nach DIN 6535 HB oder HE, kein Zuschlag, keine Rücknahme möglich
Straight shank according to DIN 6535 HB or HE, no extra charge, no withdrawal possible



GFM

Vollhartmetall-Gewindefräser für Außengewinde

Metrisches ISO-Gewinde DIN 13

Ausführung: Zylinderschaft mit Kühlkanal und Rechtsspiralnuten

Solid carbide thread milling cutters for external threads

ISO metric thread DIN 13

Specification: Straight shank with internal coolant and right hand spiral flutes

M

MF

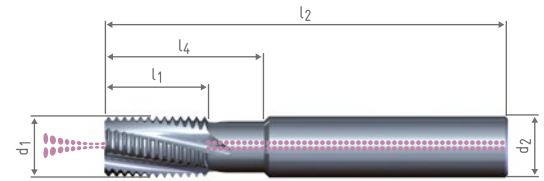
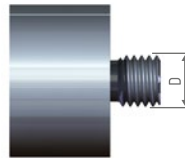
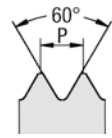

→HA (Zyl.-Schaft nach DIN 6535, Straight shank according to DIN 6535)

ORDER-CODE → GFM A M →								T		F			
d ₁ Fräser Nenn-Ø Cutter nom. Ø	P mm	D _≥ für Gew.-Ø for thread Ø	l ₁	l ₂	d ₂	l ₄ Nutz- länge use length	z Nuten- zahl No. of flutes	blank uncoated	TiCN	TiAlN			
								Art.-Nr.	€	Art.-Nr.	€	Art.-Nr.	€
8	0,8	5	16	64	8	16	4	307425	255,00	308854	279,00	308855	279,00
10	0,5	3	16	70	10	25	4	300648	305,00	310415	334,00	300955	334,00
10	0,75	5	16	70	10	25	4	300649	305,00	304502	334,00	303748	334,00
10	1,25	8	16	70	10	25	4	301011	263,00	301375	288,00	303756	288,00
12	1	6	20	80	12	31	4	300480	298,00	301284	328,00	300971	328,00
12	1,5	10	20	80	12	31	4	300482	270,00	301358	300,00	303769	300,00
12	2	14	20	80	12	31	4	300481	281,00	311007	311,00	303777	311,00
16	1,5	10	25	90	16	40	5	300633	337,00	301393	368,00	302035	368,00
16	2	14	25	90	16	40	5	301014	347,00	301350	378,00	303789	378,00
16	2,5	18	25	90	16	40	5	301015	372,00	311008	403,00	303797	403,00
20	3	24	33	105	20	50	5	301016	479,00	311009	514,00	303805	514,00

Beachten Sie den kleinsten fräsbaren Gewindedurchmesser D_≥

Caution - please look at the smallest thread diameter D_≥ for the GFM tool system

→ HB



→ HE



Zyl.-Schaft nach DIN 6535 HB oder HE, kein Zuschlag, keine Rücknahme möglich
Straight shank according to DIN 6535 HB or HE, no extra charge, no withdrawal possible

GFH

Vollhartmetall-Gewindefräser für Innengewinde

Metrisches ISO-Gewinde DIN 13

Ausführung: 1,5 x D bzw. 2 x D
Für vergütete und gehärtete Stähle 54-63 HRC
Zylinderschaft und gerade genutet

Solid carbide thread milling cutters for internal threads

ISO metric thread DIN 13
Specification: 1.5 x D resp. 2 x D
For tempered and hardened steels 54-63 HRC
Straight shank and straight flutes

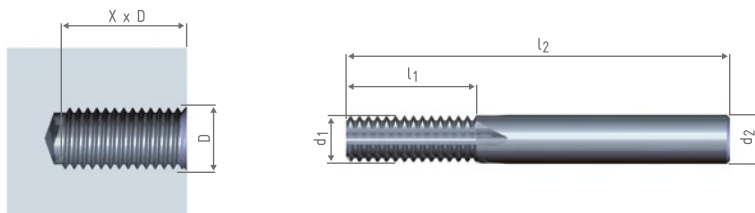
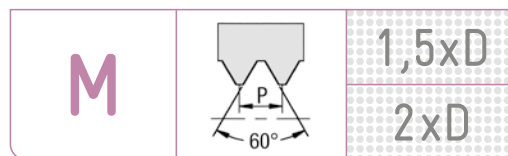

→HA (Zyl.-Schaft nach DIN 6535, Straight shank according to DIN 6535)

ORDER-CODE → GFH							→ 1,5 x D	
D	P mm	l ₁	l ₂	d ₂	Z Nuten- zahl No. of flutes	beschichtet coated	Art.-Nr.	€
M 4	0,7	7,30	48	6	4		304989	176,00
M 5	0,8	9,20	54	6	4		301290	180,00
M 6	1	10,50	64	8	4		301205	186,00
M 8	1,25	13,10	64	8	5		301292	204,00
M 10	1,5	17,20	80	10	5		301294	228,00
M 12	1,75	21,80	80	12	5		301203	246,00

ORDER-CODE → GFH							→ 2 x D	
D	P mm	l ₁	l ₂	d ₂	Z Nuten- zahl No. of flutes	beschichtet coated	Art.-Nr.	€
M 4	0,7	8,75	48	6	4		310007	176,00
M 5	0,8	10,75	54	6	4		301291	180,00
M 6	1	13,50	64	8	4		301206	186,00
M 8	1,25	18,10	64	8	5		301293	204,00
M 10	1,5	21,70	80	10	5		301295	228,00
M 12	1,75	25,30	80	12	5		301204	246,00



Zyl.-Schaft nach DIN 6535 HB oder HE, kein Zuschlag, keine Rücknahme möglich
Straight shank according to DIN 6535 HB or HE, no extra charge, no withdrawal possible



GFT-H

Vollhartmetall-Dreiprofilgewindefräser für Innengewinde

Metrisches ISO-Gewinde DIN 13

Ausführung: 2 x D, Gleichlaufräsen
Für vergütete und gehärtete Stähle 54-63 HRC
Zylinderschaft, rechtsschneidend und geradgenutet

Solid carbide thread milling cutters with three rings of teeth for internal threads

ISO metric thread DIN 13
Specification: 2 x D, climb milling
For tempered and hardened steels 54-63 HRC
Straight shank, right hand cutting straight flutes

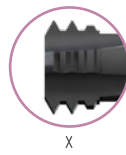

M

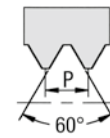

2xD

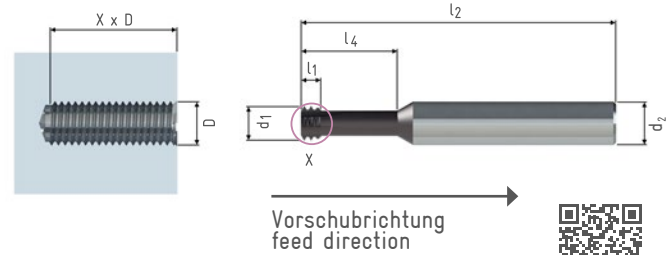

→ HA (Zyl.-Schaft nach DIN 6535, Straight shank according to DIN 6535)

ORDER-CODE → GFT-H →							2 x D	
D	P mm	l ₁	l ₂	l ₄ Nutz- länge use length	d ₂	z Nuten- zahl No. of flutes	ALTiSiN	
↓							Art.-Nr.	€
M 2	0,4	1,20	58	4,4	6	4	312688	125,00
M 2,5	0,45	1,35	58	5,5	6	4	312689	125,00
M 3	0,5	1,50	58	6,6	6	4	312690	125,00
M 3,5	0,6	1,80	58	7,7	6	4	312691	125,00
M 4	0,7	2,10	58	8,8	6	4	312692	125,00
M 5	0,8	2,40	58	11,0	6	4	312693	125,00
M 6	1	3,00	58	13,2	6	4	312694	125,00
M 8	1,25	3,75	62	17,5	8	4	312695	125,00

→ HB



→ HE



Zyl.-Schaft nach DIN 6535 HB oder HE, kein Zuschlag, keine Rücknahme möglich
Straight shank according to DIN 6535 HB or HE, no extra charge, no withdrawal possible

GFE

Vollhartmetall-Einprofilgewindefräser für Innengewinde

Metrisches ISO-Gewinde DIN 13

Ausführung: 2 x D bzw. 3 x D

Solid carbide thread milling cutters with single ring of teeth for internal threads

ISO metric thread DIN 13

Specification: 2 x D resp. 3 x D

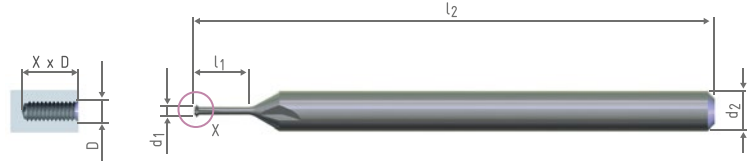
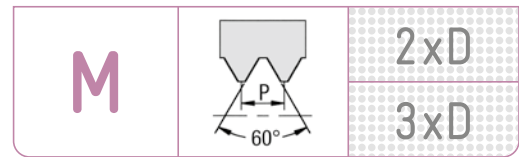
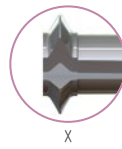

→HA (Zyl.-Schaft nach DIN 6535, Straight shank according to DIN 6535)

ORDER-CODE → GFE								2 x D		2 x D T	
D	P mm	Bereich range	l ₁	l ₂	d ₂	z Nuten- zahl No. of flutes	blank uncoated	TiCN			
↓											
							Art.-Nr.	€	Art.-Nr.	€	
M 1	0,25	M 1 - M 1,1	2,3	39	3	3	305187	65,00	305253	70,00	
M 1,2	0,25		2,5	39	3	3	305233	65,00	305252	70,00	
M 1,4	0,3		2,9	39	3	3	305234	65,00	305251	70,00	
M 1,6	0,35	M 1,6 - M 1,7	3,5	39	3	3	305235	65,00	305250	70,00	
M 1,8	0,35		3,7	39	3	3	305236	65,00	305249	70,00	
M 2	0,4		4,1	39	3	4	305237	65,00	305248	70,00	
M 2,2	0,45		4,5	39	3	4	305238	65,00	305247	70,00	
M 2,3	0,4		4,7	39	3	4	305239	65,00	305246	70,00	
M 2,5	0,45	M 2,5 - M 2,6	5,3	39	3	4	305240	65,00	305245	70,00	
M 3	0,5		6,2	39	3	4	305241	65,00	305244	70,00	
M 3,5	0,6		7,2	39	3	4	305242	65,00	305243	70,00	

ORDER-CODE → GFE								3 x D		3 x D T	
D	P mm	Bereich range	l ₁	l ₂	d ₂	z Nuten- zahl No. of flutes	blank uncoated	TiCN			
↓											
							Art.-Nr.	€	Art.-Nr.	€	
M 1	0,25	M 1 - M 1,1	3,4	39	3	3	305222	65,00	305215	70,00	
M 1,2	0,25		3,7	39	3	3	305223	65,00	305216	70,00	
M 1,4	0,3		4,3	39	3	3	305224	65,00	305127	70,00	
M 1,6	0,35	M 1,6 - M 1,7	5,2	39	3	3	305225	65,00	305128	70,00	
M 1,8	0,35		5,5	39	3	3	305226	65,00	305217	70,00	
M 2	0,4		6,1	39	3	4	305227	65,00	305129	70,00	
M 2,2	0,45		6,7	39	3	4	305228	65,00	305218	70,00	
M 2,3	0,4		7,0	39	3	4	305229	65,00	305219	70,00	
M 2,5	0,45	M 2,5 - M 2,6	7,9	39	3	4	305230	65,00	305220	70,00	
M 3	0,5		9,2	39	3	4	305231	65,00	305130	70,00	
M 3,5	0,6		10,7	39	3	4	305232	65,00	305221	70,00	



GFT SHARK

Vollhartmetall-Dreiprofilgewindefräser für Innengewinde

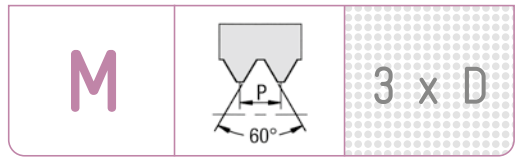

Metrisches ISO-Gewinde DIN 13 und metrisches ISO-Feingewinde DIN 13 ab Regelgewindedurchmesser

Ausführung: 3 x D, 3 volle Gewindeprofile
Zylinderschaft, ≥M4 mit Kühlkanal, Linksspiralnuten, rechtsschneidend

Solid carbide thread milling cutters with three rings of teeth for internal threads

ISO metric thread DIN 13 and metric ISO fine thread DIN 13 from standard thread diameter

Specification: 3 x D, 3 complete thread profiles

Straight shank, ≥M4 with internal coolant, left hand spiral flutes, right hand cutting

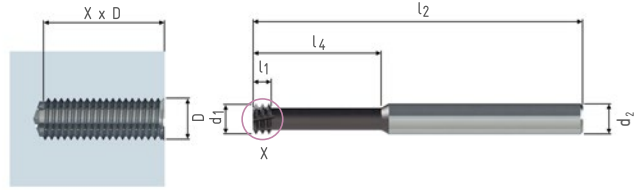

→HA (Zyl.-Schaft nach DIN 6535, Straight shank according to DIN 6535)

ORDER-CODE → GFT SHARK →							3 x D		
D	P mm	l ₁	l ₂	l ₄ Nutzlänge use length	d ₂	Z Nutenzahl No. of flutes	ALTiCrN	Art.-Nr.	€
M 1,2	0,25	0,75	39	3,9	3	4		312633	104,00
M 1,4	0,3	0,90	39	4,5	3	4		312635	104,00
M 1,6	0,35	1,05	39	5,2	3	4		312637	93,00
M 1,8	0,35	1,05	39	5,8	3	4		312639	104,00
M 2	0,4	1,20	39	6,4	3	4		312641	93,00
M 2,2	0,45	1,35	39	7,1	3	4		312643	104,00
M 2,5	0,45	1,35	39	8,0	3	4		312645	93,00
M 3	0,5	1,50	39	9,5	3	4		312647	93,00
M 3,5	0,6	1,80	39	11,1	3	6		312649	104,00

ORDER-CODE → GFT SHARK →							3 x D K		
D	P mm	l ₁	l ₂	l ₄ Nutzlänge use length	d ₂	Z Nutenzahl No. of flutes	ALTiCrN	Art.-Nr.	€
M 4	0,7	2,10	54	12,7	6	6		312651	110,00
M 5	0,8	2,40	54	15,8	6	6		312653	110,00
M 6	1	3,00	54	19,0	6	6		312655	110,00
M 8	1,25	3,75	68	25,4	8	6		312657	110,00
M 10	1,5	4,50	75	31,7	10	6		312659	142,00
M 12	1,75	5,25	82	38,0	10	6		312662	176,00
M 14/16	2	6,00	100	50,0	12	6		312664	199,00
M 18/20	2,5	7,50	115	62,0	16	6		312666	276,00



Zyl.-Schaft nach DIN 6535 HB oder HE, kein Zuschlag, keine Rücknahme möglich
Straight shank according to DIN 6535 HB or HE, no extra charge, no withdrawal possible



BGF

Vollhartmetall-Bohrungwindefräser für Innengewinde

Metrisches ISO-Gewinde DIN 13

Ausführung: 1,5 x D, 45° Senkfase, Zylinderschaft und Rechtsspiralnuten

Solid carbide drill thread milling cutters for internal threads

ISO metric thread DIN 13

Specification: 1.5 x D, 45° chamfer for countersinking, straight shank and right hand spiral flutes

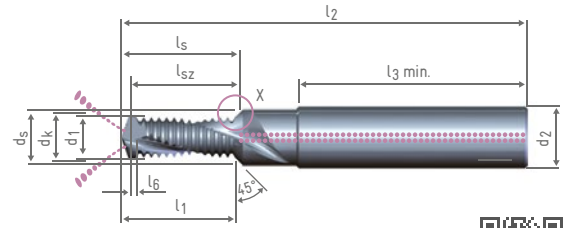
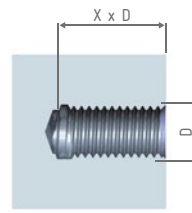
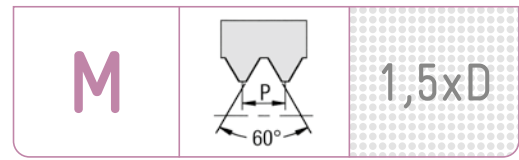
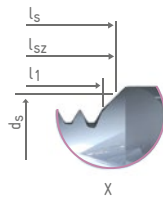

→HA (Zyl.-Schaft nach DIN 6535, Straight shank according to DIN 6535)

ORDER-CODE → BGF												1,5 x D		1,5 x D T		1,5 x D F	
D	P mm	l ₁	l ₂	l _{3 min.}	d ₂	d _s	l _s	l _{sz}	d _k	l ₆	z Nuten- zahl No. of flutes	blank uncoated		TiCN		TiAlN	
↓																	
												Art.-Nr.	€	Art.-Nr.	€	Art.-Nr.	€
M 3	0,5	5,40	48	36	6	3,2	5,9	5,4	2,50	0,5	2	400058	206,00	401013	221,00	400059	221,00
M 4	0,7	6,85	48	36	6	4,2	7,4	6,8	3,30	0,7	2	400025	179,00	401014	196,00	400061	196,00
M 5	0,8	8,70	54	36	6	5,3	9,4	8,6	4,20	0,8	2	400000	174,00	400435	192,00	400004	192,00
M 6	1	10,85	62	36	8	6,3	11,6	10,7	5,00	1	2	400001	169,00	400494	186,00	400021	186,00
M 8	1,25	13,65	74	40	10	8,4	14,6	13,4	6,75	1,25	2	400002	210,00	400495	235,00	400695	235,00
M 10	1,5	17,95	80	45	12	10,5	19,2	17,7	8,50	1,5	2	400003	253,00	400496	279,00	400694	279,00
M 12	1,75	20,75	90	45	14	12,6	22,2	20,3	10,25	1,5	2	400024	358,00	400497	385,00	400703	385,00

ORDER-CODE → BGF												1,5 x D K		1,5 x D KT		1,5 x D KF	
D	P mm	l ₁	l ₂	l _{3 min.}	d ₂	d _s	l _s	l _{sz}	d _k	l ₆	z Nuten- zahl No. of flutes	blank uncoated		TiCN		TiAlN	
↓																	
												Art.-Nr.	€	Art.-Nr.	€	Art.-Nr.	€
M 4	0,7	6,65	48	36	6	4,2	7,2	6,6	3,30	0,5	2	400364	238,00	400448	255,00	400377	255,00
M 5	0,8	8,70	54	36	6	5,3	9,4	8,6	4,20	0,8	2	400366	233,00	400449	251,00	410006	251,00
M 6	1	10,85	62	36	8	6,3	11,6	10,7	5,00	1,0	2	400026	227,00	400450	247,00	400075	247,00
M 8	1,25	13,65	74	40	10	8,4	14,6	13,4	6,75	1,25	2	400029	272,00	400451	298,00	400072	298,00
M 10	1,5	17,95	80	45	12	10,5	19,2	17,7	8,50	1,5	2	400030	319,00	400452	345,00	400070	345,00
M 12	1,75	20,75	90	45	14	12,6	22,2	20,3	10,25	1,5	2	400038	415,00	400453	442,00	400197	442,00
M 14	2	23,55	102	48	16	14,7	25,2	23,0	12,00	1,5	2	400031	533,00	401021	563,00	400316	563,00
M 16	2	25,90	102	48	18	16,8	27,6	25,1	14,00	1,5	2	400084	605,00	400398	635,00	400317	635,00

→ HB



→ HE



Zyl.-Schaft nach DIN 6535 HB oder HE, kein Zuschlag, keine Rücknahme möglich
Straight shank according to DIN 6535 HB or HE, no extra charge, no withdrawal possible

→ K

Kühlkanal
internal coolant



M
MF
MJ
EG M

G
Rc, R
Pg

UNC
UNF
UN
UNJF

NPT
NPTF

M
MF
M keg.
M taper

G
BSW
BSF
DIN 477
R, BA, Pg

UNC
UNF
UNEF
UN, UNS

NPSM
NPT
NPTF
Tr, Rd

M
MF

G
BSW
BSF
R, Pg
MF-EL

UNC, UNF
UNEF
UN, UNS
UNJC
UNJF

NPT
NPTF
Tr
EG

BGF

Vollhartmetall-Bohrungweidfräser für Innengewinde

Metrisches ISO-Gewinde DIN 13

Ausführung: 2 x D, 45° Senkfase, Zylinderschaft und Rechtsspiralnuten

Solid carbide drill thread milling cutters for internal threads

ISO metric thread DIN 13

Specification: 2 x D, 45° chamfer for countersinking, straight shank and right hand spiral flutes

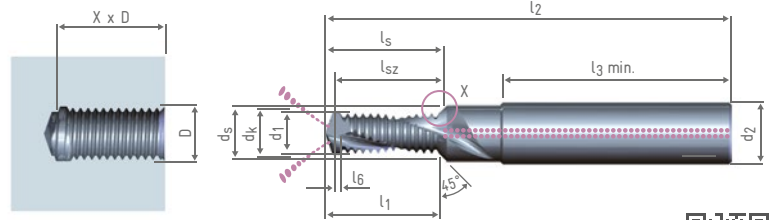
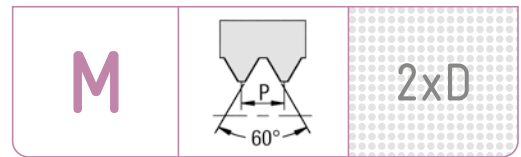
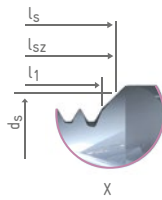

→ HA (Zyl.-Schaft nach DIN 6535, Straight shank according to DIN 6535)

ORDER-CODE → BGF												2 x D		2 x D T		2 x D F	
D	P mm	l ₁	l ₂	l _{3 min.}	d ₂	d _s	l _s	l _{sz}	d _k	l ₆	z Nuten- zahl No. of flutes	blank uncoated		TiCN		TiAlN	
												Art.-Nr.	€	Art.-Nr.	€	Art.-Nr.	€
M 3	0,5	6,90	48	36	6	3,2	7,4	6,9	2,50	0,5	2	400005	206,00	400485	221,00	400060	221,00
M 4	0,7	8,95	48	36	6	4,2	9,5	8,9	3,30	0,7	2	400006	179,00	401017	196,00	400062	196,00
M 5	0,8	11,10	54	36	6	5,3	11,8	11,0	4,20	0,8	2	400007	174,00	401018	192,00	400023	192,00
M 6	1	13,85	62	36	8	6,3	14,6	13,7	5,00	1,0	2	400010	169,00	400498	186,00	400696	186,00
M 8	1,25	18,65	74	40	10	8,4	19,6	18,4	6,75	1,25	2	400011	210,00	400499	235,00	400022	235,00
M 10	1,5	22,45	80	45	12	10,5	23,7	22,2	8,50	1,5	2	400014	253,00	400500	279,00	400697	279,00
M 12	1,75	26,00	90	45	14	12,6	27,4	25,5	10,25	1,5	2	400015	358,00	400501	385,00	400127	385,00
M 16	2	35,90	102	48	18	16,8	37,6	35,1	14,00	1,5	2	400019	532,00	401020	563,00	400068	563,00

ORDER-CODE → BGF												2 x D K		2 x D KT		2 x D KF	
D	P mm	l ₁	l ₂	l _{3 min.}	d ₂	d _s	l _s	l _{sz}	d _k	l ₆	z Nuten- zahl No. of flutes	blank uncoated		TiCN		TiAlN	
												Art.-Nr.	€	Art.-Nr.	€	Art.-Nr.	€
M 4	0,7	8,75	48	36	6	4,2	9,3	8,7	3,30	0,5	2	400365	238,00	400455	255,00	400581	255,00
M 5	0,8	11,10	54	36	6	5,3	11,8	11,0	4,20	0,8	2	400008	233,00	400456	251,00	400378	251,00
M 6	1	13,85	62	36	8	6,3	14,6	13,7	5,00	1,0	2	400009	227,00	400457	247,00	400074	247,00
M 8	1,25	18,65	74	40	10	8,4	19,6	18,4	6,75	1,25	2	400012	272,00	400423	298,00	400073	298,00
M 10	1,5	22,45	80	45	12	10,5	23,7	22,2	8,50	1,5	2	400013	319,00	400458	345,00	400071	345,00
M 12	1,75	26,00	90	45	14	12,6	27,4	25,5	10,25	1,5	2	400016	415,00	400459	442,00	400035	442,00
M 14	2	31,55	102	48	16	14,7	33,2	31,0	12,00	1,5	2	400017	533,00	401022	563,00	400319	563,00
M 16	2	35,90	102	48	18	16,8	37,6	35,1	14,00	1,5	2	400020	605,00	400397	635,00	400706	635,00

→ HB

→ HE

Zyl.-Schaft nach DIN 6535 HB oder HE, kein Zuschlag, keine Rücknahme möglich
Straight shank according to DIN 6535 HB or HE, no extra charge, no withdrawal possible

→ K Kühlkanal
internal coolant

BGF

Vollhartmetall-Bohrungwindefräser für Innengewinde

Metrisches ISO-Gewinde DIN 13

Ausführung: 2,5 x D, 45° Senkfase, Zylinderschaft und Rechtsspiralnuten

Solid carbide drill thread milling cutters for internal threads

ISO metric thread DIN 13

Specification: 2.5 x D, 45° chamfer for countersinking, straight shank and right hand spiral flutes

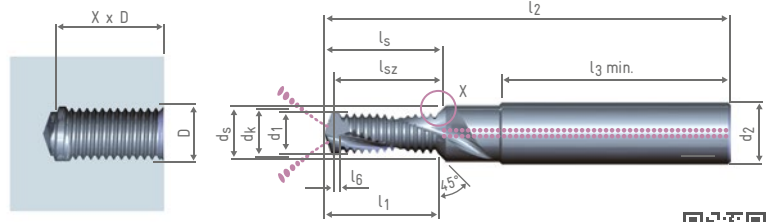
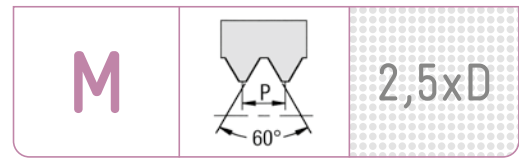
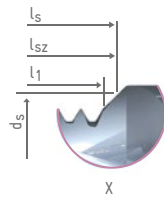

→HA (Zyl.-Schaft nach DIN 6535, Straight shank according to DIN 6535)

ORDER-CODE → BGF												2,5 x D	2,5 x D T	2,5 x D F			
D	P mm	l ₁	l ₂	l _{3 min.}	d ₂	d _s	l _s	l _{sz}	d _k	l ₆	z Nuten- zahl No. of flutes	blank uncoated	TiCN	TiAlN			
↓																	
												Art.-Nr.	€	Art.-Nr.	€	Art.-Nr.	€
M 3	0,5	8,40	48	36	6	3,2	8,9	8,4	2,50	0,5	2	400266	216,00	410013	232,00	410033	232,00
M 4	0,7	11,05	54	36	6	4,2	11,6	11,0	3,30	0,7	2	400227	189,00	410014	206,00	410035	206,00
M 5	0,8	13,50	54	36	6	5,3	14,2	13,4	4,20	0,8	2	400046	183,00	410016	202,00	400530	202,00
M 6	1	16,85	62	36	8	6,3	17,6	16,7	5,00	1,0	2	400050	177,00	401037	195,00	400776	195,00
M 8	1,25	22,40	74	40	10	8,4	23,4	22,2	6,75	1,25	2	400102	220,00	410017	247,00	400444	247,00
M 10	1,5	26,95	80	45	12	10,5	28,2	26,7	8,50	1,5	2	400109	266,00	400597	294,00	401058	294,00
M 12	1,75	31,25	90	45	14	12,6	32,7	30,8	10,25	1,5	2	400595	376,00	410030	405,00	410039	405,00

ORDER-CODE → BGF												2,5 x D K	2,5 x D KT	2,5 x D KF			
D	P mm	l ₁	l ₂	l _{3 min.}	d ₂	d _s	l _s	l _{sz}	d _k	l ₆	z Nuten- zahl No. of flutes	blank uncoated	TiCN	TiAlN			
↓																	
												Art.-Nr.	€	Art.-Nr.	€	Art.-Nr.	€
M 4	0,7	10,85	54	36	6	4,2	11,4	10,8	3,30	0,5	2	400395	250,00	410042	268,00	400676	268,00
M 5	0,8	13,50	54	36	6	5,3	14,2	13,4	4,20	0,8	2	400393	245,00	410044	264,00	400974	264,00
M 6	1	16,85	62	36	8	6,3	17,6	16,7	5,00	1,0	2	400077	239,00	400598	258,00	400307	258,00
M 8	1,25	22,40	74	40	10	8,4	23,4	22,2	6,75	1,25	2	400100	285,00	400491	313,00	400200	313,00
M 10	1,5	26,95	80	45	12	10,5	28,2	26,7	8,50	1,5	2	400110	335,00	400596	363,00	400420	363,00
M 12	1,75	31,25	90	45	14	12,6	32,7	30,8	10,25	1,5	2	400376	436,00	401036	465,00	400791	465,00
M 14	2	39,55	102	48	16	14,7	41,2	39,0	12,00	1,5	2	410040	560,00	410046	591,00	410050	591,00
M 16	2	45,90	102	48	18	16,8	47,6	45,1	14,00	1,5	2	401057	636,00	410047	667,00	401056	667,00

→ HB



→ HE



Zyl.-Schaft nach DIN 6535 HB oder HE, kein Zuschlag, keine Rücknahme möglich
Straight shank according to DIN 6535 HB or HE, no extra charge, no withdrawal possible

→ K

Kühlkanal
internal coolant



M
MF
MJ
EG M

G
Rc, R
Pg

UNC
UNF
UN
UNJF

NPT
NPTF

M
MF
M keg.
M taper

G
BSW
BSF
DIN 477
R, BA, Pg

UNC
UNF
UNEF
UN, UNS

NPSM
NPT
NPTF
Tr, Rd

M
MF

G
BSW
BSF
R, Pg
MF-EL

UNC, UNF
UNEF
UN, UNS
UNJC
UNJF

NPT
NPTF
Tr
EG

BGF 3

Vollhartmetall-Bohrungweidfräser für Innengewinde

Metrisches ISO-Gewinde DIN 13

Ausführung: Z = 3, 1,5 x D, 45° Senkfase, Zylinderschaft und Rechtsspiralnuten

Solid carbide drill thread milling cutters for internal threads

ISO metric thread DIN 13

Specification: Z = 3, 1,5 x D, 45° chamfer for counter-sinking, straight shank and right hand spiral flutes

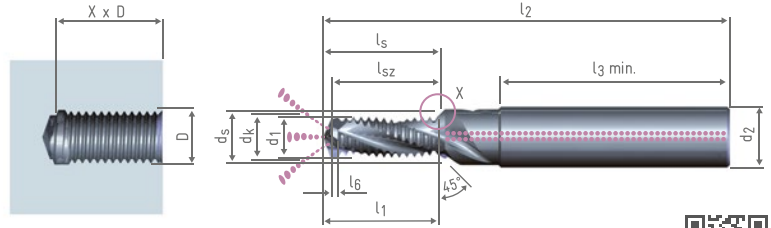
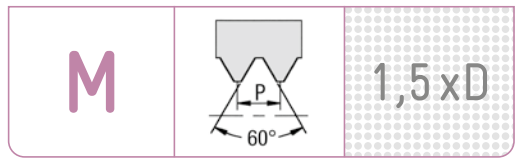
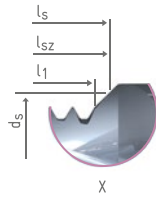

→ HA (Zyl.-Schaft nach DIN 6535, Straight shank according to DIN 6535)

ORDER-CODE → BGF 3													1,5 x D		1,5 x D T		1,5 x D F	
D	P mm	l ₁	l ₂	l _{3 min.}	d ₂	d _s	l _s	l _{sz}	d _k	l ₆	z Nuten- zahl No. of flutes	blank uncoated		TiCN		TiAlN		
												Art.-Nr.	€	Art.-Nr.	€	Art.-Nr.	€	
M 3	0,5	5,40	48	36	6	3,2	5,9	5,4	2,50	0,5	3	410189	247,00	410191	265,00	410197	265,00	
M 4	0,7	6,65	48	36	6	4,2	7,2	6,6	3,30	0,5	3	400674	216,00	410190	235,00	410196	235,00	
M 5	0,8	8,70	54	36	6	5,3	9,4	8,6	4,20	0,8	3	400438	210,00	400436	230,00	400513	230,00	
M 6	1	10,85	62	36	8	6,3	11,6	10,7	5,00	1,0	3	401091	202,00	401089	222,00	410195	222,00	
M 8	1,25	13,65	74	40	10	8,4	14,6	13,4	6,75	1,25	3	400231	252,00	410192	282,00	400265	282,00	
M 10	1,5	17,95	80	45	12	10,5	19,2	17,7	8,50	1,5	3	400239	304,00	410193	335,00	410194	335,00	

ORDER-CODE → BGF 3													1,5 x D K		1,5 x D KT		1,5 x D KF	
D	P mm	l ₁	l ₂	l _{3 min.}	d ₂	d _s	l _s	l _{sz}	d _k	l ₆	z Nuten- zahl No. of flutes	blank uncoated		TiCN		TiAlN		
												Art.-Nr.	€	Art.-Nr.	€	Art.-Nr.	€	
M 6	1	10,85	62	36	8	6,3	11,6	10,7	5,00	1,0	3	400179	272,00	401088	299,00	410200	299,00	
M 8	1,25	13,65	74	40	10	8,4	14,6	13,4	6,75	1,25	3	400148	325,00	400651	358,00	400964	358,00	
M 10	1,5	17,95	80	45	12	10,5	19,2	17,7	8,50	1,5	3	400168	382,00	400652	414,00	400373	414,00	
M 12	1,75	20,75	90	45	14	12,6	22,2	20,3	10,25	1,5	3	400171	498,00	410199	530,00	400778	530,00	
M 14	2	23,55	102	48	16	14,7	25,2	23,0	12,00	1,5	3	400310	640,00	410198	675,00	410201	675,00	
M 16	2	25,90	102	48	18	16,8	27,6	25,1	14,00	1,5	3	400340	725,00	400400	762,00	410202	762,00	

→ HB



→ HE

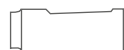

Zyl.-Schaft nach DIN 6535 HB oder HE, kein Zuschlag, keine Rücknahme möglich
Straight shank according to DIN 6535 HB or HE, no extra charge, no withdrawal possible

→ K

Kühlkanal
internal coolant

BGF 3

Vollhartmetall-Bohrungweidfräser für Innengewinde

Metrisches ISO-Gewinde DIN 13

Ausführung: Z = 3, 2 x D, 45° Senkfase, Zylinderschaft und Rechtsspiralnuten

Solid carbide drill thread milling cutters for internal threads

ISO metric thread DIN 13

Specification: Z = 3, 2 x D, 45° chamfer for counter-sinking, straight shank and right hand spiral flutes

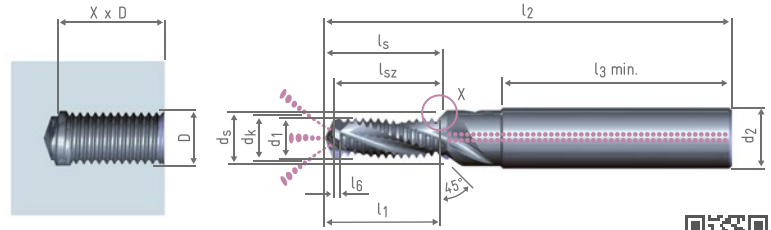
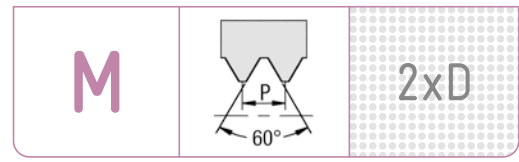
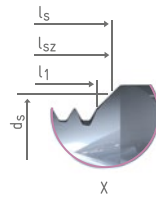

→HA (Zyl.-Schaft nach DIN 6535, Straight shank according to DIN 6535)

ORDER-CODE → BGF 3												2 x D		2 x D T		2 x D F	
D	P mm	l ₁	l ₂	l _{3 min.}	d ₂	d _s	l _s	l _{sz}	d _k	l ₆	z Nuten- zahl No. of flutes	blank uncoated		TiCN		TiAlN	
↓												Art.-Nr. €		Art.-Nr. €		Art.-Nr. €	
M 3	0,5	6,90	48	36	6	3,2	7,4	6,9	2,50	0,5	3	400603	247,00	411006	265,00	411010	265,00
M 4	0,7	8,75	48	36	6	4,2	9,3	8,7	3,30	0,5	3	400279	216,00	401084	235,00	411011	235,00
M 5	0,8	11,10	54	36	6	5,3	11,8	11,0	4,20	0,8	3	400281	210,00	411007	230,00	411012	230,00
M 6	1	13,85	62	36	8	6,3	14,6	13,7	5,00	1,0	3	400236	202,00	400437	222,00	411013	222,00
M 8	1,25	18,65	74	40	10	8,4	19,6	18,4	6,75	1,25	3	400234	252,00	411008	282,00	411014	282,00
M 10	1,5	22,45	80	45	12	10,5	23,7	22,2	8,50	1,5	3	400225	304,00	411009	335,00	400382	335,00
M 12	1,75	26,00	90	45	14	12,6	27,4	25,5	10,25	1,5	3	400232	429,00	400923	463,00	400375	463,00

ORDER-CODE → BGF 3												2 x D K		2 x D KT		2 x D KF	
D	P mm	l ₁	l ₂	l _{3 min.}	d ₂	d _s	l _s	l _{sz}	d _k	l ₆	z Nuten- zahl No. of flutes	blank uncoated		TiCN		TiAlN	
↓												Art.-Nr. €		Art.-Nr. €		Art.-Nr. €	
M 6	1	13,85	62	36	8	6,3	14,6	13,7	5,00	1,0	3	400178	272,00	400403	299,00	400260	299,00
M 8	1,25	18,65	74	40	10	8,4	19,6	18,4	6,75	1,25	3	400180	325,00	400402	358,00	400277	358,00
M 10	1,5	22,45	80	45	12	10,5	23,7	22,2	8,50	1,5	3	400167	382,00	400623	414,00	400226	414,00
M 12	1,75	26,00	90	45	14	12,6	27,4	25,5	10,25	1,5	3	400170	498,00	400624	530,00	400621	530,00
M 14	2	31,55	102	48	16	14,7	33,2	31,0	12,00	1,5	3	400311	640,00	411015	675,00	400622	675,00
M 16	2	35,90	102	48	18	16,8	37,6	35,1	14,00	1,5	3	400328	725,00	401113	762,00	400557	762,00

→ HB



→ HE



Zyl.-Schaft nach DIN 6535 HB oder HE, kein Zuschlag, keine Rücknahme möglich
Straight shank according to DIN 6535 HB or HE, no extra charge, no withdrawal possible

→ K

Kühlkanal
internal coolant



M
MF
MJ
EG M

G
Rc, R
Pg

UNC
UNF
UN
UNJF

NPT
NPTF

M
MF
M keg.
M taper

G
BSW
BSF
DIN 477
R, BA, Pg

UNC
UNF
UNEF
UN, UNS

NPSM
NPT
NPTF
Tr, Rd

M
MF

G
BSW
BSF
R, Pg
MF-EL

UNC, UNF
UNEF
UN, UNS
UNJC
UNJF

NPT
NPTF
Tr
EG

BGF 3

Vollhartmetall-Bohrungsschneidfräser für Innengewinde

Metrisches ISO-Gewinde DIN 13

Ausführung: Z = 3, 2,5 x D, 45° Senkfase, Zylinderschaft und Rechtsspiralnuten

Solid carbide drill thread milling cutters for internal threads

ISO metric thread DIN 13

Specification: Z = 3, 2,5 x D, 45° chamfer for counter-sinking, straight shank and right hand spiral flutes

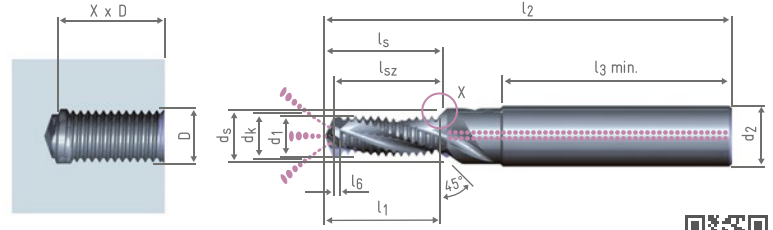
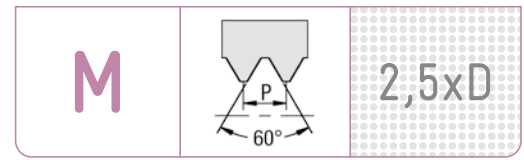
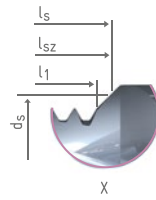

→ HA (Zyl.-Schaft nach DIN 6535, Straight shank according to DIN 6535)

ORDER-CODE → BGF 3												2,5 x D		2,5 x D T		2,5 x D F	
D	P mm	l ₁	l ₂	l _{3 min.}	d ₂	d _s	l _s	l _{sz}	d _k	l ₆	z Nuten- zahl No. of flutes	blank uncoated		TiCN		TiAlN	
												Art.-Nr.	€	Art.-Nr.	€	Art.-Nr.	€
M 3	0,5	8,40	48	36	6	3,2	8,9	8,4	2,50	0,5	3	400257	254,00	411016	273,00	411021	273,00
M 4	0,7	10,85	54	36	6	4,2	11,4	10,8	3,30	0,5	3	400203	222,00	411017	242,00	411022	242,00
M 5	0,8	13,50	54	36	6	5,3	14,2	13,4	4,20	0,8	3	400183	216,00	411018	237,00	411023	237,00
M 6	1	16,85	62	36	8	6,3	17,6	16,7	5,00	1,0	3	400187	208,00	401038	229,00	400271	229,00
M 8	1,25	22,40	74	40	10	8,4	23,4	22,2	6,75	1,25	3	400235	260,00	411019	290,00	411024	290,00
M 10	1,5	26,95	80	45	12	10,5	28,2	26,7	8,50	1,5	3	400199	313,00	411020	345,00	411025	345,00

ORDER-CODE → BGF 3												2,5 x D K		2,5 x D KT		2,5 x D KF	
D	P mm	l ₁	l ₂	l _{3 min.}	d ₂	d _s	l _s	l _{sz}	d _k	l ₆	z Nuten- zahl No. of flutes	blank uncoated		TiCN		TiAlN	
												Art.-Nr.	€	Art.-Nr.	€	Art.-Nr.	€
M 6	1	16,85	62	36	8	6,3	17,6	16,7	5,00	1,0	3	400177	280,00	400447	308,00	400284	308,00
M 8	1,25	22,40	74	40	10	8,4	23,4	22,2	6,75	1,25	3	400166	335,00	400431	369,00	400415	369,00
M 10	1,5	26,95	80	45	12	10,5	28,2	26,7	8,50	1,5	3	400169	393,00	400432	426,00	411027	426,00
M 12	1,75	31,25	90	45	14	12,6	32,7	30,8	10,25	1,5	3	400172	513,00	401001	546,00	400792	546,00
M 14	2	39,55	102	48	16	14,7	41,2	39,0	12,00	1,5	3	400554	659,00	411026	695,00	411028	695,00
M 16	2	45,90	102	48	18	16,8	47,6	45,1	14,00	1,5	3	400230	747,00	400629	785,00	411029	785,00

3 x D auf Anfrage

3 x D on request

→ HB



→ HE

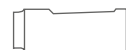

Zyl.-Schaft nach DIN 6535 HB oder HE, kein Zuschlag, keine Rücknahme möglich
Straight shank according to DIN 6535 HB or HE, no extra charge, no withdrawal possible

→ K

Kühlkanal
internal coolant

BGFS

Vollhartmetall-Zirkularbohrungswindefräser für Innengewinde

Metrisches ISO-Gewinde DIN 13

Ausführung: 2,5 x D

Zylinderschaft **linksschneidend** und gerade genutet

Solid carbide circular drill thread milling cutters for internal threads

ISO metric thread DIN 13

Specification: 2,5 x D

Straight shank, **left hand cutting** and straight flutes

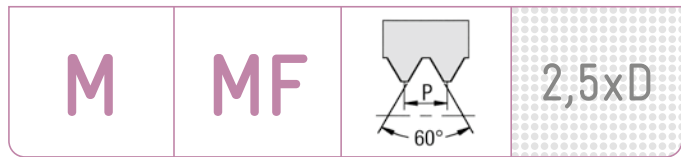
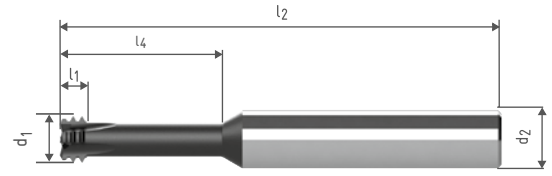
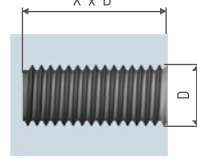

→HA (Zyl.-Schaft nach DIN 6535, Straight shank according to DIN 6535)

ORDER-CODE → BGFS									2,5 x D	
D	P mm	Bereich range	l ₁	l ₂	l ₄ Nutzlänge use length	d ₂	z Nutenzahl No. of flutes	ALTiSiN	Art.-Nr.	€
M 2	0,4	M 2 - M 2,5 x 0,4	1,20	58	5,8	6	4		412487	112,00
M 2,5	0,45	M 2,5 - M 3 x 0,45	1,35	58	7,2	6	4		412420	112,00
M 3	0,5	M 3 - M 4 x 0,5	1,50	58	8,2	6	4		412344	108,00
M 4	0,7	M 4 - M 5 x 0,7	2,10	58	11,2	6	4		412298	104,00
M 5	0,8	M 5 - M 6 x 0,8	2,40	58	13,7	6	4		412322	104,00
M 6	1	M 6 - M 8 x 1	3,00	58	17,6	6	4		412221	104,00
M 8	1,25	M 8 - M 10 x 1,25	3,75	62	22,0	8	4		412222	120,00
M 10	1,5	M 10 - M 12 x 1,5	4,50	76	27,5	10	4		412223	128,00
M 12	1,75	M 12 - M 14 x 1,75	5,25	76	32,8	10	4		412299	130,00
M 14	2	M 14 - M 16 x 2	6,00	88	38,2	12	4		412323	162,00
M 16	2	M 16 - M 18 x 2	6,00	92	43,2	14	4		412324	198,00
M 8	0,75	M 8x0,75 - M 10 x 0,75	2,25	62	22,0	8	4		412352	126,00
M 10	1	M 10x1 - M 12 x 1	3,00	76	27,5	10	4		412353	132,00

Preise für weitere Gewinde auf Anfrage

prices for further threads on request

→ HB



→ HE



Zyl.-Schaft nach DIN 6535 HB oder HE, kein Zuschlag, keine Rücknahme möglich
Straight shank according to DIN 6535 HB or HE, no extra charge, no withdrawal possible



BGF

Vollhartmetall-Bohrgewindefräser für Innengewinde

Metrisches ISO-Feingewinde DIN 13

Ausführung: 1,5 x D, 45° Senkfase, Zylinderschaft und Rechtsspiralnuten

Solid carbide drill thread milling cutters for internal threads

ISO metric fine thread DIN 13

Specification: 1.5 x D, 45° chamfer for countersinking, straight shank and right hand spiral flutes

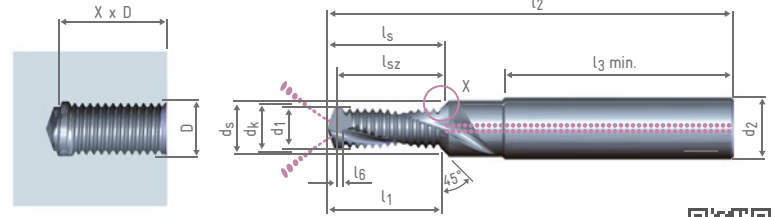
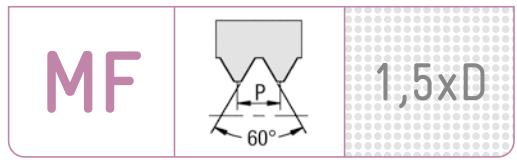
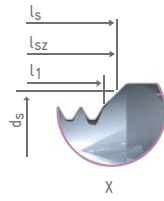

→ HA (Zyl.-Schaft nach DIN 6535, Straight shank according to DIN 6535)

ORDER-CODE → BGF												1,5 x D		1,5 x D T		1,5 x D F	
D	P mm	l ₁	l ₂	l _{3 min.}	d ₂	d _s	l _s	l _{sz}	d _k	l ₆	z Nuten- zahl No. of flutes	blank uncoated	TiCN	TiAlN			
↓	↓											Art.-Nr.	€	Art.-Nr.	€	Art.-Nr.	€
M 5	0,5	8,30	54	36	6	5,3	8,9	8,1	4,50	0,5	2	400251	214,00	410018	231,00	410020	231,00
M 6	0,75	9,90	62	36	8	6,3	10,6	9,6	5,25	0,75	2	400219	191,00	410019	217,00	410026	217,00
M 8	1	14,20	74	40	10	8,4	15,1	13,8	7,00	1,0	2	400028	231,00	410021	258,00	410027	258,00
M 10	1	16,55	80	45	12	10,5	17,6	16,0	9,00	1,0	2	400276	280,00	410022	308,00	410028	308,00
M 12	1	19,95	90	45	14	12,6	21,0	19,0	11,00	1,0	2	400132	385,00	410023	414,00	410029	414,00
M 10	1,25	16,50	80	45	12	10,5	17,6	16,0	8,75	1,25	2	400224	291,00	410024	319,00	410031	319,00
M 12	1,5	21,30	90	45	14	12,6	22,6	20,7	10,50	1,5	2	400091	385,00	410025	414,00	410032	414,00

ORDER-CODE → BGF												1,5 x D K		1,5 x D KT		1,5 x D KF	
D	P mm	l ₁	l ₂	l _{3 min.}	d ₂	d _s	l _s	l _{sz}	d _k	l ₆	z Nuten- zahl No. of flutes	blank uncoated	TiCN	TiAlN			
↓	↓											Art.-Nr.	€	Art.-Nr.	€	Art.-Nr.	€
M 6	0,75	9,90	62	36	8	6,3	10,6	9,6	5,25	0,75	2	400220	251,00	410034	276,00	410049	276,00
M 8	1	14,20	74	40	10	8,4	15,1	13,8	7,00	1,0	2	400027	294,00	400460	319,00	410051	319,00
M 10	1	16,55	80	45	12	10,5	17,6	16,0	9,00	1,0	2	400238	346,00	400461	373,00	410052	373,00
M 12	1	19,95	90	45	14	12,6	21,0	19,0	11,00	1,0	2	400136	442,00	410041	470,00	410053	470,00
M 10	1,25	16,50	80	45	12	10,5	17,6	16,0	8,75	1,25	2	400223	357,00	410043	384,00	410054	384,00
M 12	1,5	21,30	90	45	14	12,6	22,6	20,7	10,50	1,5	2	400090	442,00	400462	470,00	410055	470,00
M 14	1,5	23,20	102	48	16	14,7	24,9	22,6	12,50	1,5	2	400210	581,00	410045	611,00	400506	611,00
M 16	1,5	28,00	102	48	18	16,8	29,8	27,2	14,50	1,5	2	400065	654,00	400463	683,00	400980	683,00

→ HB



→ HE



Zyl.-Schaft nach DIN 6535 HB oder HE, kein Zuschlag, keine Rücknahme möglich
Straight shank according to DIN 6535 HB or HE, no extra charge, no withdrawal possible

→ K

Kühlkanal
internal coolant

BGF

Vollhartmetall-Bohrungwindefräser für Innengewinde

Metrisches ISO-Feingewinde DIN 13

Ausführung: 2 x D, 45° Senkfase, Zylinderschaft und Rechtspiralnuten

Solid carbide drill thread milling cutters for internal threads

ISO metric fine thread DIN 13

Specification: 2 x D, 45° chamfer for countersinking, straight shank and right hand spiral flutes

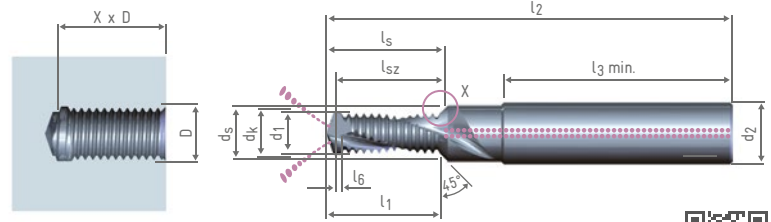
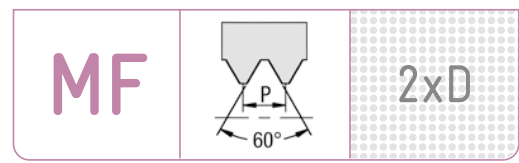
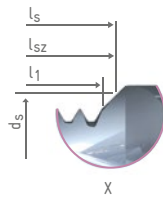

→HA (Zyl.-Schaft nach DIN 6535, Straight shank according to DIN 6535)

ORDER-CODE → BGF												2 x D	2 x D T	2 x D F			
D	P mm	l ₁	l ₂	l _{3 min.}	d ₂	d _s	l _s	l _{sz}	d _k	l ₆	z Nuten- zahl No. of flutes	blank uncoated	TiCN	TiAlN			
↓	↓																
												Art.-Nr.	€	Art.-Nr.	€	Art.-Nr.	€
M 5	0,5	10,80	54	36	6	5,3	11,4	10,6	4,50	0,5	2	400252	214,00	410036	231,00	410038	231,00
M 6	0,75	12,90	62	36	8	6,3	13,6	12,6	5,25	0,75	2	400217	191,00	410064	217,00	410073	217,00
M 8	1	17,20	74	40	10	8,4	18,1	16,8	7,00	1,0	2	400034	231,00	410065	258,00	410074	258,00
M 10	1	21,55	80	45	12	10,5	22,6	21,0	9,00	1,0	2	400188	280,00	410066	308,00	410075	308,00
M 12	1	25,95	90	45	14	12,6	27,0	25,0	11,00	1,0	2	400134	385,00	410067	414,00	410076	414,00
M 10	1,25	21,50	80	45	12	10,5	22,6	21,0	8,75	1,25	2	400222	291,00	410068	319,00	410077	319,00
M 12	1,5	27,30	90	45	14	12,6	28,6	26,7	10,50	1,5	2	400088	385,00	410069	414,00	400789	414,00

ORDER-CODE → BGF												2 x D K	2 x D KT	2 x D KF			
D	P mm	l ₁	l ₂	l _{3 min.}	d ₂	d _s	l _s	l _{sz}	d _k	l ₆	z Nuten- zahl No. of flutes	blank uncoated	TiCN	TiAlN			
↓	↓																
												Art.-Nr.	€	Art.-Nr.	€	Art.-Nr.	€
M 6	0,75	12,90	62	36	8	6,3	13,6	12,6	5,25	0,75	2	400218	251,00	410078	276,00	410091	276,00
M 8	1	17,20	74	40	10	8,4	18,1	16,8	7,00	1,0	2	400033	294,00	400464	319,00	410092	319,00
M 10	1	21,55	80	45	12	10,5	22,6	21,0	9,00	1,0	2	400237	346,00	400465	373,00	400518	373,00
M 12	1	25,95	90	45	14	12,6	27,0	25,0	11,00	1,0	2	400135	442,00	410088	470,00	400701	470,00
M 10	1,25	21,50	80	45	12	10,5	22,6	21,0	8,75	1,25	2	400221	357,00	410089	384,00	400405	384,00
M 12	1,5	27,30	90	45	14	12,6	28,6	26,7	10,50	1,5	2	400089	442,00	400466	470,00	410093	470,00
M 14	1,5	30,70	102	48	16	14,7	32,4	30,1	12,50	1,5	2	400208	581,00	410090	611,00	410094	611,00
M 16	1,5	34,00	102	48	18	16,8	35,8	33,2	14,50	1,5	2	400064	654,00	400467	683,00	400783	683,00

→ HB



→ HE

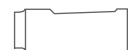

Zyl.-Schaft nach DIN 6535 HB oder HE, kein Zuschlag, keine Rücknahme möglich
Straight shank according to DIN 6535 HB or HE, no extra charge, no withdrawal possible

→ K

Kühlkanal
internal coolant



M
MF
MJ
EG M

G
Rc, R
Pg

UNC
UNF
UN
UNJF

NPT
NPTF

M
MF
M keg.
M taper

G
BSW
BSF
DIN 477
R, BA, Pg

UNC
UNF
UNEF
UN, UNS

NPSM
NPT
NPTF
Tr, Rd

M
MF

G
BSW
BSF
R, Pg
MF-EL

UNC, UNF
UNEF
UN, UNS
UNJC
UNJF

NPT
NPTF
Tr
EG

BGF

Vollhartmetall-Bohrungsschneidfräser für Innengewinde

Metrisches ISO-Feingewinde DIN 13

Ausführung: 2,5 x D, 45° Senkfase, Zylinderschaft und Rechtsspiralnuten

Solid carbide drill thread milling cutters for internal threads

ISO metric fine thread DIN 13

Specification: 2.5 x D, 45° chamfer for countersinking, straight shank and right hand spiral flutes

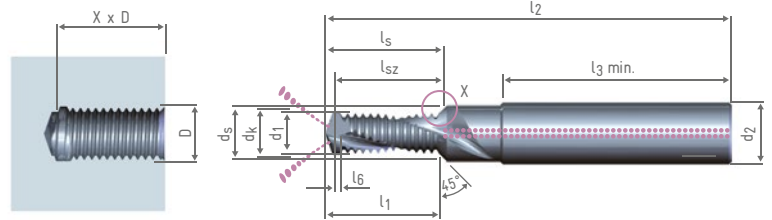
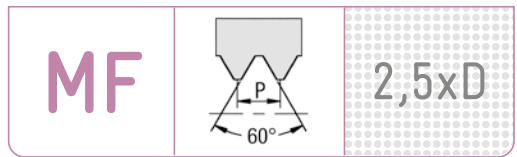
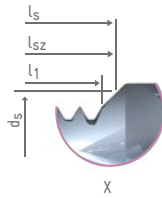

→HA (Zyl.-Schaft nach DIN 6535, Straight shank according to DIN 6535)

ORDER-CODE → BGF												2,5 x D		2,5 x D T		2,5 x D F	
D	P mm	l ₁	l ₂	l _{3 min.}	d ₂	d _s	l _s	l _{sz}	d _k	l ₆	z Nuten- zahl No. of flutes	blank uncoated	€	TiCN	€	TiAlN	€
M 5	0,5	13,30	54	36	6	5,3	12,5	11,7	4,50	0,5	2	410095	225,00	410100	243,00	410106	243,00
M 6	0,75	15,90	62	36	8	6,3	15,7	14,7	5,25	0,75	2	410096	201,00	410101	228,00	410107	228,00
M 8	1	21,20	74	40	10	8,4	22,1	20,8	7,00	1,0	2	410097	243,00	410102	271,00	410108	271,00
M 10	1	26,55	80	45	12	10,5	27,6	26,0	9,00	1,0	2	410098	295,00	410103	323,00	410109	323,00
M 12	1	30,95	90	45	14	12,6	32,0	30,0	11,00	1,0	2	410099	405,00	410104	435,00	410110	435,00
M 10	1,25	26,50	80	45	12	10,5	27,6	26,0	8,75	1,25	2	400540	306,00	410105	335,00	400538	335,00
M 12	1,5	31,80	90	45	14	12,6	33,1	31,2	10,50	1,5	2	400087	405,00	400907	435,00	400308	435,00

ORDER-CODE → BGF												2,5 x D K		2,5 x D KT		2,5 x D KF	
D	P mm	l ₁	l ₂	l _{3 min.}	d ₂	d _s	l _s	l _{sz}	d _k	l ₆	z Nuten- zahl No. of flutes	blank uncoated	€	TiCN	€	TiAlN	€
M 6	0,75	15,90	62	36	8	6,3	15,7	14,7	5,25	0,75	2	410111	264,00	410056	290,00	410122	290,00
M 8	1	21,20	74	40	10	8,4	22,1	20,8	7,00	1,0	2	410112	309,00	410115	336,00	410123	336,00
M 10	1	26,55	80	45	12	10,5	27,6	26,0	9,00	1,0	2	410113	364,00	410116	392,00	410124	392,00
M 12	1	30,95	90	45	14	12,6	32,0	30,0	11,00	1,0	2	410114	465,00	410117	494,00	410125	494,00
M 10	1,25	26,50	80	45	12	10,5	27,6	26,0	8,75	1,25	2	400157	375,00	410118	404,00	401059	404,00
M 12	1,5	31,80	90	45	14	12,6	33,1	31,2	10,50	1,5	2	400086	465,00	410119	494,00	400580	494,00
M 14	1,5	35,20	102	48	16	14,7	36,9	34,6	12,50	1,5	2	400288	611,00	410120	642,00	410126	642,00
M 16	1,5	41,50	102	48	18	16,8	43,3	40,7	14,50	1,5	2	400274	687,00	410121	718,00	410127	718,00

→ HB



→ HE



Zyl.-Schaft nach DIN 6535 HB oder HE, kein Zuschlag, keine Rücknahme möglich
Straight shank according to DIN 6535 HB or HE, no extra charge, no withdrawal possible

→ K

Kühlkanal
internal coolant

BGF 3

Vollhartmetall-Bohrungweidfräser für Innengewinde

Metrisches ISO-Feingewinde DIN 13

Ausführung: Z = 3, 2 x D bzw. 2,5 x D

45° Senkfase, Zylinderschaft mit Kühlkanal und Rechtsspiralnuten

Solid carbide drill thread milling cutters for internal threads

ISO metric fine thread DIN 13

Specification: Z = 3, 2 x D resp. 2.5 x D

45° chamfer for countersinking, straight shank with internal coolant and right hand spiral flutes

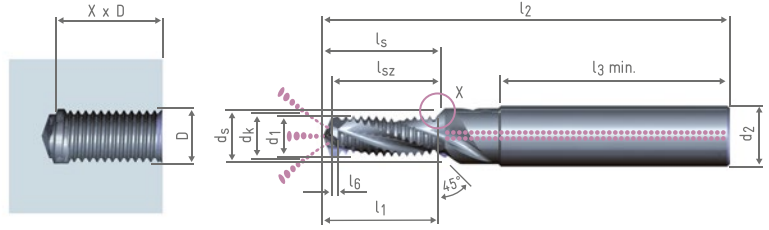
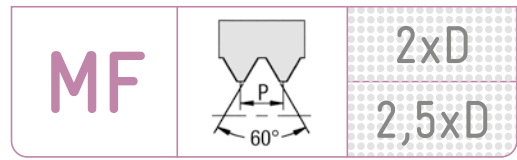
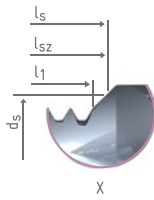

→HA (Zyl.-Schaft nach DIN 6535, Straight shank according to DIN 6535)

ORDER-CODE → BGF 3												2 x D		2 x D T		2 x D F				
D	P mm	l ₁	l ₂	l _{3 min.}	d ₂	d _s	l _s	l _{sz}	d _k	l ₆	Z Nuten- zahl No. of flutes	blank uncoated	TiCN	TiAlN	Art.-Nr.	€	Art.-Nr.	€	Art.-Nr.	€
M 6	0,75	12,90	62	36	8	6,3	13,6	12,6	5,25	0,75	3				411030	323,00	411034	350,00	411042	350,00
M 8	1	17,20	74	40	10	8,4	18,1	16,8	7,00	1,0	3				400263	353,00	410204	383,00	410205	383,00
M 10	1	21,55	80	45	12	10,5	22,6	21,0	9,00	1,0	3				400380	416,00	411036	448,00	411044	448,00
M 12	1	25,95	90	45	14	12,6	27,0	25,0	11,00	1,0	3				411032	530,00	411037	564,00	411045	564,00
M 10	1,25	21,50	80	45	12	10,5	22,6	21,0	8,75	1,25	3				411033	428,00	411038	461,00	411046	461,00
M 12	1,5	27,30	90	45	14	12,6	28,6	26,7	10,50	1,5	3				400372	530,00	411039	564,00	411047	564,00
M 14	1,5	30,70	102	48	16	14,7	32,4	30,1	12,50	1,5	3				400360	698,00	411040	733,00	411048	733,00
M 16	1,5	34,00	102	48	18	16,8	35,8	33,2	14,50	1,5	3				400341	784,00	411041	819,00	411049	819,00

ORDER-CODE → BGF 3												2,5 x D		2,5 x D T		2,5 x D F				
D	P mm	l ₁	l ₂	l _{3 min.}	d ₂	d _s	l _s	l _{sz}	d _k	l ₆	Z Nuten- zahl No. of flutes	blank uncoated	TiCN	TiAlN	Art.-Nr.	€	Art.-Nr.	€	Art.-Nr.	€
M 6	0,75	15,90	62	36	8	6,3	15,7	14,7	5,25	0,75	3				411050	340,00	411055	368,00	411063	368,00
M 8	1	21,20	74	40	10	8,4	22,1	20,8	7,00	1,0	3				411052	371,00	410207	403,00	410206	403,00
M 10	1	26,55	80	45	12	10,5	27,6	26,0	9,00	1,0	3				411053	437,00	411057	471,00	411065	471,00
M 12	1	30,95	90	45	14	12,6	32,0	30,0	11,00	1,0	3				411054	557,00	411058	593,00	411066	593,00
M 10	1,25	26,50	80	45	12	10,5	27,6	26,0	8,75	1,25	3				401092	450,00	411059	484,00	411067	484,00
M 12	1,5	31,80	90	45	14	12,6	33,1	31,2	10,50	1,5	3				400141	557,00	411060	593,00	411068	593,00
M 14	1,5	35,20	102	48	16	14,7	36,9	34,6	12,50	1,5	3				400361	733,00	411061	770,00	411069	770,00
M 16	1,5	41,50	102	48	18	16,8	43,3	40,7	14,50	1,5	3				400342	824,00	411062	861,00	411070	861,00

3 x D auf Anfrage

3 x D on request

→ HB



→ HE

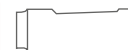

Zyl.-Schaft nach DIN 6535 HB oder HE, kein Zuschlag, keine Rücknahme möglich
Straight shank according to DIN 6535 HB or HE, no extra charge, no withdrawal possible

→ K

Kühlkanal
internal coolant



M
MF
MJ
EG M

G
Rc, R
Pg

UNC
UNF
UN
UNJF

NPT
NPTF

M
MF
M keg.
M taper

G
BSW
BSF
DIN 477
R, BA, Pg

UNC
UNF
UNEF
UN, UNS

NPSM
NPT
NPTF
Tr, Rd

M
MF

G
BSW
BSF
R, Pg
MF-EL

UNC, UNF
UNEF
UN, UNS
UNJF
UNJF

NPT
NPTF
Tr
EG

GFW-Q

Wendeplatten-Gewindefräser
für Innengewinde

Metrisches ISO-Gewinde DIN 13

Ausführung: Zylinderschaft HB mit Kühlkanal

Indexable thread milling cutters
for internal threads

ISO metric thread DIN 13

Specification: straight shank HB
with internal coolant



M

MF

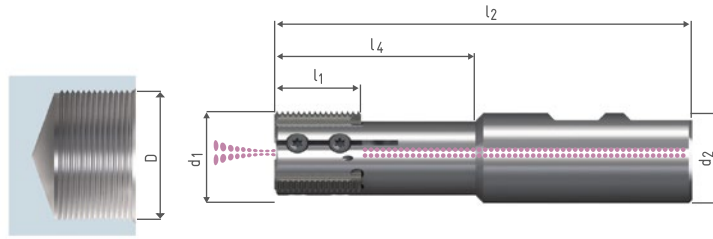
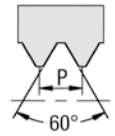

ORDER-CODE → GFW-Q →										T		
Haltertyp Type of holder	d ₁ Fräser-Nenn Ø Cutter nom. Ø	P mm ↓	D _z für Gew - Ø for thread Ø	l ₁	l ₂	d ₂	l ₄ Nutz- länge use length	z Nuten- zahl No. of flutes	blank uncoated	TiCN		
									Art.-Nr.	€	Art.-Nr.	€
GFW-Q 26 (Art.-Nr. 305817)	26	1	M 28x1	24,00	115	25 h6	50	3	630127	○	630131	○
	26	1,5	M 30x1,5	24,00	115	25 h6	50	3	630128	○	630132	○
	26	2	M 30x2	24,00	115	25 h6	50	3	630126	○	630133	○
	26	3	M 32x3	24,00	115	25 h6	50	3	630129	○	630134	○
	26	3,5	M 33 (x3,5)	24,50	115	25 h6	50	3	630130	○	630135	○
	26	4	M 36 (x4)	24,00	115	25 h6	50	3	630121	○	630136	○

Ersatzschraube Art.-Nr. 305911

Replacement screw art.no. 305911

ORDER-CODE → GFW-Q →										T		
Haltertyp Type of holder	d ₁ Fräser-Nenn Ø Cutter nom. Ø	P mm ↓	D _z für Gew - Ø for thread Ø	l ₁	l ₂	d ₂	l ₄ Nutz- länge use length	z Nuten- zahl No. of flutes	blank uncoated	TiCN		
									Art.-Nr.	€	Art.-Nr.	€
GFW-Q 33 (Art.-Nr. 305977)	33	1	M 36x1	40,00	150	32 h6	85	3	630159	○	630160	○
	33	2	M 38x2	40,00	150	32 h6	85	3	630161	○	630162	○
	33	3	M 40x3	39,00	150	32 h6	85	3	630163	○	630164	○
	33	4	M 42x4	40,00	150	32 h6	85	3	630164	○	630165	○
	33	4,5	M 42 (x4,5)	40,50	150	32 h6	85	3	630137	○	630139	○
	33	5	M 48 (x5)	40,00	150	32 h6	85	3	630138	○	630158	○

Ersatzschraube Art.-Nr. 305966

Replacement screw art.no. 305966

ORDER-CODE → GFW-Q →										T		
Haltertyp Type of holder	d ₁ Fräser-Nenn Ø Cutter nom. Ø	P mm ↓	D _z für Gew - Ø for thread Ø	l ₁	l ₂	d ₂	l ₄ Nutz- länge use length	z Nuten- zahl No. of flutes	blank uncoated	TiCN		
									Art.-Nr.	€	Art.-Nr.	€
GFW-Q 41 (Art.-Nr. 306394)	41	2	M 45x2	48,00	175	40 h6	100	4	630167	○	630168	○
	41	3	M 48x3	48,00	175	40 h6	100	4	630169	○	630170	○
	41	4	M 52x4	48,00	175	40 h6	100	4	630171	○	630172	○
	41	5,5	M 56 (x5,5)	49,50	175	40 h6	100	4	630175	○	630176	○
	41	6	M 64 (x6)	48,00	175	40 h6	100	4	630177	○	630178	○

Ersatzschraube Art.-Nr. 305967

Replacement screw art.no. 305967

Beachten Sie den kleinsten fräsbaren Gewindedurchmesser D_z

Caution - please look at the smallest thread diameter D_z
for the GFW-Q tool system

○ am Lager, Preis auf Anfrage

○ in stock, price on request

GF

Vollhartmetall-Gewindefräser für Innengewinde

Whitworth-Rohrgewinde DIN EN ISO 228, auch verwendbar für DIN EN 10226-1, ISO 7-1, DIN 2999, DIN 3858, BS 21

Ausführung: 1,5 x D, 2 x D bzw. 2,5 x D, Zylinderschaft mit Kühlkanal und Rechtsspiralnuten

Solid carbide thread milling cutters for internal threads

Whitworth pipe thread DIN EN ISO 228, also suitable for DIN EN 10226-1, ISO 7-1, DIN 2999, DIN 3858, BS 21

Specification: 1.5 x D, 2 x D resp. 2.5 x D, straight shank with internal coolant and right hand spiral flutes

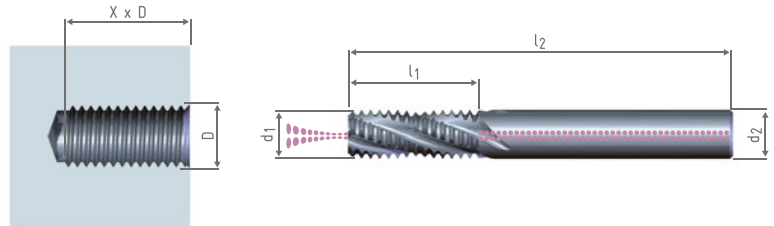
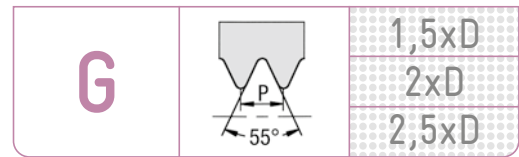

→HA (Zyl.-Schaft nach DIN 6535, Straight shank according to DIN 6535)

ORDER-CODE → GF							1,5 x D		1,5 x D T		1,5 x D F	
D	P Gg/1" tpi	l ₁	l ₂	d ₂	Z Nuten- zahl No. of flutes	blank uncoated	TiCN		TiAlN			
↓												
						Art.-Nr.	€	Art.-Nr.	€	Art.-Nr.	€	
G 1/8"	28	15,80	64	8	4	300105	162,00	301116	187,00	300928	187,00	
G 1/4"	19	22,00	74	10	4	300103	207,00	304930	232,00	300100	232,00	
G 3/8"	19	27,30	90	14	4	300065	269,00	310022	297,00	301846	297,00	

ORDER-CODE → GF							2 x D		2 x D T		2 x D F	
D	P Gg/1" tpi	l ₁	l ₂	d ₂	Z Nuten- zahl No. of flutes	blank uncoated	TiCN		TiAlN			
↓												
						Art.-Nr.	€	Art.-Nr.	€	Art.-Nr.	€	
G 1/8"	28	21,30	64	8	4	300241	162,00	301114	187,00	300247	187,00	
G 1/4"	19	28,70	74	10	4	300242	207,00	301115	232,00	300248	232,00	
G 3/8"	19	35,50	90	14	4	300243	269,00	301153	297,00	300249	297,00	
G 1/2"	14	44,30	102	16	5	305822	340,00	305823	374,00	306441	374,00	

ORDER-CODE → GF							2,5 x D		2,5 x D T		2,5 x D F	
D	P Gg/1" tpi	l ₁	l ₂	d ₂	Z Nuten- zahl No. of flutes	blank uncoated	TiCN		TiAlN			
↓												
						Art.-Nr.	€	Art.-Nr.	€	Art.-Nr.	€	
G 1/8"	28	24,90	64	8	4	300935	172,00	301736	199,00	300938	199,00	
G 1/4"	19	35,40	74	10	4	300943	219,00	301653	246,00	302773	246,00	
G 3/8"	19	43,50	90	14	4	300636	285,00	301737	315,00	302806	315,00	

3 x D auf Anfrage

3 x D on request

→ HB



→ HE

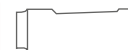

Zyl.-Schaft nach DIN 6535 HB oder HE, kein Zuschlag, keine Rücknahme möglich
Straight shank according to DIN 6535 HB or HE, no extra charge, no withdrawal possible



M
MF
MJ
EG M

G
Rc, R
Pg

UNC
UNF
UN
UNJF

NPT
NPTF

M
MF
M keg.
M taper

G
BSW
BSF
DIN 477
R, BA, Pg

UNC
UNF
UNEF
UN, UNS

NPSM
NPT
NPTF
Tr, Rd

M
MF

G
BSW
BSF
R, Pg
MF-EL

UNC, UNF
UNEF
UN, UNS
UNJC
UNJF

NPT
NPTF
Tr
EG

GFS

Vollhartmetall-Gewindefräser für Innengewinde

Whitworth-Rohrgewinde DIN EN ISO 228, auch verwendbar für DIN EN 10226-1, ISO 7-1, DIN 2999, DIN 3858, BS 21

Ausführung: 1,5 x D, 2 x D bzw. 2,5 x D, 45° Senkfase, Zylinderschaft mit Kühlkanal und Rechtsspiralnuten

Solid carbide thread milling cutters for internal threads

Whitworth pipe thread DIN EN ISO 228, also suitable for DIN EN 10226-1, ISO 7-1, DIN 2999, DIN 3858, BS 21

Specification: 1.5 x D, 2 x D resp. 2.5 x D
45° chamfer for countersinking, straight shank with internal coolant and right hand spiral flutes

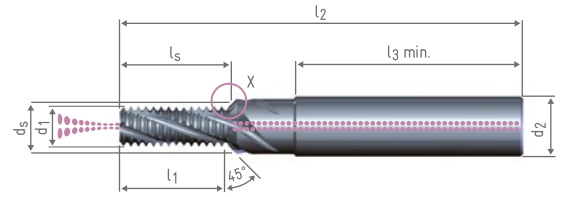
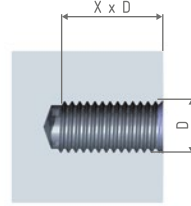
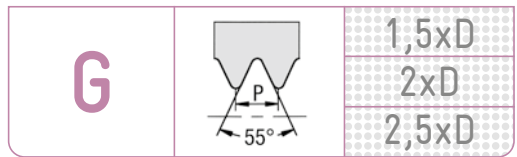
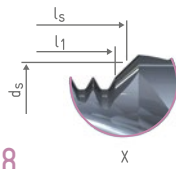

→ HA (Zyl.-Schaft nach DIN 6535, Straight shank according to DIN 6535)

ORDER-CODE → GFS										1,5 x D		1,5 x D T		1,5 x D F		
D	P Gg/1" tpi	l ₁	l ₂	l _{3 min.}	d ₂	d _s	l _s	Z Nuten- zahl No. of flutes	blank uncoated	TiCN	TiAlN					
↓																
									Art.-Nr.	€	Art.-Nr.	€	Art.-Nr.	€		
G 1/8"	28	15,80	80	45	12	10,2	16,9	4	300080	210,00	303153	238,00	301868	238,00		
G 1/4"	19	22,00	90	45	14	13,8	23,4	4	300081	298,00	304993	327,00	301869	327,00		
G 3/8"	19	27,30	102	48	18	17,5	28,9	4	300082	400,00	310125	431,00	301870	431,00		

ORDER-CODE → GFS										2 x D		2 x D T		2 x D F		
D	P Gg/1" tpi	l ₁	l ₂	l _{3 min.}	d ₂	d _s	l _s	Z Nuten- zahl No. of flutes	blank uncoated	TiCN	TiAlN					
↓																
									Art.-Nr.	€	Art.-Nr.	€	Art.-Nr.	€		
G 1/8"	28	21,25	80	45	12	10,2	22,3	4	300183	210,00	301180	238,00	300401	238,00		
G 1/4"	19	28,65	90	45	14	13,8	30,1	4	300184	298,00	301182	327,00	300402	327,00		
G 3/8"	19	35,35	102	48	18	17,5	36,9	4	300185	400,00	301184	431,00	300403	431,00		

2,5 x D auf Anfrage

2,5 x D on request

3 x D auf Anfrage

3 x D on request

→ HB



→ HE



Zyl.-Schaft nach DIN 6535 HB oder HE, kein Zuschlag, keine Rücknahme möglich
Straight shank according to DIN 6535 HB or HE, no extra charge, no withdrawal possible

GFM

Vollhartmetall-Gewindefräser
für Innen- und Außengewinde

Whitworth-Rohrgewinde DIN EN ISO 228,
auch verwendbar für DIN EN 10226-1, ISO 7-1,
DIN 2999, DIN 3858, BS 84, BS 21

Ausführung: Zylinderschaft mit Kühlkanal und
Rechtsspiralnuten

**Solid carbide thread milling cutters
for internal and external threads**

Whitworth pipe thread DIN EN ISO 228,
also suitable for DIN EN 10226-1, ISO 7-1,
DIN 2999, DIN 3858, BS 84, BS 21

Specification: straight shank with internal coolant
and right hand spiral flutes

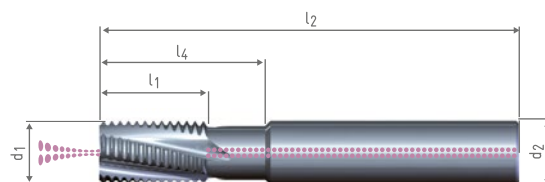
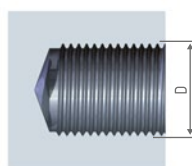

→HA (Zyl.-Schaft nach DIN 6535, Straight shank according to DIN 6535)

ORDER-CODE → GFM G								T		F			
d ₁ Fräser Nenn-Ø Cutter nom. Ø ↓	P Gg/1" tpi ↓	D≥ für Gew - Ø for thread Ø	l ₁	l ₂	d ₂	l ₄ Nutz- länge use length	z Nuten- zahl No. of flutes	blank uncoated	TiCN	TiAlN			
								Art.-Nr.	€	Art.-Nr.	€		
10	19	G 1/4"	16	70	10	25	4	300304	200,00	301244	219,00	300307	219,00
16	14	G 1/2"	25	90	16	40	5	300305	321,00	300961	352,00	300308	352,00
20	11	G 1"	33	105	20	50	5	300306	471,00	301208	506,00	300309	506,00
25	11	G 1 1/2"	40	115	25	57	6	311010	653,00	311011	702,00	311012	702,00

Beachten Sie den kleinsten fräsbaren Gewindedurchmesser D≥

Caution - please look at the smallest thread diameter D≥
for the GFM tool system

→ HB

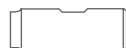

→ HE

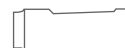

Zyl.-Schaft nach DIN 6535 HB oder HE, kein Zuschlag, keine Rücknahme möglich
Straight shank according to DIN 6535 HB or HE, no extra charge, no withdrawal possible



- M
MF
MJ
EG M
- G
Rc, R
Pg
- UNC
UNF
UN
UNJF
- NPT
NPTF
- M
MF
M keg.
M taper
- G
BSW
BSF
DIN 477
R, BA, Pg
- UNC
UNF
UNEF
UN, UNS
- NPSM
NPT
NPTF
Tr, Rd
- M
MF
- G
BSW
BSF
R, Pg
MF-EL
- UNC, UNF
UNEF
UN, UNS
UNJC
UNJF
- NPT
NPTF
Tr
EG

GFM

Vollhartmetall-Gewindefräser
für Innengewinde Rc und Außengewinde R

Kegeliges Whitworth-Rohrgewinde
DIN EN 10226, ISO 7-1, DIN 2999, DIN 3858,
BS 21

Kegel 1:16, Für im Gewinde dichtende Verbindungen
Ausführung: Zylinderschaft mit Kühlkanal und
Rechtsspiralnuten

Solid carbide thread milling cutters
for internal threads Rc and external threads R

Tapered Whitworth pipe thread DIN EN 10226, ISO 7-1,
DIN 2999, DIN 3858, BS 21

Taper 1:16, Where pressure-tight joints are made on
the threads

Specification: straight shank with internal coolant and
right hand spiral flutes

Rc

R

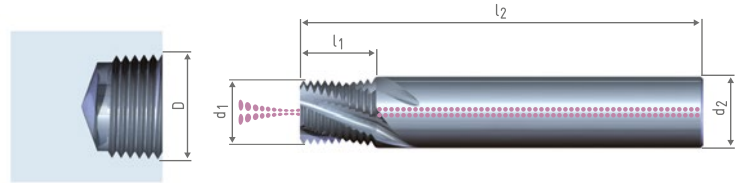

→HA (Zyl.-Schaft nach DIN 6535, Straight shank according to DIN 6535)

ORDER-CODE → GFM Rc/R →							blank uncoated		TiCN	
d ₁ Fräser Nenn-Ø Cutter nom. Ø ↓	P Gg/1" tpi	D≥ für Gew - Ø for thread Ø	l ₁	l ₂	d ₂	z Nuten- zahl No. of flutes	Art.-Nr.	€	Art.-Nr.	€
7,4	28	Rc/R 1/8"	8,60	64	8	4	311025	245,00	311026	279,00
9,1	19	Rc/R 1/4"	13,95	74	10	4	311027	260,00	311030	287,00
14,8	14	Rc/R 1/2"	18,95	90	16	5	311028	390,00	311031	419,00
18	11	Rc/R 1"	33,30	105	20	5	311029	560,00	311032	598,00

Beachten Sie den kleinsten fräsbaren Gewindedurchmesser D≥

Caution - please look at the smallest thread diameter D≥
for the GFM tool system



Zyl.-Schaft nach DIN 6535 HB oder HE, kein Zuschlag, keine Rücknahme möglich
Straight shank according to DIN 6535 HB or HE, no extra charge, no withdrawal possible



GFM

Vollhartmetall-Gewindefräser
für Innen- und Aussengewinde

Stahlpanzerrohr-Gewinde DIN 40430

Ausführung: Zylinderschaft mit Kühlkanal
und Rechtsspiralnuten

**Solid carbide thread milling cutters
for internal and external threads**

Steel conduit thread DIN 40430

Specification: straight shank with internal coolant
and right hand spiral flutes

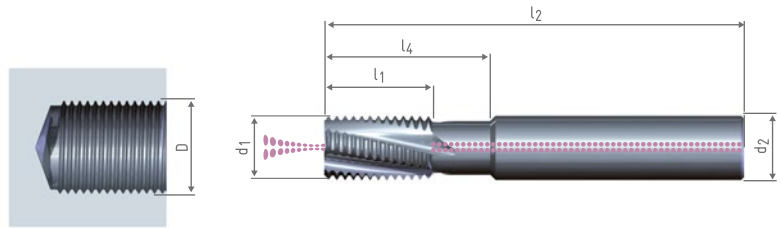
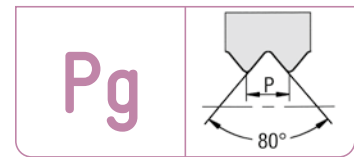

→HA (Zyl.-Schaft nach DIN 6535, Straight shank according to DIN 6535)

ORDER-CODE → GFM Pg								T	F				
d ₁ Fräser Nenn-Ø Cutter nom. Ø ↓	P Gg/1" tpi ↓	D≥ für Gew - Ø for thread Ø	l ₁	l ₂	d ₂	l ₄ Nutz- länge use length	z Nuten- zahl No. of flutes	blank uncoated	TiCN	TiAlN			
								Art.-Nr.	€	Art.-Nr.	€	Art.-Nr.	€
10	20	Pg 7	16,00	70	10	25	4	300310	219,00	301523	240,00	300313	240,00
12	18	Pg 9	20,00	80	12	31	4	300311	246,00	301524	272,00	300314	272,00
16	16	Pg 21	25,00	90	16	40	5	300312	309,00	304847	340,00	300315	340,00

Beachten Sie den kleinsten fräsbaren Gewindedurchmesser D≥

Caution - please look at the smallest thread diameter D≥
for the GFM tool system

→ HB



→ HE



Zyl.-Schaft nach DIN 6535 HB oder HE, kein Zuschlag, keine Rücknahme möglich
Straight shank according to DIN 6535 HB or HE, no extra charge, no withdrawal possible



- M
MF
MJ
EG M
- G
Rc, R
Pg
- UNC
UNF
UN
UNJF
- NPT
NPTF
- M
MF
M keg.
M taper
- G
BSW
BSF
DIN 477
R, BA, Pg
- UNC
UNF
UNEF
UN, UNS
- NPSM
NPT
NPTF
Tr, Rd
- M
MF
- G
BSW
BSF
R, Pg
MF-EL
- UNC, UNF
UNEF
UN, UNS
UNJC
UNJF
- NPT
NPTF
Tr
EG

GF

Vollhartmetall-Gewindefräser für Innengewinde

UNC-Grobgewinde ASME B1.1

Ausführung: 2 x D bzw. 2,5 x D
Zylinderschaft und Rechtsspiralnuten

Solid carbide thread milling cutters for internal threads

Unified national coarse thread ASME B1.1
Specification: 2 x D resp. 2.5 x D
straight shank and right hand spiral flutes

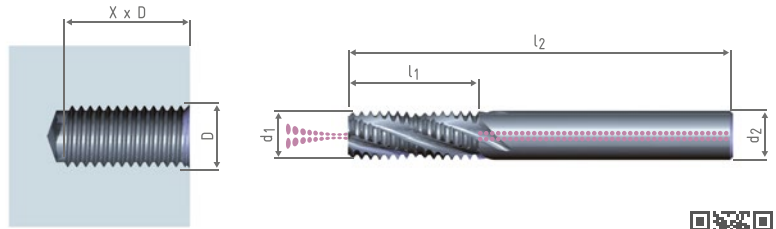
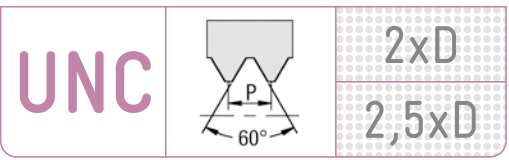

→HA (Zyl.-Schaft nach DIN 6535, Straight shank according to DIN 6535)

ORDER-CODE → GF							→ 2 x D KT		
D	P Gg/1" tpi	l ₁	l ₂	d ₂	Z Nuten- zahl No. of flutes	TiCN	Art.-Nr.	€	
↓									
UNC Nr. 10	24	GFS verwenden (siehe Seite 106)							
UNC Nr. 12	24	use GFS (see page 106)							
UNC 1/4"	20	14,50	54	6	3	304858	152,00		
UNC 5/16"	18	17,60	54	6	3	304859	152,00		
UNC 3/8"	16	21,40	64	8	4	304860	168,00		
UNC 7/16"	14	24,40	64	8	4	304861	168,00		
UNC 1/2"	13	28,30	74	10	4	304862	208,00		

ORDER-CODE → GF							→ 2,5 x D KT		
D	P Gg/1" tpi	l ₁	l ₂	d ₂	Z Nuten- zahl No. of flutes	TiCN	Art.-Nr.	€	
↓									
UNC Nr. 10	24	GFS verwenden (siehe Seite 107)							
UNC Nr. 12	24	use GFS (see page 107)							
UNC 1/4"	20	17,10	54	6	3	310026	162,00		
UNC 5/16"	18	20,40	54	6	3	310027	162,00		
UNC 3/8"	16	24,50	64	8	4	310028	178,00		
UNC 7/16"	14	28,00	64	8	4	310029	178,00		
UNC 1/2"	13	32,20	74	10	4	310030	220,00		

3 x D auf Anfrage

3 x D on request



Zyl.-Schaft nach DIN 6535 HB oder HE, kein Zuschlag, keine Rücknahme möglich
Straight shank according to DIN 6535 HB or HE, no extra charge, no withdrawal possible



GF

Vollhartmetall-Gewindefräser für Innengewinde

UNF-Feingewinde ASME B1.1

Ausführung: 2 x D bzw. 2,5 x D
Zylinderschaft und Rechtsspiralnuten

Solid carbide thread milling cutters for internal threads

Unified national fine thread ASME B1.1
Specification: 2 x D resp. 2.5 x D
Straight shank and right hand spiral flutes

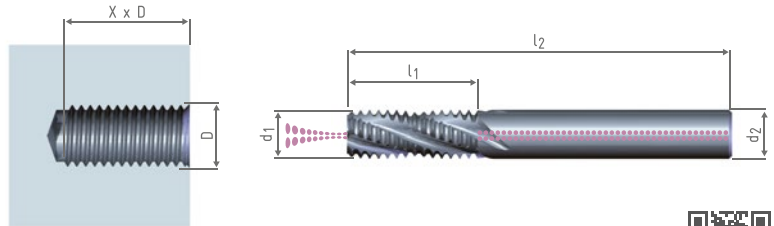
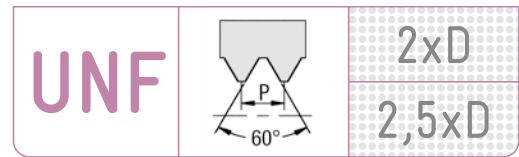

→HA (Zyl.-Schaft nach DIN 6535, Straight shank according to DIN 6535)

ORDER-CODE → GF						→ 2 x D KT		
D	P Gg/1" tpi	l ₁	l ₂	d ₂	Z Nuten- zahl No. of flutes	TiCN		
↓								
						Art.-Nr.	€	
UNF Nr. 10	32	GFS verwenden (siehe Seite 109)						
UNF Nr. 12	28	use GFS (see page 109)						
UNF 1/4"	28	14,00	54	6	3	304863	160,00	
UNF 5/16"	24	17,40	54	6	3	304613	174,00	
UNF 3/8"	24	20,60	64	8	4	301119	187,00	
UNF 7/16"	20	24,70	64	8	4	301117	180,00	
UNF 1/2"	20	27,30	74	10	4	304864	227,00	

ORDER-CODE → GF						→ 2,5 x D KT		
D	P Gg/1" tpi	l ₁	l ₂	d ₂	Z Nuten- zahl No. of flutes	TiCN		
↓								
						Art.-Nr.	€	
UNF Nr. 10	32	GFS verwenden (siehe Seite 110)						
UNF Nr. 12	28	use GFS (see page 110)						
UNF 1/4"	28	16,70	54	6	3	310033	170,00	
UNF 5/16"	24	20,60	54	6	3	310034	184,00	
UNF 3/8"	24	24,80	64	8	4	310035	199,00	
UNF 7/16"	20	28,50	64	8	4	310036	192,00	
UNF 1/2"	20	32,30	74	10	4	310037	241,00	

3 x D auf Anfrage

3 x D on request



Zyl.-Schaft nach DIN 6535 HB oder HE, kein Zuschlag, keine Rücknahme möglich
Straight shank according to DIN 6535 HB or HE, no extra charge, no withdrawal possible



GF

Vollhartmetall-Gewindefräser für Innengewinde

UNJF-Feingewinde ISO 3161, ASME B1.15

Ausführung: 2 x D

Zylinderschaft mit Kühlkanal und Rechtsspiralnuten

Solid carbide thread milling cutters for internal threads

UNJF Unified national fine thread ISO 3161, ASME B1.15

Specification: 2 x D, straight shank with internal coolant and right hand spiral flutes

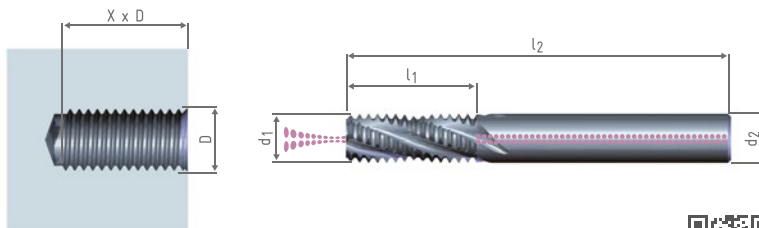
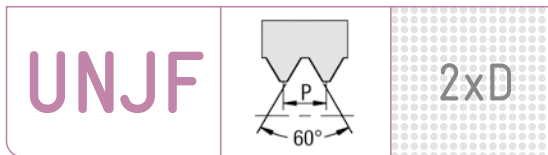

→ HA (Zyl.-Schaft nach DIN 6535, Straight shank according to DIN 6535)

ORDER-CODE → GF						→ 2 x D T	
D	P Gg/1" tpi	l ₁	l ₂	d ₂	Z Nuten- zahl No. of flutes	TiCN	
↓						Art.-Nr.	€
UNJF Nr. 10*	32	11,50	54	6	3	305887	201,00
UNJF 1/4"	28	14,30	54	6	3	305888	222,00
UNJF 5/16"	24	17,40	54	6	3	305890	222,00
UNJF 3/8"	24	20,60	64	8	4	305889	254,00
UNJF 7/16"	20	24,70	64	8	4	305891	275,00
UNJF 1/2"	20	27,30	74	10	4	305892	344,00

* Ausführung GFS

* design GFS



Zyl.-Schaft nach DIN 6535 HB oder HE, kein Zuschlag, keine Rücknahme möglich
Straight shank according to DIN 6535 HB or HE, no extra charge, no withdrawal possible



GFS

Vollhartmetall-Gewindefräser für Innengewinde

UNC-Grobgewinde ASME B1.1

Ausführung: 1,5 x D, 45° Senkfase, Zylinderschaft und Rechtsspiralnuten

Solid carbide thread milling cutters for internal threads

Unified national coarse thread ASME B1.1
Specification: 1.5 x D, 45° chamfer for countersinking, straight shank and right hand spiral flutes

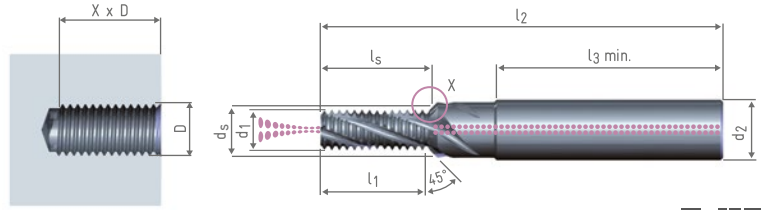
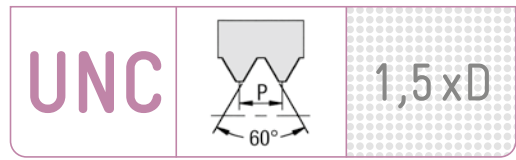
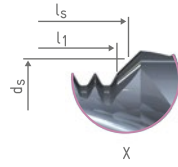

→HA (Zyl.-Schaft nach DIN 6535, Straight shank according to DIN 6535)

ORDER-CODE → GFS									→ 1,5 x D KT	
D	P Gg/1" tpi	l ₁	l ₂	l _{3 min.}	d ₂	d _s	l _s	Z Nuten- zahl No. of flutes	TiCN	
↓										Art.-Nr. €
UNC Nr. 8	32	7,50	48	36	6	4,4	8,1	3	TiCN	310139 180,00
UNC Nr. 10	24	9,00	54	36	6	5,1	9,7	3	TiCN	310140 180,00
UNC Nr. 12	24	10,00	54	36	6	5,8	10,9	3	TiCN	310141 180,00
UNC 1/4"	20	12,00	62	36	8	6,7	13,0	3	TiCN	304467 188,00
UNC 5/16"	18	14,75	74	40	10	8,3	15,9	3	TiCN	310142 198,00
UNC 3/8"	16	16,60	80	45	12	10,0	17,9	4	TiCN	304468 218,00
UNC 7/16"	14	19,00	80	45	12	11,7	20,4	4	TiCN	310143 218,00
UNC 1/2"	13	22,40	90	45	14	13,3	23,9	4	TiCN	305135 311,00
UNC 9/16"	12	24,25	102	48	16	15,0	26,0	4	TiCN	310144 361,00
UNC 5/8"	11	26,50	102	48	18	16,7	28,3	4	TiCN	310145 454,00

→ HB



→ HE



Zyl.-Schaft nach DIN 6535 HB oder HE, kein Zuschlag, keine Rücknahme möglich
Straight shank according to DIN 6535 HB or HE, no extra charge, no withdrawal possible

→ K

Kühlkanal
internal coolant



M
MF
MJ
EG M

G
Rc, R
Pg

UNC
UNF
UN
UNJF

NPT
NPTF

M
MF
M keg.
M taper

G
BSW
BSF
R, Pg
MF-EL

UNC
UNF
UNEF
UN, UNS

NPSM
NPT
NPTF
Tr, Rd

M
MF

G
BSW
BSF
R, Pg
MF-EL

UNC, UNF
UNEF
UN, UNS
UNJC
UNJF

NPT
NPTF
Tr
EG

GFS

Vollhartmetall-Gewindefräser für Innengewinde

UNC-Grobgewinde ASME B1.1

Ausführung: 2 x D, 45° Senkfase, Zylinderschaft und Rechtsspiralnuten

Solid carbide thread milling cutters for internal threads

Unified national coarse thread ASME B1.1
Specification: 2 x D, 45° chamfer for countersinking, straight shank and right hand spiral flutes

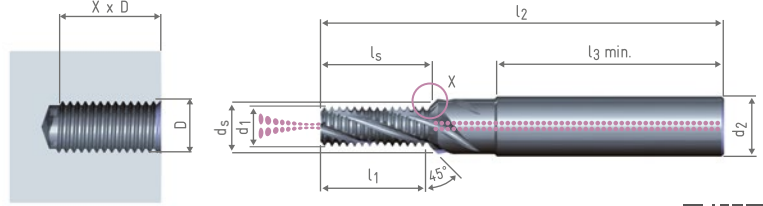
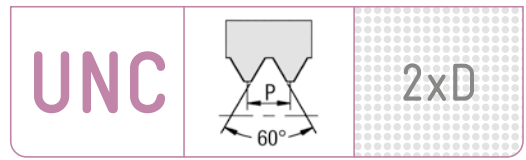
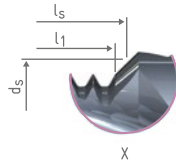

→ HA (Zyl.-Schaft nach DIN 6535, Straight shank according to DIN 6535)

ORDER-CODE → GFS										2 x D T	
D	P Gg/1" tpi	l ₁	l ₂	l _{3 min.}	d ₂	d _s	l _s	Z Nuten- zahl No. of flutes	TiCN	Art.-Nr.	€
UNC Nr. 4	40	6,00	48	36	6	3,0	7,50	3		310150	184,00
UNC Nr. 6	32	8,30	48	36	6	3,7	10,00	3		310151	171,00

ORDER-CODE → GFS										2 x D KT	
D	P Gg/1" tpi	l ₁	l ₂	l _{3 min.}	d ₂	d _s	l _s	Z Nuten- zahl No. of flutes	TiCN	Art.-Nr.	€
UNC Nr. 8	32	9,10	48	36	6	4,4	9,7	3		304957	180,00
UNC Nr. 10	24	11,05	54	36	6	5,1	11,9	3		304963	180,00
UNC Nr. 12	24	12,15	54	36	6	5,8	13,0	3		304958	180,00
UNC 1/4"	20	14,55	62	36	8	6,7	15,6	3		304869	188,00
UNC 5/16"	18	17,60	74	40	10	8,3	18,7	3		304870	198,00
UNC 3/8"	16	21,40	80	45	12	10,0	22,6	4		301684	218,00
UNC 7/16"	14	24,45	80	45	12	11,7	25,9	4		304871	218,00
UNC 1/2"	13	28,25	90	45	14	13,3	29,8	4		304872	311,00
UNC 9/16"	12	30,65	102	48	16	15,0	32,3	4		304873	361,00
UNC 5/8"	11	35,70	102	48	18	16,7	37,6	4		304665	454,00

→ HB

→ HE

Zyl.-Schaft nach DIN 6535 HB oder HE, kein Zuschlag, keine Rücknahme möglich
Straight shank according to DIN 6535 HB or HE, no extra charge, no withdrawal possible

→ K Kühlkanal
internal coolant

GFS

Vollhartmetall-Gewindefräser für Innengewinde

UNC-Grobgewinde ASME B1.1

Ausführung: 2,5 x D, 45° Senkfase, Zylinderschaft und Rechtspiralnuten

Solid carbide thread milling cutters for internal threads

Unified national coarse thread ASME B1.1
Specification: 2.5 x D, 45° chamfer for countersinking, straight shank and right hand spiral flutes

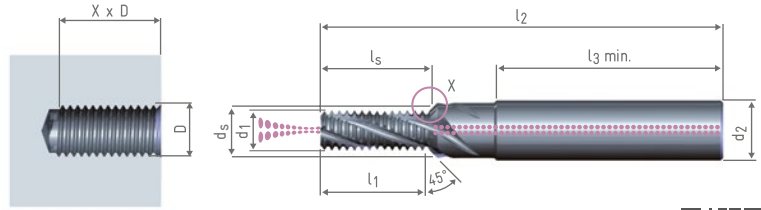
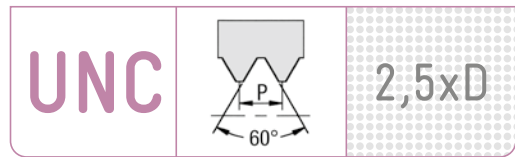
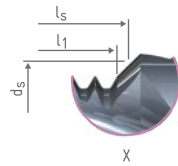

→HA (Zyl.-Schaft nach DIN 6535, Straight shank according to DIN 6535)

ORDER-CODE → GFS									→ 2,5 x D KT	
D	P Gg/1" tpi	l ₁	l ₂	l _{3 min.}	d ₂	d _s	l _s	Z Nuten- zahl No. of flutes	TiCN	
↓									Art.-Nr.	€
UNC Nr. 10	24	13,20	54	36	6	5,1	14,0	3	310183	189,00
UNC Nr. 12	24	14,25	54	36	6	5,8	15,1	3	310184	189,00
UNC 1/4"	20	17,10	62	36	8	6,7	18,1	3	310185	198,00
UNC 5/16"	18	20,40	74	40	10	8,3	21,5	3	310186	208,00
UNC 3/8"	16	24,55	80	45	12	10,0	25,8	4	310187	229,00
UNC 7/16"	14	28,05	80	45	12	11,7	29,5	4	310188	229,00
UNC 1/2"	13	32,20	90	45	14	13,3	33,7	4	310189	328,00
UNC 9/16"	12	37,00	102	48	16	15,0	38,7	4	310190	381,00
UNC 5/8"	11	40,35	102	48	18	16,7	42,2	4	310191	489,00

3 x D auf Anfrage

3 x D on request



Zyl.-Schaft nach DIN 6535 HB oder HE, kein Zuschlag, keine Rücknahme möglich
Straight shank according to DIN 6535 HB or HE, no extra charge, no withdrawal possible



- M
MF
MJ
EG M
- G
Rc, R
Pg
- UNC
UNF
UN
UNJF
- NPT
NPTF
- M
MF
M keg.
M taper
- G
BSW
BSF
DIN 477
R, BA, Pg
- UNC
UNF
UNEF
UN, UNS
- NPSM
NPT
NPTF
Tr, Rd
- M
MF
- G
BSW
BSF
R, Pg
MF-EL
- UNC, UNF
UNEF
UN, UNS
UNJC
UNJF
- NPT
NPTF
Tr
EG

GFS

Vollhartmetall-Gewindefräser für Innengewinde

UNF-Feingewinde ASME B1.1

Ausführung: 1,5 x D, 45° Senkfase, Zylinderschaft und Rechtsspiralnuten

Solid carbide thread milling cutters for internal threads

Unified national fine thread ASME B1.1

Specification: 1.5 x D, 45° chamfer for countersinking, straight shank and right hand spiral flutes

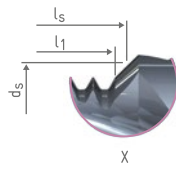

UNF



1,5 x D

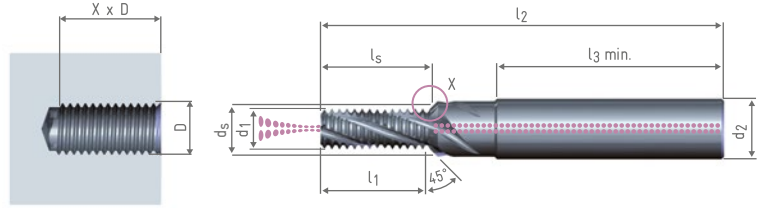

→ HA (Zyl.-Schaft nach DIN 6535, Straight shank according to DIN 6535)

ORDER-CODE → GFS									→ 1,5 x D KT	
D	P Gg/1" tpi	l ₁	l ₂	l _{3 min.}	d ₂	d _s	l _s	Z Nuten- zahl No. of flutes	TiCN	
↓									Art.-Nr.	€
UNF Nr. 10	32	8,30	54	36	6	5,1	9,0	3	310211	172,00
UNF Nr. 12	28	9,50	54	36	6	5,8	10,3	3	310212	172,00
UNF 1/4"	28	11,30	62	36	8	6,7	12,1	3	310213	187,00
UNF 5/16"	24	13,20	74	40	10	8,3	14,1	3	310214	210,00
UNF 3/8"	24	16,35	80	45	12	10,0	17,4	4	301674	234,00
UNF 7/16"	20	18,35	80	45	12	11,7	19,6	4	304799	234,00
UNF 1/2"	20	20,90	90	45	14	13,3	22,1	4	310215	331,00
UNF 9/16"	18	23,25	102	48	16	15,0	24,6	4	310216	361,00
UNF 5/8"	18	26,05	102	48	18	16,7	27,5	4	310217	454,00

→ HB



→ HE



Zyl.-Schaft nach DIN 6535 HB oder HE, kein Zuschlag, keine Rücknahme möglich
Straight shank according to DIN 6535 HB or HE, no extra charge, no withdrawal possible

→ K

Kühlkanal
internal coolant

GFS

Vollhartmetall-Gewindefräser für Innengewinde

UNF-Feingewinde ASME B1.1

Ausführung: 2 x D, 45° Senkfase, Zylinderschaft und Rechtsspiralnuten

Solid carbide thread milling cutters for internal threads

Unified national fine thread ASME B1.1
Specification: 2 x D, 45° chamfer for countersinking, straight shank and right hand spiral flutes

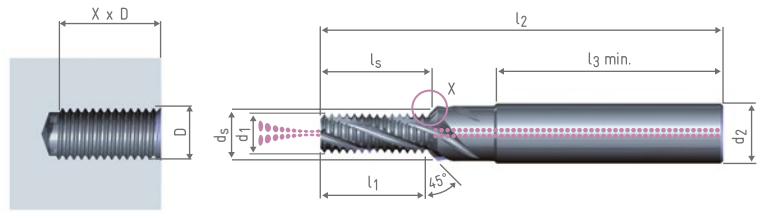
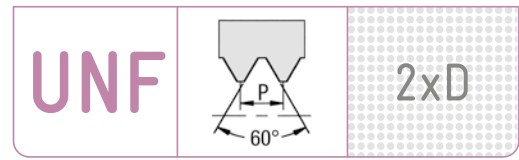
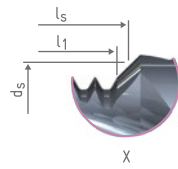

→HA (Zyl.-Schaft nach DIN 6535, Straight shank according to DIN 6535)

ORDER-CODE → GFS									→ 2 x D KT	
D	P Gg/1" tpi	l ₁	l ₂	l _{3 min.}	d ₂	d _s	l _s	Z Nuten- zahl No. of flutes	TiCN	
↓									Art.-Nr.	€
UNF Nr. 10	32	10,70	54	36	6	5,1	11,3	3	304960	172,00
UNF Nr. 12	28	12,20	54	36	6	5,8	13,0	3	304961	172,00
UNF 1/4"	28	14,05	62	36	8	6,7	14,8	3	304875	187,00
UNF 5/16"	24	17,40	74	40	10	8,3	18,3	3	304876	210,00
UNF 3/8"	24	20,60	80	45	12	10,0	21,6	4	304877	234,00
UNF 7/16"	20	24,70	80	45	12	11,7	25,9	4	304878	234,00
UNF 1/2"	20	27,25	90	45	14	13,3	28,5	4	304879	331,00
UNF 9/16"	18	30,30	102	48	16	15,0	31,6	4	304880	361,00
UNF 5/8"	18	33,10	102	48	18	16,7	34,5	4	304881	454,00



Zyl.-Schaft nach DIN 6535 HB oder HE, kein Zuschlag, keine Rücknahme möglich
Straight shank according to DIN 6535 HB or HE, no extra charge, no withdrawal possible



M
MF
MJ
EG M

G
Rc, R
Pg

UNC
UNF
UN
UNJF

NPT
NPTF

M
MF
M keg.
M taper

G
BSW
BSF
DIN 477
R, BA, Pg

UNC
UNF
UNEF
UN, UNS

NPSM
NPT
NPTF
Tr, Rd

M
MF

G
BSW
BSF
R, Pg
MF-EL

UNC, UNF
UNEF
UN, UNS
UNJC
UNJF

NPT
NPTF
Tr
EG

GFS

Vollhartmetall-Gewindefräser für Innengewinde

UNF-Feingewinde ASME B1.1

Ausführung: 2,5 x D, 45° Senkfase, Zylinderschaft und Rechtsspiralnuten

Solid carbide thread milling cutters for internal threads

Unified national fine thread ASME B1.1

Specification: 2.5 x D, 45° chamfer for countersinking, straight shank and right hand spiral flutes

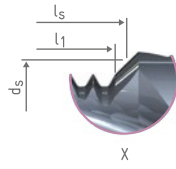

UNF

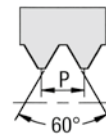

2,5xD

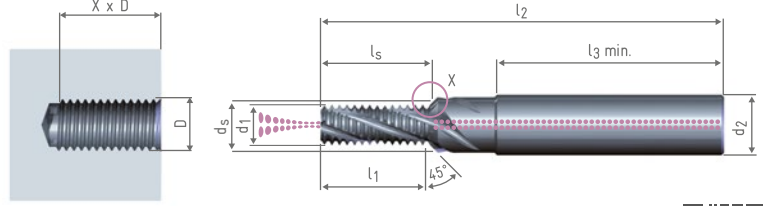

→ HA (Zyl.-Schaft nach DIN 6535, Straight shank according to DIN 6535)

ORDER-CODE → GFS									→ 2,5 x D KT	
D	P Gg/1" tpi	l ₁	l ₂	l _{3 min.}	d ₂	d _s	l _s	Z Nuten- zahl No. of flutes	TiCN	
↓									Art.-Nr.	€
UNF Nr. 10	32	12,30	54	36	6	5,1	12,9	3	310236	181,00
UNF Nr. 12	28	14,00	54	36	6	5,8	14,8	3	310237	181,00
UNF 1/4"	28	16,75	62	36	8	6,7	17,6	3	310238	189,00
UNF 5/16"	24	20,60	74	40	10	8,3	21,5	3	310239	221,00
UNF 3/8"	24	24,85	80	45	12	10,0	25,8	4	310240	246,00
UNF 7/16"	20	28,55	80	45	12	11,7	29,7	4	310241	246,00
UNF 1/2"	20	32,35	90	45	14	13,3	33,5	4	310242	349,00
UNF 9/16"	18	35,95	102	48	16	15,0	37,3	4	310243	381,00
UNF 5/8"	18	40,15	102	48	18	16,7	41,6	4	310244	479,00

3 x D auf Anfrage

3 x D on request

→ HB



→ HE

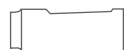

Zyl.-Schaft nach DIN 6535 HB oder HE, kein Zuschlag, keine Rücknahme möglich
Straight shank according to DIN 6535 HB or HE, no extra charge, no withdrawal possible

→ K

Kühlkanal
internal coolant

GFM

Vollhartmetall-Gewindefräser für Innengewinde

UN-Gewinde ASME B1.1

Ausführung: Zylinderschaft mit Kühlkanal und Rechtspiralnuten

Solid carbide thread milling cutters for internal threads

Unified national thread ASME B1.1

Specification: straight shank with internal coolant and right hand spiral flutes

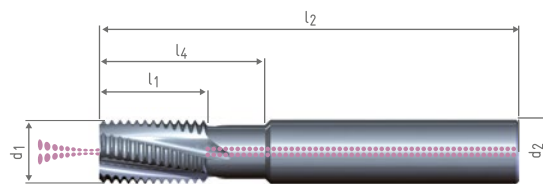
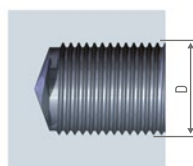

→HA (Zyl.-Schaft nach DIN 6535, Straight shank according to DIN 6535)

ORDER-CODE → GFM UN								T		
d ₁ Fräser Nenn-Ø Cutter nom. Ø ↓	P Gg/1" tpi ↓	D≥ für Gew - Ø for thread Ø	l ₂	l ₁	d ₂	l ₄ Nutz- länge use length	Z Nuten- zahl No. of flutes	TiCN	Art.-Nr.	€
10	32	1/2"	70	16	10	25	4		306351	276,00
10	24	1/2"	70	16	10	25	4		311013	230,00
12	24	5/8"	80	20	12	31	4		311014	274,00
12	20	11/16"	80	20	12	31	4		311015	274,00
12	18	5/8"	80	20	12	31	4		304865	250,00
12	16	5/8"	80	20	12	31	4		301094	250,00
12	10	3/4"	80	20	12	31	4		311034	286,00
16	24	13/16"	90	25	16	40	5		311016	347,00
16	20	13/16"	90	25	16	40	5		311017	330,00
16	18	7/8"	90	25	16	40	5		311018	312,00
16	16	7/8"	90	25	16	40	5		301317	312,00
16	14	7/8"	90	25	16	40	5		301145	317,00
16	12	7/8"	90	25	16	40	5		301214	322,00
16	10	7/8"	90	25	16	40	5		311021	320,00
20	20	1"	105	33	20	50	5		311022	442,00
20	18	1"	105	33	20	50	5		311023	434,00
20	16	1"	105	33	20	50	5		311024	434,00
20	12	1"	105	33	20	50	5		301596	438,00
20	8	1"	105	33	20	50	5		304866	458,00

Beachten Sie den kleinsten fräsbaren Gewindedurchmesser D≥

Caution - please look at the smallest thread diameter D≥ for the GFM tool system

→ HB

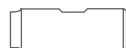

→ HE

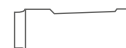

Zyl.-Schaft nach DIN 6535 HB oder HE, kein Zuschlag, keine Rücknahme möglich
Straight shank according to DIN 6535 HB or HE, no extra charge, no withdrawal possible



M
MF
MJ
EG M

G
Rc, R
Pg

UNC
UNF
UN
UNJF

NPT
NPTF



M
MF
M keg.
M taper

G
BSW
BSF
DIN 477
R, BA, Pg

UNC
UNF
UNEF
UN, UNS

NPSM
NPT
NPTF
Tr, Rd



M
MF

G
BSW
BSF
R, Pg
MF-EL

UNC, UNF
UNEF
UN, UNS
UNJC
UNJF

NPT
NPTF
Tr
EG

GFT SHARK

Vollhartmetall-Dreiprofilgewindefräser für Innengewinde

UN-Gewinde ASME B1.1

Ausführung: 3 x D, 3 volle Gewindeprofile
Zylinderschaft, ≥ UNC Nr.8 mit Kühlkanal, Linksspiralnuten

Solid carbide thread milling cutters with three rings of teeth for internal threads

Unified national thread ASME B1.1
Specification: 3 x D, 3 complete thread profiles
Straight shank, ≥ UNC Nr.8 with internal coolant, left hand spiral flutes

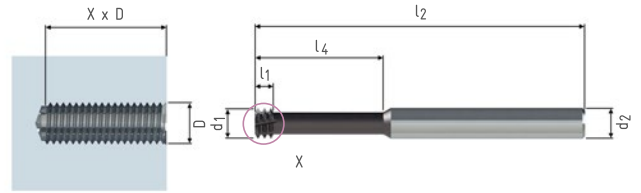
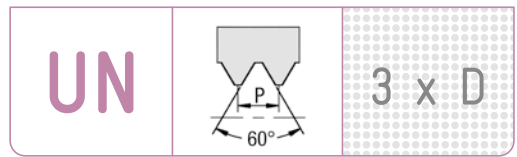

→ HA (Zyl-Schaft nach DIN 6535, Straight shank according to DIN 6535)

ORDER-CODE → GFT SHARK UN								3 x D	
P Gg/1" tpi ↓	UNC	UNF	l ₁	l ₂	l ₄ Nutz- länge use length	d ₂	z Nuten- zahl No. of flutes	ALTiCrN	
								Art.-Nr.	€
64	Nr.1	Nr.2*	1,15	39	5,8	3	4	312806	109,00
56	Nr.2	Nr.3*	1,31	39	6,8	3	4	312807	109,00
40	Nr.4		1,84	39	9,0	3	4	312808	109,00
40	Nr.5	Nr.6*	1,84	39	10,0	3	4	312809	109,00
32	Nr.6		2,30	39	11,0	3	4	312810	109,00

* 2,5 x D

* 2,5 x D

ORDER-CODE → GFT SHARK UN								3 x D K	
P Gg/1" tpi ↓	UNC	UNF	l ₁	l ₂	l ₄ Nutz- länge use length	d ₂	z Nuten- zahl No. of flutes	ALTiCrN	
								Art.-Nr.	€
32	Nr.8		2,30	54	13,0	6	6	312811	116,00
32		Nr.10	2,30	54	15,0	6	6	312812	116,00
28		1/4"	2,66	58	19,6	6	6	312813	116,00
24	Nr.10/Nr.12*		3,06	54	15,2	6	6	312814	116,00
20	1/4"		3,68	58	19,7	6	6	312815	116,00

* 2,5 x D

* 2,5 x D

→ HB



→ HE



Zyl-Schaft nach DIN 6535 HB oder HE, kein Zuschlag, keine Rücknahme möglich
Straight shank according to DIN 6535 HB or HE, no extra charge, no withdrawal possible

→ K

Kühlkanal
internal coolant

GF

Vollhartmetall-Gewindefräser für Innengewinde

NPT-Kegeliges Amerikanisches Rohrgewinde ASME B1.20.1

Kegel 1:16, Für Gewinde mit Dichtmittel
Ausführung: Zylinderschaft mit Kühlkanal und Rechtsspiralnuten

Solid carbide thread milling cutters for internal threads

American Standard taper pipe thread ASME B1.20.1
Taper 1:16, for threads used with jointing compound
Specification: straight shank with internal coolant and right hand spiral flutes

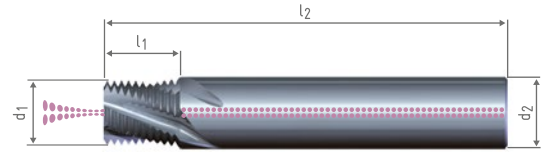
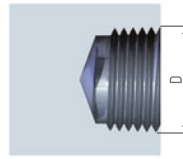

→HA (Zyl.-Schaft nach DIN 6535, Straight shank according to DIN 6535)

ORDER-CODE → GF →						blank uncoated		T TiCN		F TiAlN	
D	P Gg/1" tpi	l ₁	l ₂	d ₂	z Nuten- zahl No. of flutes	Art.-Nr.	€	Art.-Nr.	€	Art.-Nr.	€
NPT 1/16"	27	9,86	62	8	3	310038	188,00	310039	214,00	310040	214,00
NPT 1/8"	27	9,90	64	8	4	300114	188,00	301468	214,00	300251	214,00
NPT 1/4"	18	19,04	72	12	4	300121	242,00	300531	268,00	300252	268,00
NPT 3/8"	18	14,82	80	14	4	300250	260,00	300532	287,00	300107	287,00
NPT 1/2"	14	19,12	80	14	4	300802	321,00	301122	350,00	302233	350,00

→ HB



→ HE

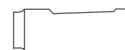

Zyl.-Schaft nach DIN 6535 HB oder HE, kein Zuschlag, keine Rücknahme möglich
Straight shank according to DIN 6535 HB or HE, no extra charge, no withdrawal possible



M
MF
MJ
EG M

G
Rc, R
Pg

UNC
UNF
UN
UNJF

NPT
NPTF

M
MF
M keg.
M taper

G
BSW
BSF
DIN 477
R, BA, Pg

UNC
UNF
UNEF
UN, UNS

NPSM
NPT
NPTF
Tr, Rd

M
MF

G
BSW
BSF
R, Pg
MF-EL

UNC, UNF
UNEF
UN, UNS
UNJC
UNJF

NPT
NPTF
Tr
EG

GFM

Vollhartmetall-Gewindefräser für Innengewinde

NPT-Kegeliges Amerikanisches Rohrgewinde ASME B1.20.1

Kegel 1:16, Für Gewinde mit Dichtmittel
Ausführung: Zylinderschaft mit Kühlkanal und Rechtsspiralnuten

Solid carbide thread milling cutters for internal threads

American Standard taper pipe thread ASME B1.20.1
Taper 1:16, for threads used with jointing compound
Specification: straight shank with internal coolant and right hand spiral flutes

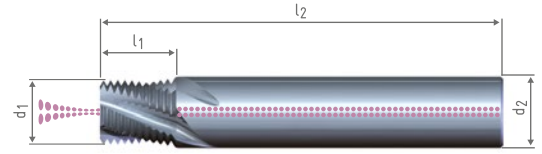
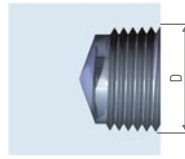

→HA (Zyl.-Schaft nach DIN 6535, Straight shank according to DIN 6535)

ORDER-CODE → GFM NPT →							blank uncoated		T TiCN		F TiAlN	
d ₁ Fräser Nenn-Ø Cutter nom. Ø	P Gg/1" tpi	D _z für Gew - Ø for thread Ø	l ₁	l ₂	d ₂	z Nuten- zahl No. of flutes	Art.-Nr.	€	Art.-Nr.	€	Art.-Nr.	€
14,5	14	NPT 1/2"	19,05	90	16	5	300336	408,00	301101	439,00	300340	439,00
18,5	11,5	NPT 1"	23,19	90	20	5	300337	500,00	301102	535,00	300341	535,00

Beachten Sie den kleinsten fräsbaren Gewindedurchmesser D_z

Caution - please look at the smallest thread diameter D_z for the GFM tool system

GF

Vollhartmetall-Gewindefräser für Innengewinde

NPTF-Kegeliges Amerikanisches Rohrgewinde ANSI B1.20.3

Kegel 1:16, Für Gewinde ohne Dichtmittel
Ausführung: Zylinderschaft mit Kühlkanal und Rechtsspiralnuten

Solid carbide thread milling cutters for internal threads

American Standard taper pipe thread ANSI B1.20.3
Taper 1:16, For threads used without jointing compound
Specification: Straight shank with internal coolant and right hand spiral flutes

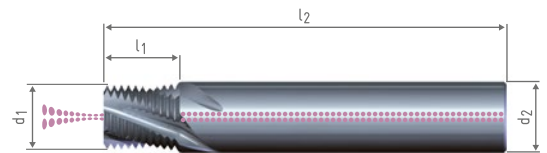
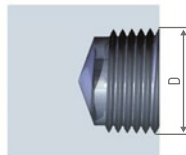
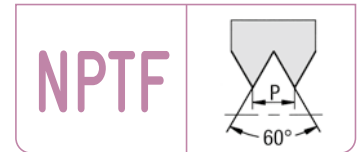

→HA (Zyl.-Schaft nach DIN 6535, Straight shank according to DIN 6535)

ORDER-CODE → GF →							blank uncoated		T TiCN		F TiAlN	
D	P Gg/1" tpi	l ₁	l ₂	d ₂	z Nuten- zahl No. of flutes	Art.-Nr.	€	Art.-Nr.	€	Art.-Nr.	€	
NPTF 1/16"	27	9,86	62	8	3	310042	207,00	310043	234,00	310044	234,00	
NPTF 1/8"	27	9,90	64	8	4	301837	207,00	301297	234,00	301840	234,00	
NPTF 1/4"	18	19,04	72	12	4	300255	266,00	304503	293,00	301841	293,00	
NPTF 3/8"	18	14,82	80	14	4	300254	286,00	310041	315,00	300256	315,00	
NPTF 1/2"	14	19,10	80	14	4	303494	353,00	305035	384,00	303501	384,00	



Zyl.-Schaft nach DIN 6535 HB oder HE, kein Zuschlag, keine Rücknahme möglich
Straight shank according to DIN 6535 HB or HE, no extra charge, no withdrawal possible



GFM

Vollhartmetall-Gewindefräser
für Innengewinde

NPTF-Kegeliges Amerikanisches
Rohrgewinde ANSI B1.20.3

Kegel 1:16, Für Gewinde ohne Dichtmittel
Ausführung: Zylinderschaft mit Kühlkanal
und Rechtspiralnuten

**Solid carbide thread milling cutters
for internal threads**

American Standard taper pipe thread ANSI B1.20.3
Taper 1:16, for threads used without jointing compound
Specification: straight shank with internal coolant
and right hand spiral flutes

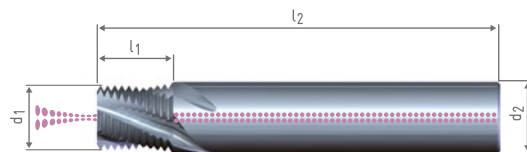
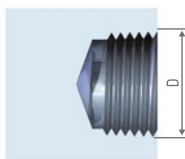
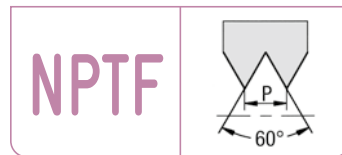

→HA (Zyl.-Schaft nach DIN 6535, Straight shank according to DIN 6535)

ORDER-CODE → GFM NPTF →							T		F			
d ₁ Fräser Nenn-Ø Cutter nom. Ø	P Gg/1" tpi	D≥ für Gew - Ø for thread Ø	l ₁	l ₂	d ₂	z Nuten- zahl No. of flutes	blank uncoated	TiCN	TiAlN			
							Art.-Nr.	€	Art.-Nr.	€	Art.-Nr.	€
14,5	14	NPTF 1/2"	19,05	90	16	5	300338	428,00	304998	460,00	301849	460,00
18,5	11,5	NPTF 1"	23,14	90	20	5	301848	525,00	305036	571,00	300339	571,00

Beachten Sie den kleinsten fräsbaren Gewindedurchmesser D≥

Caution - please look at the smallest thread diameter D≥
for the GFM tool system

→ HB



→ HE

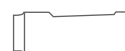

Zyl.-Schaft nach DIN 6535 HB oder HE, kein Zuschlag, keine Rücknahme möglich
Straight shank according to DIN 6535 HB or HE, no extra charge, no withdrawal possible



M
MF
MJ
EG M

G
Rc, R
Pg

UNC
UNF
UN
UNJF

NPT
NPTF



M
MF
M keg.
M taper

G
BSW
BSF
DIN 477
R, BA, Pg

UNC
UNF
UNEF
UN, UNS

NPSM
NPT
NPTF
Tr, Rd



M
MF

G
BSW
BSF
R, Pg
MF-EL

UNC, UNF
UNEF
UN, UNS
UNJC
UNJF

NPT
NPTF
Tr
EG



M
MF
MJ
EG M

G
Rc, R
Pg

UNC
UNF
UN
UNJF

NPT
NPTF



M
MF
M keg.
M taper

G
BSW
BSF
DIN 477
R, BA, Pg

UNC
UNF
UNEF
UN, UNS

NPSM
NPT
NPTF
Tr, Rd



M
MF

G
BSW
BSF
R, Pg
MF-EL

UNC, UNF
UNEF
UN, UNS
UNJC
UNJF

NPT
NPTF
Tr
EG

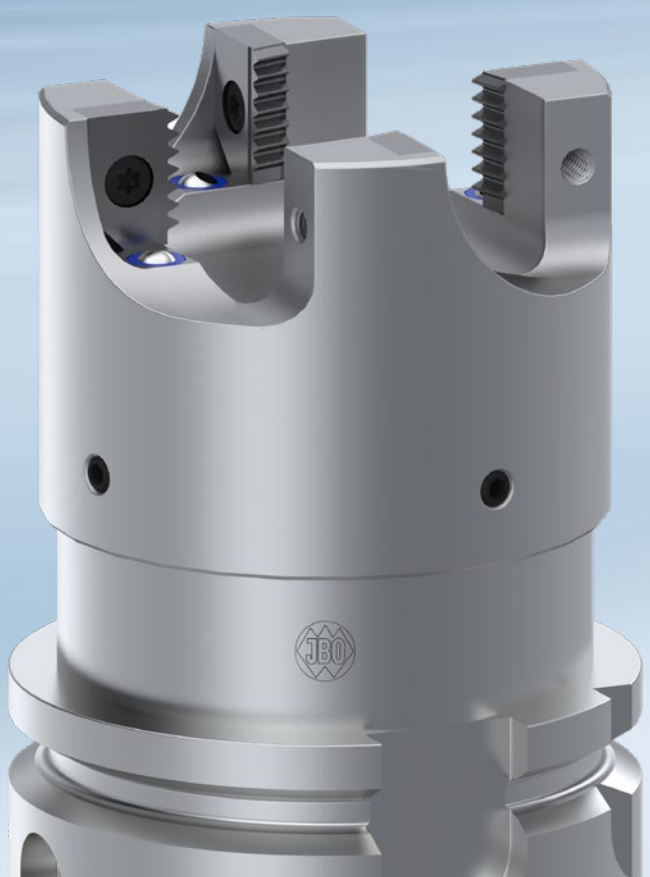



Glockengewindefräser Kombinationswerkzeuge

Shell Type Thread Milling Cutters
Combination Tools



M
MF
MJ
EG M

G
Rc, R
Pg

UNC
UNF
UN
UNJF

NPT
NPTF



M
MF
M keg.
M taper

G
BSW
BSF
DIN 477
R, BA, Pg

UNC
UNF
UNEF
UN, UNS

NPSM
NPT
NPTF
Tr, Rd



M
MF

G
BSW
BSF
R, Pg
MF-EL

UNC, UNF
UNEF
UN, UNS
UNJC
UNJF

NPT
NPTF
Tr
EG



M
MF
MJ
EG M

G
Rc, R
Pg

UNC
UNF
UN
UNJF

NPT
NPTF



M
MF
M keg.
M taper

G
BSW
BSF
DIN 477
R, BA, Pg

UNC
UNF
UNEF
UN, UNS

NPSM
NPT
NPTF
Tr, Rd



M
MF

G
BSW
BSF
R, Pg
MF-EL

UNC, UNF
UNEF
UN, UNS
UNJC
UNJF

NPT
NPTF
Tr
EG

Glockengewindefräser Kombinationswerkzeuge

Shell Type Thread Milling Cutters
Combination Tools

Effektive Produktionskosteneinsparung

Effective production cost saving

Seite/page 120

Aufnahmetypen

Types of adaptors

Seite/page 120

Glockengewindefräser GFG

Shell Type Thread Milling Cutters GFG

Seite/page 121

Glockengewindefräser GFG-WFE/GFG-WP

Shell Type Thread Milling Cutters GFG-WFE/GFG-WP

Seite/page 122

Kombinationswerkzeuge

Combination Tools

Seite/page 124



M
MF
MJ
EG M

G
Rc, R
Pg

UNC
UNF
UN
UNJF

NPT
NPTF



M
MF
M keg.
M taper

G
BSW
BSF
DIN 477
R, BA, Pg

UNC
UNF
UNEF
UN, UNS

NPSM
NPT
NPTF
Tr, Rd



M
MF

G
BSW
BSF
R, Pg
MF-EL

UNC, UNF
UNEF
UN, UNS
UNJC
UNJF

NPT
NPTF
Tr
EG

Effektive Produktionskosteneinsparung

Effective production cost saving

Einsparpotentiale in der spanenden Fertigung Savings in cutting production

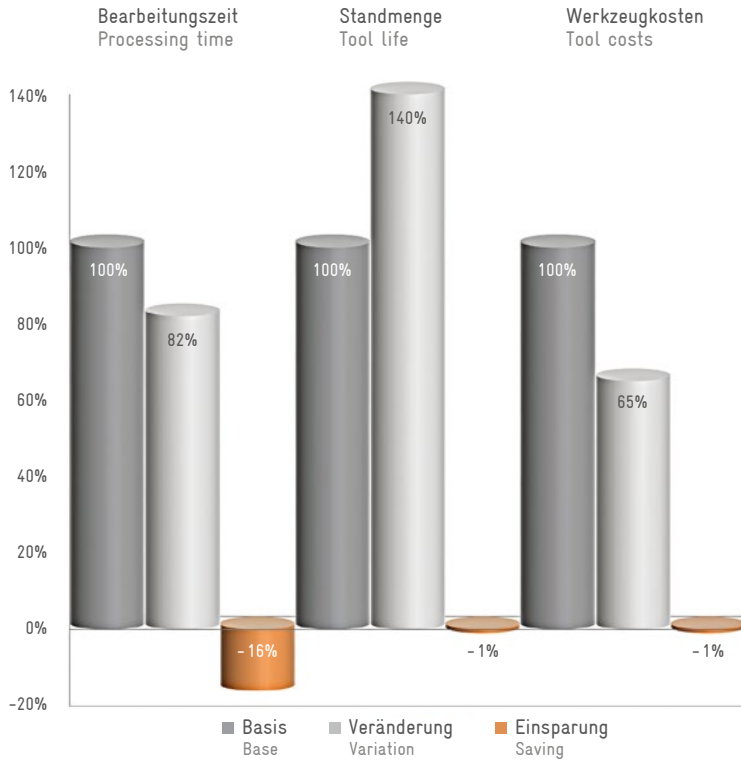

Zur Einsparung von Produktionskosten stehen mehrere Möglichkeiten zur Verfügung. Diese haben unterschiedlich starke Effekte auf die Gesamtkostenentstehung.

Aus dem Diagramm ist ersichtlich, dass eine Einsparung an der Bearbeitungszeit ein wesentlich höheres Einsparpotential bietet, als eine Standzeiterhöhung oder Einsparung bei den Werkzeugkosten.

Durch das Zusammenfassen verschiedener Prozesse in einem Werkzeug (Kombinationswerkzeug) oder das Optimieren der Werkzeuge (Glockengewindefräser mit größerer Schneidenzahl) kann unabhängig von technologischen Grenzen die Bearbeitungszeit gesenkt werden.

Manufacturing costs can be reduced in several ways. These have different marked effects on the resulting total costs.

It can be seen from the graph, that a saving of machining time potentially offers substantially saving in tooling costs.

Irrespective of the limits set by technology, machining time can be reduced by combining various operations with a combination tool or by optimised tool design, such as that of the shell type thread milling cutters with its additional cutting tool inserts.

Aufnahmetypen

Types of adaptors

Die Grundtypen unserer Kombinationswerkzeuge/Glockengewindefräser werden in Monoblockbauweise hergestellt. Diese können mit unterschiedlichen maschinenseitigen Aufnahmen ausgestattet werden.

The basic types of our combination tools and shell type thread milling cutters are of unitary construction. These tools can be fitted with various adaptors for machine spindles.

Hohlschaftkegel HSK
DIN 69893

Steilkegelschaft BT
DIN ISO 7388-2

Steilkegelschaft SK
DIN 69871

Zylinderschaft
DIN 1835

Polygonschaftkegel Capto
ISO/DIS 26623

HSK taper shank
DIN 69893

ISO taper shank BT
DIN ISO 7388-2

ISO taper shank
DIN 69871

Parallel shank
DIN 1835

Polygon taper shank
ISO/DIS 26623



Auf Anfrage bieten wir auch andere Aufnahmetypen an!
On request, we can also supply other types of adaptors!



Glockengewindefräser GFG

Shell Type Thread Milling Cutters GFG

Vorteile

- Verkürzung der Bearbeitungszeiten
- Sehr hohe Standmengen erreichbar
- Sehr hohe Gewindequalität
- Gewindemaßhaltigkeit beeinflussbar
- Rechts- und Linksgewinde mit den gleichen Einsätzen herstellbar
- Durch Wechsel der Einsätze können mit demselben Werkzeug unterschiedliche Steigungen und Profile erzeugt werden
- Einstellbare exakte Gewindetiefe
- Optimale Kühlschmierung
- Optionale Entfernung des unvollständigen ersten Gewindeganges

Advantages

- Reduction of cutting time
- Very long tool life
- Excellent thread quality
- Thread dimensional stability influenceable
- Right-hand and left-hand threads can be produced with the same inserts
- By changing the inserts, different pitches and profiles can be produced with the same tool
- Adjustable exact thread depth
- Optimum coolant supply
- Optional removal of the incomplete first thread

Ablaufschritte

Sequence of operations

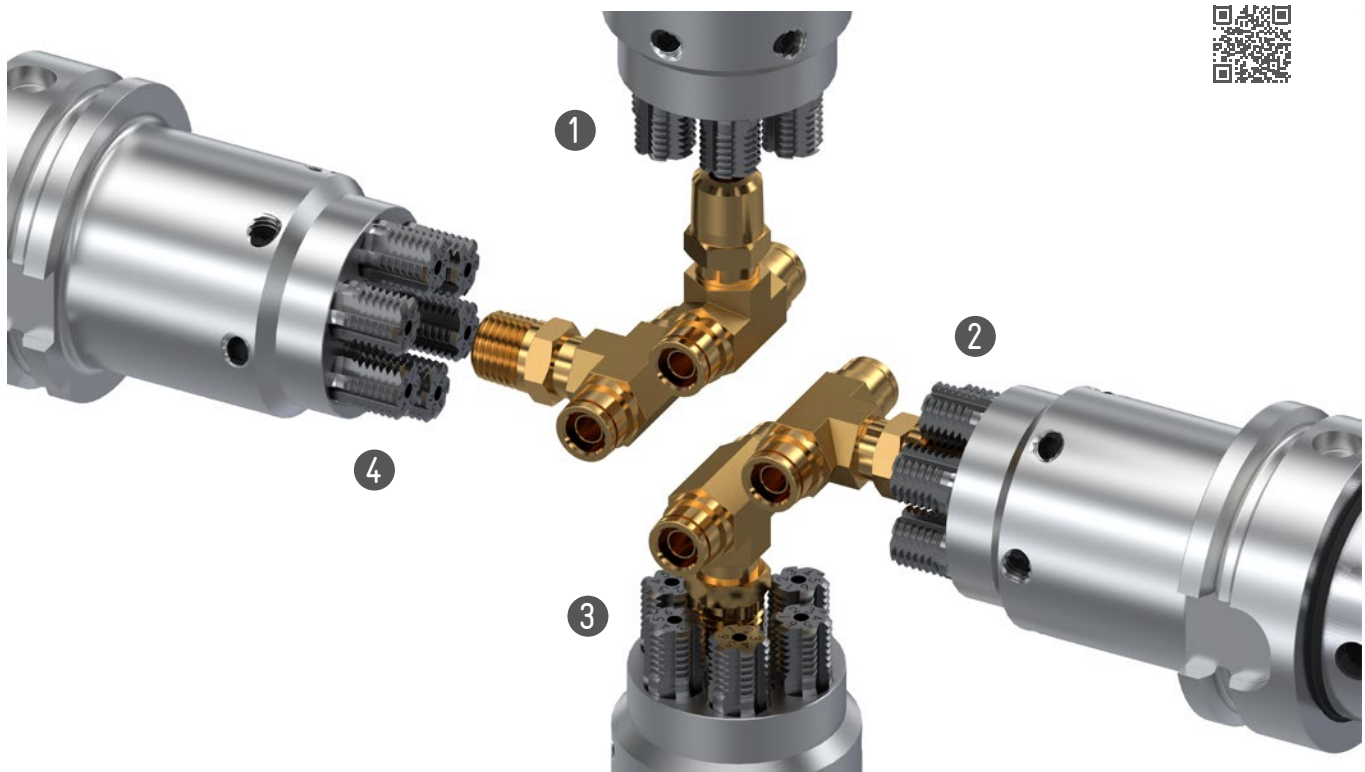

- 1 Werkzeug fährt auf Startposition zentrisch über den Bolzen
- 2 Werkzeug fährt auf Starttiefe zum Gewindefräsen
- 3 Fräsen des Gewindes
- 4 Verfahren auf Startposition und beenden des Bearbeitungsvorganges

- 1 Tool moves centrally over the bolt to the starting position
- 2 Tool approaches starting depth for thread milling
- 3 Thread milling
- 4 Returning to the start position and ending the machining process cycle

Glockengewindefräser GFG-WFE

Shell Type Thread Milling Cutters GFG-WFE

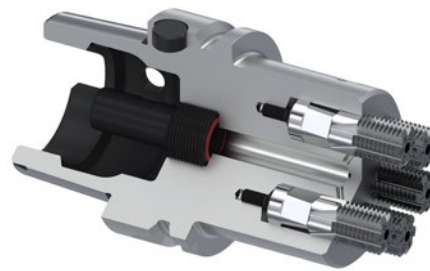

Spezieller Glockengewindefräser für den Einsatz in der Massenfertigung. Aufgrund der ausgeklügelten Konstruktion kann jeder Wechselfräseinsatz bis zu sechs Schneiden zur Verfügung stellen. Dadurch können mit diesem Werkzeug hervorragende Standmengen realisiert werden.

Diese Werkzeuge werden für jeden Anwendungsfall unserer Kunden speziell und in enger Abstimmung ausgelegt.

Special shell type thread milling cutter for use in the mass production. Due to its concept each insert can provide up to six cutting edges. So with this tool an excellent tool life can be realized.

These tools are specially designed for every application in close coordination with our customers.

Vorteile

- Reduzierung der Fertigungszeiten durch höhere Schnittwerte (Vorschübe)
- Höhere Standzeit durch höhere Anzahl von Schneiden
- Hochwertige Gewindeoberfläche durch stabilere Bauweise
- Einsetzbar für nahezu jedes Gewinde oder Profil
- Besonders geeignet für die Stahlbearbeitung in der Großserienproduktion
- Deutlich geringere Werkzeugkosten pro Stück
- Die Einsätze können, wie gewohnt, mehrfach nachgeschliffen werden

Advantages

- Shorter machining time due to higher feed rates
- Increased tool life due to larger number of cutting edges
- Higher grade thread surface texture due to rugged construction
- Suitable for nearly any thread or profile
- Particularly advantageous for long run production of steel components
- Distinctly lower tooling costs per workpiece
- The inserts can be reground several times as usual

Glockengewindefräser GFG-WP

Shell Type Thread Milling Cutters GFG-WP



Universell einsetzbarer Glockengewindefräser mit Wechselplatten, der sich durch optimale Zugänglichkeit und Einfachheit auszeichnet. Viele verschiedene Wechselplatten mit verschiedenen Gewindeprofilen sind ab Lager verfügbar.

Wechselplatten (Schneidenlänge 14 und 20 mm) sind für M-Gewinde, G-Gewinde und UN-Gewinde verfügbar. Preis und Lagerbestand auf Anfrage.

Vorteile

- Hervorragend geeignet für die Bearbeitung von Buntmetallen
- Kostengünstige Lösung durch geometrisch einfache Wechselplatten
- Optimale Zugänglichkeit für das Auswechseln der Wechselplatten
- Einsetzbar für nahezu jedes Gewinde oder Profil
- Besonders geeignet für die Bearbeitung leicht zerspanbarer Werkstoffe in der Serienproduktion
- Deutlich geringere Werkzeugkosten pro Stück als bei VHM-Fräswerkzeugen
- Die Wendepplatten können, wie gewohnt, mehrfach nachgeschliffen werden

Advantages

- Excellent for machining of non-ferrous metals
- Cost-effective solution by geometrically simple milling inserts
- Optimum accessibility for the replacement of milling inserts
- Suitable for nearly any thread or profile
- Particularly suitable for processing easy to machine materials in serial production
- Significantly lower cost per piece than solid carbide milling tools
- The inserts can be reground several times as usual

Universal shell type thread milling cutter with indexable inserts, outstanding for its optimum accessibility and simplicity. A wide range of different indexable inserts for various thread profiles is available ex stock.

Indexable inserts (14 and 20 mm long cutting edge) are available for M threads, G pipe threads and UN threads. Price and detail of current stocks are available on request.

Berechnung der Einzelgewindekosten für die Anschlussgewinde an der Hochdruckpumpe und den Injektoren

Calculation of the costs per thread for the connection threads on the high-pressure pump and the injectors

Gewindeabmessung		Thread dimension	
	Durchmesser Diameter	Steigung Pitch	
	[mm]		
M 14 x 1,5	14,00	1,5	

Werkzeugabmessungen		Tool dimensions	
	Schneiden-Ø Cutting-Ø	Anzahl der Einsätze im Halter No. of inserts in the holder	Schneidenzahl pro Einsatz No. of cutting edges per insert
	[mm]		
Glockengewindefräser GFG-WFE Shell type thread milling cutter GFG-WFE	18,00	6	6
Glockengewindefräser Wettbewerber Shell type thread milling cutter competitor	18,00	4	2
VHM-Gewindefräser Solid carbide thread milling cutter	16,00	1	5

Werkzeuginformationen		Tool informations				
	Halterkosten Holder costs	Nutzungen vor Erneuerung Uses before renewal	Kosten pro neuem Einsatz Costs per new insert	Nachschleifkosten Resharpening costs	Anzahl der Nachschleife Number of resharp	
	[€]		[€]	[€]		
Glockengewindefräser GFG-WFE Shell type thread milling cutter GFG-WFE	400,00	20	150,00	30,00	2	
Glockengewindefräser Wettbewerber Shell type thread milling cutter competitor	400,00	20	50,00	25,00	2	
VHM-Gewindefräser Solid carbide thread milling cutter	100,00	100	70,00	20,00	3	

Werkzeugkosten pro Gewinde		Tool costs per thread		
	Standmenge Tool life quantity	Werkzeugkosten Tool costs	Werkzeugkosten pro Gewinde Tool costs per thread	
Glockengewindefräser GFG-WFE Shell type thread milling cutter GFG-WFE	72.000	1.320,00	1,83	
Glockengewindefräser Wettbewerber Shell type thread milling cutter competitor	24.000	460,00	1,92	
VHM-Gewindefräser Solid carbide thread milling cutter	16.000	134,00	0,84	

Maschinenkosten pro Gewinde		Machine costs per thread				
	Schnittge- schwindigkeit Cutting speed	Vorschub pro Zahn Feed rate per tooth	Zähnezahl im Eingriff No. of teeth in engagement	Bearbeitungsdauer Tooling time	Maschinen- stundensatz Machine cost	Maschinenkosten pro Gewinde Machine costs per thread
	v_c [m/min]	f_z [mm]	z	[sec]	[€]	[cent]
Glockengewindefräser GFG-WFE Shell type thread milling cutter GFG-WFE	140	0,08	6	2,89	70,00	5,61
Glockengewindefräser Wettbewerber Shell type thread milling cutter competitor	100	0,06	4	8,08	70,00	15,72
VHM-Gewindefräser Solid carbide thread milling cutter	100	0,05	5	6,90	70,00	13,41

Gesamtkosten pro Gewinde		Total costs per thread		
	Werkzeugkosten pro Gewinde Tool costs per thread	Maschinenkosten pro Gewinde Machine costs per thread	Gesamtkosten pro Gewinde Total costs per thread	
Glockengewindefräser GFG-WFE Shell type thread milling cutter GFG-WFE	1,83	5,61	7,45	
Glockengewindefräser Wettbewerber Shell type thread milling cutter competitor	1,92	15,72	17,63	
VHM-Gewindefräser Solid carbide thread milling cutter	0,84	13,41	14,25	

Kombinationswerkzeuge für Plan-, Senk-, Bohr- und Gewindefräsbearbeitung

Combination Tools for spotfacing, counterboring, drilling and thread milling in a single cycle



Ablaufschritte

- 1 Werkzeug fährt auf Startpunkt zentrisch über die Gewindeposition
- 2 Bohren des Kernloches
- 3 Senken
- 4 Entspanen
- 5 Gewindefräsen
- 6 Verfahren auf Startposition und beenden des Bearbeitungsvorganges



Sequence of operations

- 1 Tool moves to starting point centered over the thread position
- 2 Core hole drilling
- 3 Chamfering
- 4 Ejection of chips
- 5 Thread milling
- 6 Moving to the start position and ending the machining process

Vorteile

Dieses Werkzeug ist ein Kombinationswerkzeug für die Plan-, Senk-, Bohr- und Gewindefräsbearbeitung. Durch die Zusammenlegung verschiedener Bearbeitungsoperationen in einem Werkzeugsystem ergeben sich für den Anwender erhebliche Zeiteinsparungen durch Reduzierung der Nebenzeiten wie Werkzeugwechsel und Verfahwege.

Advantages

This tool combines spotfacing, counterboring, drilling and thread milling in a single cycle. The combination of different machining operations in one tool system results in considerable time savings for the user by reducing non-productive times such as tool changes and traverse paths.

Kombinationswerkzeuge

Combination Tools

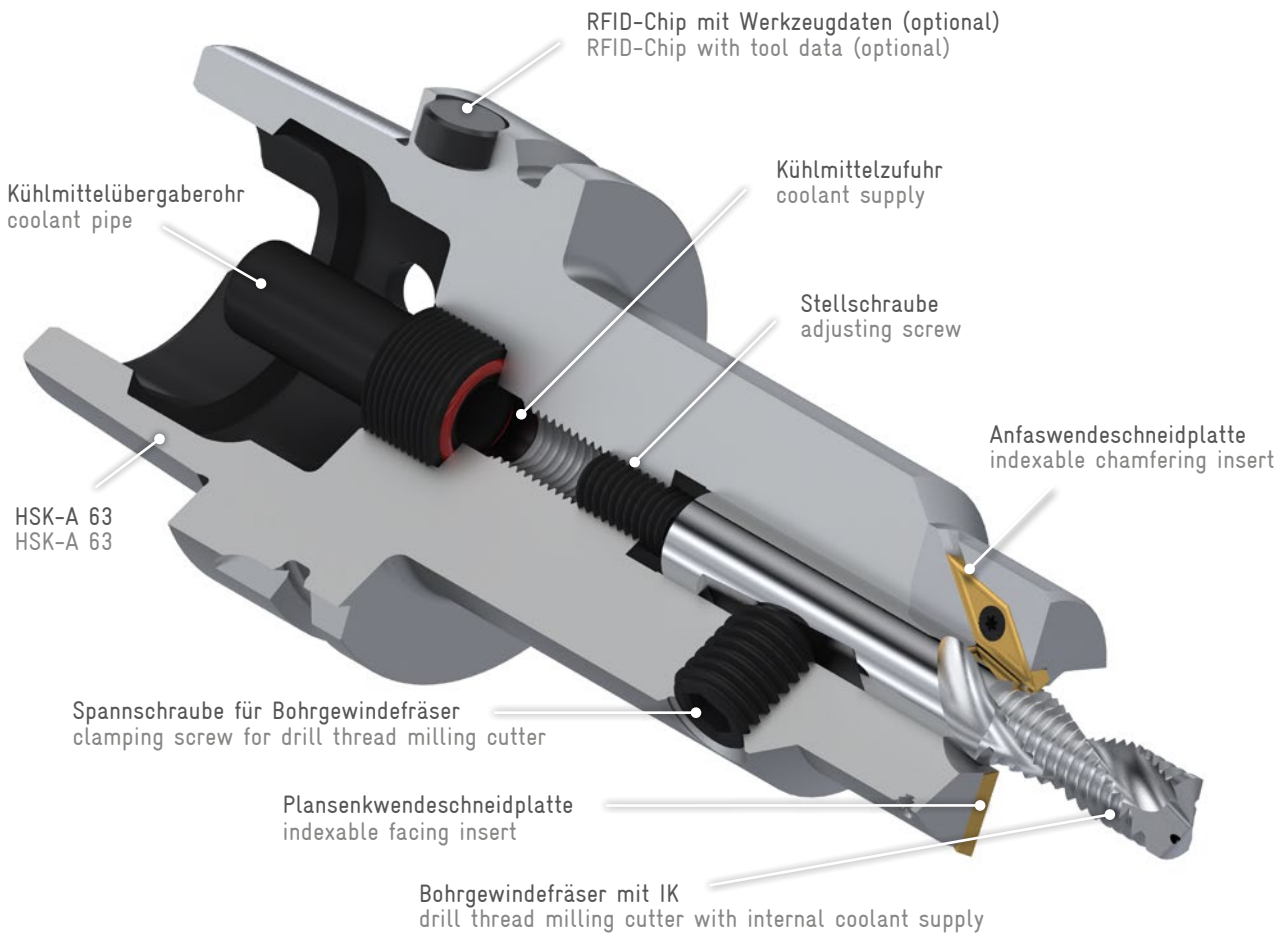

Beispiele von Kombinationswerkzeugen

Examples for Combination Tools

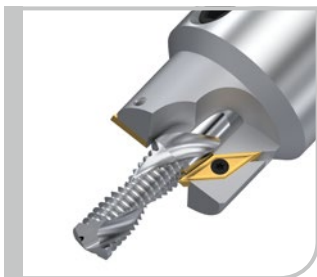

Kombinationswerkzeug mit Bohrgewindefräser M 12 2,5xD, IK Plansenk- und Anfasplatte

Combination tool with M 12 2.5xD drill thread milling cutter, including internal cooling supply and indexable facing and chamfering inserts



Kombinationswerkzeug mit Bohrgewindefräser M 16 x 1,5 mit IK-Austritt in den Spannuten und drei PKD-bestückten Konturplatten

Combination tool with drill thread milling cutter M 16 x 1.5 with coolant exit in the flutes and three PCD-tipped contour inserts

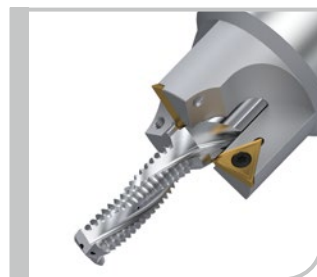

Kombinationswerkzeug mit Bohrgewindefräser M 10 IK und drei Plansenkplatten

Combination tool with drill thread milling cutter M 10 including internal cooling supply and three indexable facing inserts



M
MF
MJ
EG M

G
Rc, R
Pg

UNC
UNF
UN
UNJF

NPT
NPTF



M
MF
M keg.
M taper

G
BSW
BSF
DIN 477
R, BA, Pg

UNC
UNF
UNEF
UN, UNS

NPSM
NPT
NPTF
Tr, Rd



M
MF

G
BSW
BSF
R, Pg
MF-EL

UNC, UNF
UNEF
UN, UNS
UNJC
UNJF

NPT
NPTF
Tr
EG





PKD-, CVD-D- und PcBN-Werkzeuge

PCD, CVD-D and PcBN Tools

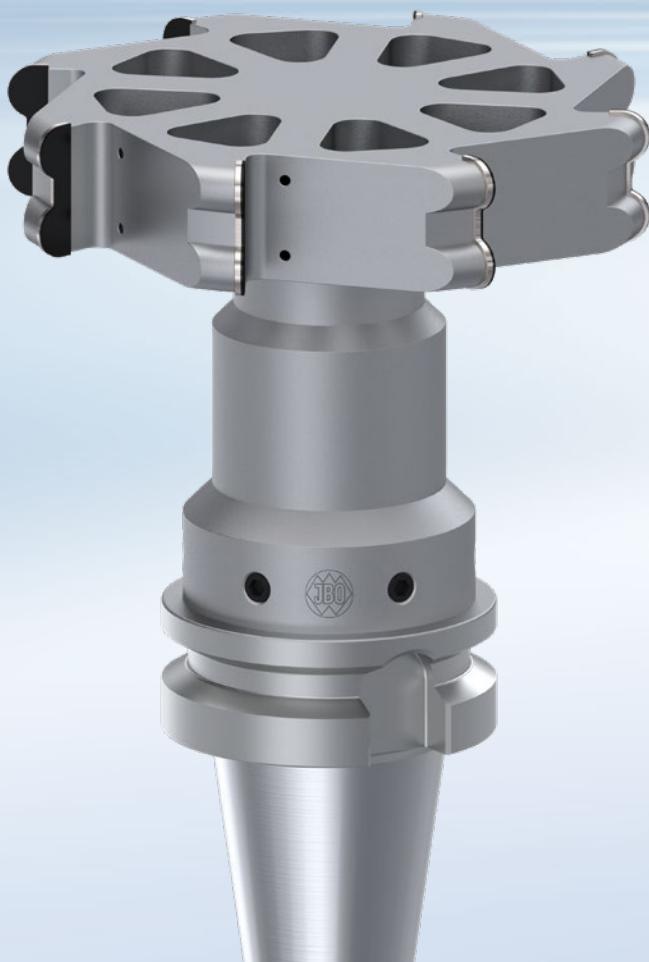

M
MF
MJ
EG M

G
Rc, R
Pg

UNC
UNF
UN
UNJF

NPT
NPTF



M
MF
M keg.
M taper

G
BSW
BSF
DIN 477
R, BA, Pg

UNC
UNF
UNEF
UN, UNS

NPSM
NPT
NPTF
Tr, Rd



M
MF

G
BSW
BSF
R, Pg
MF-EL

UNC, UNF
UNEF
UN, UNS
UNJC
UNJF

NPT
NPTF
Tr
EG



M
MF
MJ
EG M

G
Rc, R
Pg

UNC
UNF
UN
UNJF

NPT
NPTF



M
MF
M keg.
M taper

G
BSW
BSF
DIN 477
R, BA, Pg

UNC
UNF
UNEF
UN, UNS

NPSM
NPT
NPTF
Tr, Rd



M
MF

G
BSW
BSF
R, Pg
MF-EL

UNC, UNF
UNEF
UN, UNS
UNJC
UNJF

NPT
NPTF
Tr
EG

PKD-, CVD-D- und PcBN-Werkzeuge

PCD, CVD-D and PcBN Tools

Allgemeine Information

General Information

Seite/page 130

Werkzeuge mit PKD-, CVD-D- und PcBN-Schneiden

Tools with PCD, CVD-D and PcBN Cutting Edges

Seite/page 131

Kunden-individuelle Sonderwerkzeuge

Special Client-Specific Tools

Seite/page 132

Projektierung von kundenspezifischen Komplettbearbeitungsaufgaben

Project planning of client-specific complete machining tasks

Seite/page 134

PKD-PF REVOLUTION Planfräser

PCD-PF REVOLUTION Face Milling Cutter

Seite/page 136

PKD-PF/PKD-PF Eco Planfräser

PCD-PF/PCD-PF Eco Face Milling Cutters

Seite/page 138

PFAD-HSK/PFAD-SK Aufsteckfräsdorne

PFAD-HSK/PFAD-SK Shell End Mill Arbors

Seite/page 140

PKD-SF Schaftfräser

PCD-SF End Milling Cutters

Seite/page 141

Anwendungsempfehlungen und Schnittdaten

Reference of application and cutting data

Seite/page 142



M
MF
MJ
EG M

G
Rc, R
Pg

UNC
UNF
UN
UNJF

NPT
NPTF



M
MF
M keg.
M taper

G
BSW
BSF
DIN 477
R, BA, Pg

UNC
UNF
UNEF
UN, UNS

NPSM
NPT
NPTF
Tr, Rd



M
MF

G
BSW
BSF
R, Pg
MF-EL

UNC, UNF
UNEF
UN, UNS
UNJC
UNJF

NPT
NPTF
Tr
EG

Allgemeine Information

General Information

PKD

PKD (Polykristalliner Diamant) ist ein Verbundschneidstoff bestehend aus synthetisch hergestellten Diamanten, die in einer Metallmatrix versintert sind. Durch unterschiedliche Körnungen und Bindungsanteile lassen sich die mechanischen Eigenschaften dieses Schneidstoffes gezielt verändern. Der Diamantanteil beträgt hierbei je nach Sorte zwischen 90 % und 95 %.

Die Kombination aus Wärmeleitfähigkeit, Härte und Biegebruchfestigkeit macht PKD zu einem hervorragenden Schneidstoff für die Bearbeitung von NE-Metallen und modernen Verbundwerkstoffen.

CVD-D

CVD-D (Chemical Vapour Deposition Diamant) entsteht durch die chemische Gasphasenabscheidung von Kohlenstoff und ist ebenfalls ein polykristalliner Diamant. Im Vergleich zu PKD ist CVD-D jedoch binderlos und besitzt einen Diamantanteil von über 99 %. Dies macht ihn zu einem der härtesten Schneidstoffe der Welt. Durch die noch bessere Wärmeleitfähigkeit und Härte eignet sich CVD-D für die Zerspanung von Aluminium ($Si > 10\%$), Hartmetallen, Keramiken, Faserverbundwerkstoffen und Metallmatrix-Verbundwerkstoffen (MMC).

Mit CVD-D kann unter optimalen Bedingungen eine Standzeitverbesserung, im Vergleich zu PKD, um das 10-fache erreicht werden.

PcBN

PcBN (Polykristallines kubisches Bornitrid) ist ähnlich wie PKD ein Verbundschneidstoff. Allerdings werden hier PcBN-Körner in einer keramischen oder metallischen Matrix versintert. Durch eine Vielzahl von unterschiedlichen Kombinationen in der Zusammensetzung erfordern PcBN Schneidstoffe ein hohes Maß an Know-how bei der Auswahl und Verarbeitung.

Im Anwendungsgebiet unterscheidet sich PcBN aufgrund seiner grundverschiedenen physikalisch-mechanischen Eigenschaften sehr stark von jenem der Diamantwerkzeuge. Im Gegensatz zu den zuvor genannten Diamantschneidstoffen besitzt PcBN eine höhere Warmfestigkeit, höhere Zähigkeit und keine Affinität zu Kohlenstoff. Daher ist PcBN zur Bearbeitung von Eisenguss-Werkstoffen, gehärteten Stählen sowie Nickelbasislegierungen geeignet.

PCD

PCD (polycrystalline Diamond) is a composite cutting material consisting of synthetically produced diamonds sintered in a metal matrix. The mechanical properties of this cutting material can be changed in a targeted manner through different grain sizes and bond proportions. Depending on the grade, the diamond content is between 90 % and 95 %.

The combination of thermal conductivity, hardness and flexural strength makes PCD an excellent cutting material for machining non-ferrous metals and modern composite materials.

CVD-D

CVD-D (Chemical Vapour Deposition Diamond) is produced by the chemical vapour deposition of carbon and is also a polycrystalline diamond. Compared to PCD, however, CVD-D is binderless and has a diamond content of over 99 %. This makes it one of the hardest cutting materials in the world. Due to its even better thermal conductivity and hardness, CVD-D is suitable for cutting aluminium ($Si > 10\%$), hard metals, ceramics, fibre composites and metal matrix composites (MMC).

Under optimal conditions, CVD-D can achieve a 10-fold improvement in tool life, compared to PCD.

PcBN

PcBN (Polycrystalline Cubic Boron Nitride) is, similar to PCD, a composite cutting material. However, here PcBN grains are sintered in a ceramic or metallic matrix. Due to a multitude of different composition combinations, PcBN cutting materials require a high degree of know-how in selection and processing.

Due to its fundamentally different physical and mechanical properties, PcBN differs greatly from diamond tools in its field of application. In contrast to the previously mentioned diamond cutting materials, PcBN has a higher heat resistance, higher toughness and no affinity to carbon. Therefore, PcBN is suitable for machining cast iron materials, hardened steels and nickel-based alloys.

Werkzeuge mit PKD-, CVD-D- und PcBN-Schneiden

„Hightech made in Germany“. Von der Entwurfsplanung in enger Zusammenarbeit mit unseren Kunden über die Auswahl des optimalen Schneidstoffs für die jeweilige Anwendung, bis hin zur Produktion auf unseren Laserbearbeitungsmaschinen der neuesten Generation; alles findet im Hause JBO am Produktionsstandort Albstadt statt. Unsere Teams in der Entwicklung/Konstruktion und im technischen Vertrieb finden die optimale Lösung für Ihr Fertigungsvorhaben.

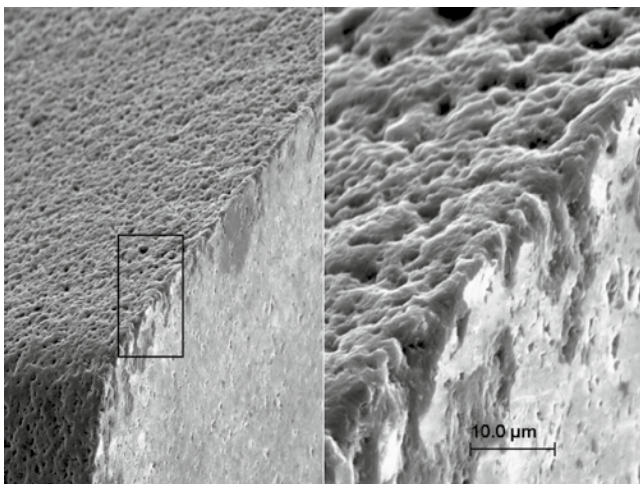

Drahterodierte Schneidkante / EDM cutting edge

Im Vergleich mit den herkömmlichen Verfahren zur Herstellung von schneidstoffbestückten Werkzeugen sticht die hervorragende Qualität der superscharfen Schneidkante hervor. Diese zeichnet sich durch eine sehr geringe Schartigkeit und minimalste Schneidkantenverrundung aus. So sind für unsere Kunden eine lange Standzeit, eine hohe Prozesssicherheit und ein höchst wirtschaftlicher Werkzeugeinsatz gewährleistet.

Unser Portfolio im Bereich der superharten Schneidstoffe wird zusätzlich noch durch die Tatsache abgerundet, dass mit der von uns eingesetzten Technologie ebenfalls Schneidstoffe eingesetzt werden können, welche durch konventionelle Technologien nicht bearbeitet werden können. Hierzu zählen neben dem sogenannten CVD-D (Diamantwerkstoff ohne Kobalt als Binder) auch die PKD-Sorten mit einem sehr hohen Diamantanteil und vor allem PKD-Mischsorten aus groben und feinen Körnungen, da bei der Laserbearbeitung das Diamantkorn geschnitten wird.

Tools with PCD, CVD-D and PcBN Cutting Edges

“High-tech made in Germany“. All activities take place at the JBO production location at Albstadt, ranging from design planning in close cooperation with customers and selection of optimal cutting materials for specific applications, to the production on our laser processing machines of the very latest generation. Our teams in development/construction and technical sales find the optimal solution for your production plans.

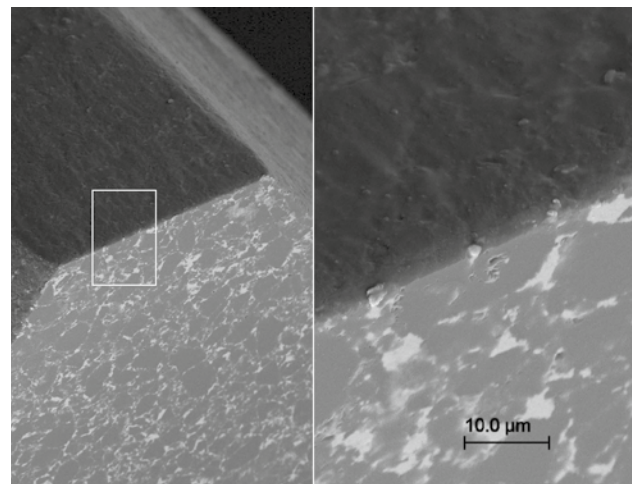

Lasergeschnittene Schneidkante / laser cut cutting edge

Compared to the conventional methods used to manufacture tools tipped with cutting materials, the exceptional quality of the super-sharp cutting edge is instantly recognizable. It is characterized by minimal micro chipping and cutting edge rounding. This means our customers are ensured long tool life, a high level of process safety and maximum economy with regard to tool use.

Our portfolio in the area of super hard cutting materials is rounded off by the fact that the technology we use enables cutting materials to be used that cannot be machined with standard technologies. These include for example the so called CVD-D (diamond material without cobalt as a binder), the PCD types with a very high diamond ratio, and primarily PCD hybrid variants with finer and coarser grain sizes, as the diamond grain is cut during laser processing.



M
MF
MJ
EG M

G
Rc, R
Pg

UNC
UNF
UN
UNJF

NPT
NPTF



M
MF
M keg.
M taper

G
BSW
BSF
DIN 477
R, BA, Pg

UNC
UNF
UNEF
UN, UNS

NPSM
NPT
NPTF
Tr, Rd



M
MF

G
BSW
BSF
R, Pg
MF-EL

UNC, UNF
UNEF
UN, UNS
UNJC
UNJF

NPT
NPTF
Tr
EG

Kunden-individuelle Sonderwerkzeuge

Special Client-Specific Tools

Die jahrzehntelange Erfahrung von JBO in der Anpassung oder Weiter- bzw. Neuentwicklung von Produkten an die spezifischen Anforderungen unserer Kunden weltweit, prädestiniert JBO dafür, effiziente und qualitativ hochwertige PKD-Sonderlösungen zu konzipieren und innerhalb kürzester Zeit umzusetzen. Vom Entwurf bis zum Einsatz begleiten wir unsere Kunden, um eine bestmögliche Lösung für die stetig wachsenden Aufgaben und Herausforderungen am Markt zu erarbeiten.

Durch die hohe Flexibilität unserer Fertigung ist es möglich Werkzeuge mit allen gängigen Schnittstellen zu produzieren. Darunter fallen beispielsweise Werkzeugspannsysteme nach DIN 69893 (HSK-Hohlschaftkegel), DIN 69871 (SK-Steilkegel), JIS B 6339 (MAS 403 BT), ISO 26623-1 (Polygonaler Hohl-schaftkegel) und DIN 6535 HA, HB, HE (Zylinderschäfte aus Hartmetall und Stahl).

JBO's decades of experience in the adaption or further respectively new development of products to the specific requirements of our customers worldwide, predestines JBO for the efficient and high quality design of PCD special solutions and to implement them on short notice. We accompany our customers from draft to application, in order to compile the best possible solution for the steady growing tasks and challenges on the market.

Due to the high flexibility of our production we have the possibility to manufacture tools with all current interfaces. Thereunder belong for example tool clamping systems acc. DIN 69893 (HSK hollow shank cone), DIN 69871 (SK steep cone), JIS B 6339 (MAS 403 BT), ISO 26623-1 (polygonal hollow shank taper) and DIN 6535 HA, HB, HE (carbide and steel straight shanks).



- 1 PKD Scheibenfräser für die simultane Herstellung von Einstichen in einem Kurbelgehäuse.

PCD side milling cutter for the simultaneous production of grooves in a crankcase.

- 2 PKD Stufenreibahle für die Bearbeitung einer Ventilführung.

PCD stepped reamer for machining a valve guide.

- 3 PKD Feinbohrwerkzeug mit zusätzlichen Frässhneiden für die Herstellung von Bohrungsfreistichen.

PCD fine drilling tool with additional milling blades for the production of drill relief grooves.

- 4 PKD Glockenstechwerkzeug für die gleichzeitige Bearbeitung von Innen- und Außenkontur eines Fittings.

PCD bell form burring tool (grooving tool) for the simultaneous machining of internal and external fitting contours.

- 5 PKD Glockenstechwerkzeug für die Vor- bzw. Endbearbeitung einer Sanitärarmatur.

PCD bell form burring tool (grooving tool) for the pre- and end machining of a sanitary fitting.

- 6 PKD Entgratwerkzeug für die Präzisionsentgratung des Gewindefangs.

PCD deburring tool for the precision deburring of the thread start.



4



5



6



M
MF
MJ
EG M



G
Rc, R
Pg

UNC
UNF
UN
UNJF

NPT
NPTF



M
MF
M keg.
M taper

G
BSW
BSF
DIN 477
R, BA, Pg

UNC
UNF
UNEF
UN, UNS

NPSM
NPT
NPTF
Tr, Rd



M
MF

G
BSW
BSF
R, Pg
MF-EL

UNC, UNF
UNEF
UN, UNS
UNJC
UNJF

NPT
NPTF
Tr
EG

Projektierung von kundenspezifischen Komplettbearbeitungsaufgaben

Project planning of client-specific complete machining tasks

Durch unsere Erfahrung mit PKD-, CVD-D- und PcBN-Werkzeugen, welche wir seit 2013 im eigenen Haus produzieren, bieten wir unseren Kunden die Möglichkeit, alle Werkzeuge für die komplette Bearbeitung komplexer Teile zu projektieren und herzustellen. Das größte Augenmerk liegt dabei auf der Optimierung der Prozesszeiten durch den Einsatz von PKD, CVD-D oder PcBN als Schneidstoff sowie dem Zusammenfassen von mehreren Bearbeitungen in einem Werkzeug. Durch die direkte Kommunikation unserer Konstrukteure mit den zuständigen Fachkräften unserer Kunden und den damit verbundenen, regelmäßigen Austausch von Ideen, entstehen regelmäßig große Synergieeffekte.

Thanks to our experience with PCD, CVD-D and PcBN tools, which we have been producing in-house since 2013, we can offer our customers the possibility of designing and manufacturing all tools for the complete machining of complex parts. The main focus is on optimising process times by using PCD, CVD-D or PcBN as cutting material as well as combining several machining operations in one tool. Direct communication between our design engineers and the responsible specialists at our customers and the associated regular exchange of ideas regularly result in major synergy effects.

1 PKD-Aufbohrwerkzeug zur gleichzeitigen Bohrungsinnen- sowie Gehäuseaußenbearbeitung.

PCD drilling tool for simultaneous internal bore and external housing machining.

2 PKD-Glockenwerkzeug zur Fertigbearbeitung von Innen- und Außeneinstichen.

PCD bell form tool for finishing internal and external recesses.

3 PKD-Scrollfräser mit Achswinkel für einen vibrationsarmen Schnitt.

PCD scroll cutter with axis angle for a low-vibration cut.



4+5 PKD-Stufenwerkzeug zur Bohrungsinnen-, Planspiegel- sowie Rückwärtssenkbearbeitung.

PCD step tool for internal bore, spot face and reverse countersink machining.

6 Mehrstufiges PKD-Aufbohrwerkzeug zur Bohrungsinnen- sowie Fasbearbeitung.

Multi-stage PCD drilling tool for internal bore and chamfer machining.



4



5



6

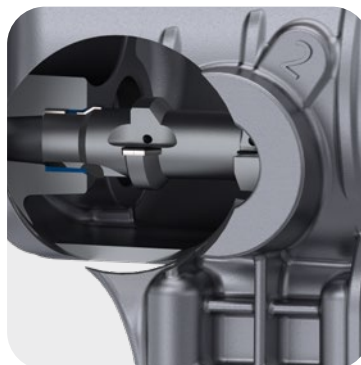
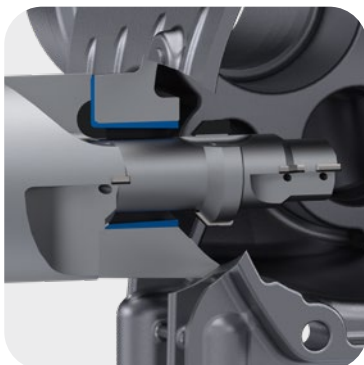

M
MF
MJ
EG M

G
Rc, R
Pg

UNC
UNF
UN
UNJF

NPT
NPTF



M
MF
M keg.
M taper

G
BSW
BSF
DIN 477
R, BA, Pg

UNC
UNF
UNEF
UN, UNS

NPSM
NPT
NPTF
Tr, Rd



M
MF

G
BSW
BSF
R, Pg
MF-EL

UNC, UNF
UNEF
UN, UNS
UNJC
UNJF

NPT
NPTF
Tr
EG

PKD-PF REVOLUTION Planfräser

PCD-PF REVOLUTION Face Milling Cutter

Stolz präsentieren wir die Weltneuheit im Bereich der Zerspanung mit PKD-Schneiden. Der REVOLUTION Planfräser ist das erste Werkzeug, das den Dreh raus hat. Die Schneiden des REVOLUTION sind nicht stoffschlüssig mit dem Träger verbunden. Kein Lot und kein Klebstoff wird verwendet. Deshalb wird auch keine Energie für das Erwärmen des Trägers zum Lötens oder zum Aushärten des Klebstoffs benötigt. Der REVOLUTION besitzt ein speziell entwickeltes Klemmsystem. Ein PKD-Zuschnitt mit einer kreisbogenförmigen Kontur bildet zusammen mit diesem Klemmsystem das Herzstück des REVOLUTION Planfräasers. Neben der kraftschlüssigen Befestigung der Schneiden, bieten diese Kreisbogenzuschnitte die Möglichkeit, durch einfaches Öffnen der Spannung und minimales Drehen der Schneiden im Gegenuhrzeigersinn mit kleinstmöglichem Schneidstoffverlust den Neuzustand der Schneide wiederherzustellen. Durch die Einfachheit des Systems ist eine deutlich kürzere Lieferzeit für nachgeschärfte Werkzeuge erreichbar. Durch den geringen Aufwand beim Nachschärfen oder Neubestücken sind die REVOLUTION Planfräser außerdem sehr kosteneffizient im Vergleich zu anderen Werkzeugen.

We proudly present the world's first in the field of machining with PCD cutting edges. The REVOLUTION face milling cutter is the first tool to get the hang of it. The cutting edges of the REVOLUTION are not bonded to the carrier. No solder or adhesive is used. Therefore, no energy is required to heat the carrier for soldering or to cure the adhesive. The REVOLUTION has a specially developed clamping system. A PCD blank with a circular arc-shaped contour, together with this clamping system, forms the heart of the REVOLUTION face mill. In addition to the force-locked fastening of the cutting edges, these circular arc blanks offer the possibility of restoring the cutting edge to its new condition by simply opening the clamping and minimally rotating the cutting edges counterclockwise with the least possible loss of cutting material. Due to the simplicity of the system, a significantly shorter delivery time for resharpened tools can be achieved. Due to the low effort required for resharpening or retooling, the REVOLUTION face milling cutters are also very cost-efficient compared to other tools.

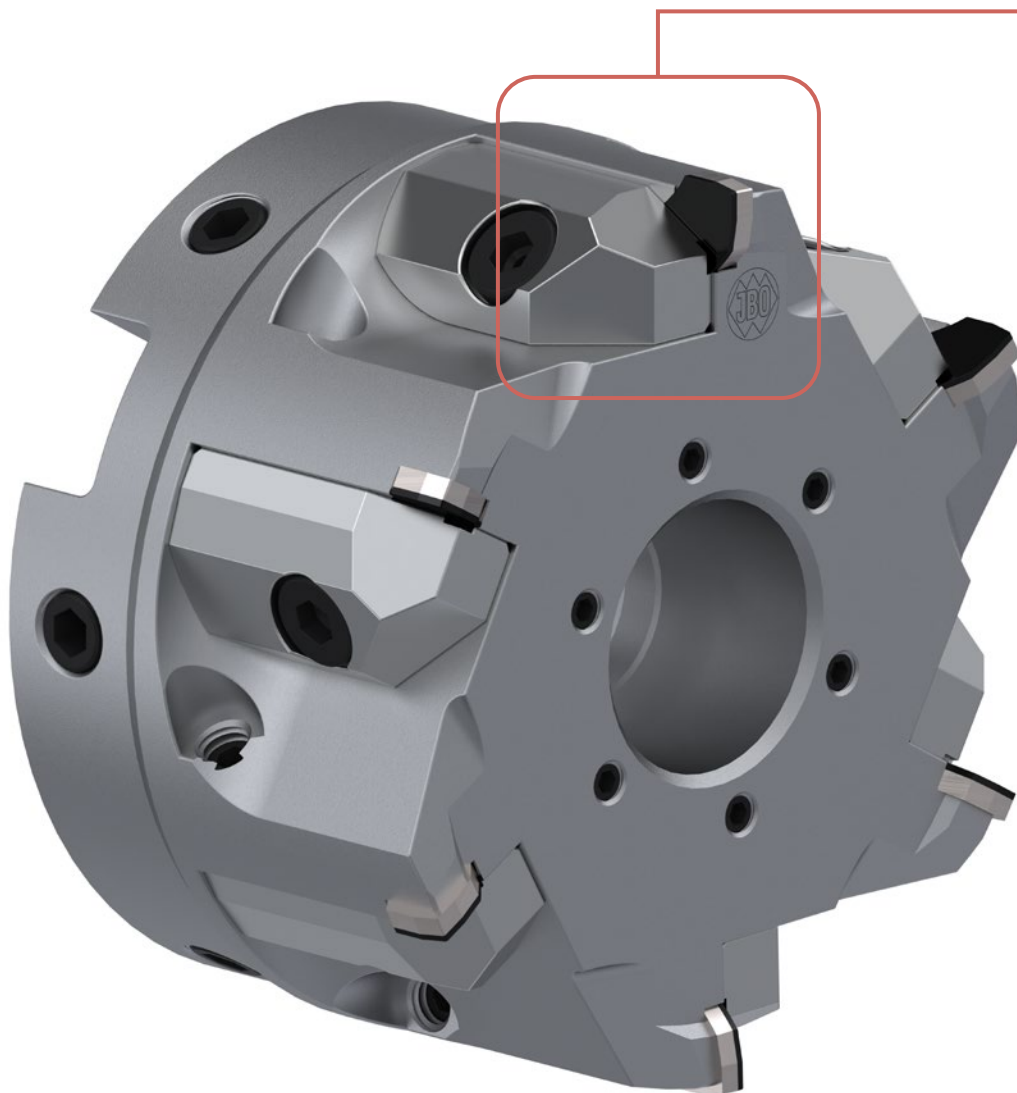



Vorteile

- Immer gleicher Schneiden- \varnothing und gleiche Schneidenlänge des Werkzeugs
- Schnelles „Erneuern“ der Schneidkante
- Umweltfreundlich
 - minimalster Verschleiß beim Schärfen
 - maximale Ausnutzung des PKD Schneidstoffes
 - keine Lötung der Schneide notwendig
 - kein Flussmittel
 - kein Hartlot
 - kein Strahlmittel
 - keine Reinigungsmittel
 - Einsparung an Energiekosten (CO₂-Einsparung)
- Keine Temperatureinwirkung auf den Schneidstoff
 - keine Schädigung von Diamant (Graphitisierung)
- Keine Temperatureinwirkung auf den Träger
 - keine Gefügeänderung/Festigkeitsänderung
- Optimale Kühlmittelverteilung an jede einzelne Schneide
- Variabel einsetzbar durch modularen Aufbau/Monoblockwerkzeuge auf Anfrage
- Diverse Schneideckengeometrien wählbar

Advantages

- Always the same cutting edge \varnothing and cutting edge length of the tool
- Quick „renewal“ of the cutting edge
- Environmentally friendly
 - minimal waste during sharpening
 - maximum utilisation of the PCD cutting material
 - no soldering of the cutting edge necessary
 - no flux
 - no braze
 - no blasting abrasive
 - no detergents
 - savings in energy costs (CO₂ savings)
- No temperature effect on the cutting material
 - no damage to diamond (graphitisation)
- No temperature effect on the carrier
 - no change in structure/strength
- Optimum coolant distribution to each individual cutting edge
- Variable use due to modular design/monobloc tools on request
- Various cutting edge geometries selectable



M
MF
MJ
EG M

G
Rc, R
Pg

UNC
UNF
UN
UNJF

NPT
NPTF



M
MF
M keg.
M taper

G
BSW
BSF
DIN 477
R, BA, Pg

UNC
UNF
UNEF
UN, UNS

NPSM
NPT
NPTF
Tr, Rd



M
MF

G
BSW
BSF
R, Pg
MF-EL

UNC, UNF
UNEF
UN, UNS
UNJC
UNJF

NPT
NPTF
Tr
EG

PKD-PF/PKD-PF Eco – Herausragende Oberflächen

PCD-PF/PCD-PF Eco – Outstanding surfaces



Die Werkzeuge der PKD-PF und PKD-PF Eco Serien werden mittels Lasertechnologie gefertigt. Dies bietet unseren Kunden den Vorteil, dass eine sehr niedrige Schartigkeit der Schneiden erzielt wird. Dies spiegelt sich in einer hervorragenden Oberflächengüte der gefrästen Oberflächen und den herausragenden, erzielbaren Standzeiten wider.

The tools of the PCD-PF and PCD-PF Eco series are manufactured using laser technology. This offers our customers the advantage that a very low chipping of the cutting edges is achieved. This is reflected in the excellent surface quality of the milled surfaces and the outstanding tool life that can be achieved.



Die PKD-PF Eco Serie ist eine konsequente Umsetzung der Kundenbedürfnisse. Diese Werkzeuge erreichen ebenfalls sehr hohe Standzeiten und überzeugen durch Ihren günstigen Preis. Auch das Nachschärfen oder Neubestücken der verschlissenen Schneiden und somit das Wiederherstellen des technischen Neuzustands der Werkzeuge ist kostenoptimiert.

The PCD-PF Eco series is a consistent conversion of customer requirements. These tools also achieve very long tool lives and are convincing due to their favourable price. The re-sharpening or re-tipping of worn cutting edges and thus the restoration of the tools to their new technical condition is also cost-optimised.

PKD-PF

Planfräser

PCD-PF Face Milling Cutters

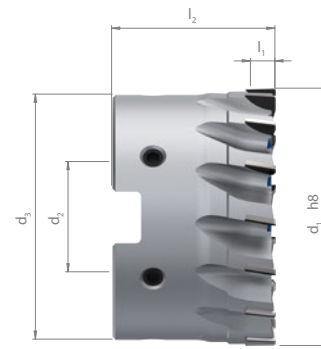
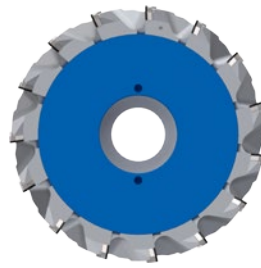

ORDER-CODE → PKD-PF →						B		L		K			
d ₁ Fräser Nenn-Ø Cutter nom. Ø ↓	d ₂	d ₃	l ₁	l ₂	z Zähne- zahl No. of teeth	Neuwerkzeug new tool		Neubestückung renew		Nacharbeit re-sharpening		Klemmschraube Clamping screw	
						Art.-Nr.	€	Art.-Nr.	€	Art.-Nr.	€	Art.-Nr.	€
32	16	32	6	32	6	650781	○					651010	○
40	16	40	6	32	9	650780	○					650778	○
50	22	48	6	36	12	650529	○					650537	○
63	27	60	6	40	15	650530	○					650538	○
80	27	60	6	45	18	650531	○					650539	○
100	32	78	6	50	21	650532	○					650540	○
125	40	89	6	56	27	650533	○					650541	○

Werkzeug montiert und gewuchtet - Zuschlag 35,00€
vorgewuchtet G6,3 - 8000 min⁻¹
○ am Lager, Preis auf Anfrage

tool assembled and balanced extra charge 35.00€
pre balanced G6.3 - 8000 min⁻¹
○ in stock, price on request

PKD-PF Eco

Planfräser

PCD-PF Eco Face Milling Cutters

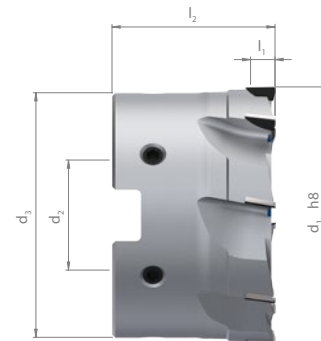
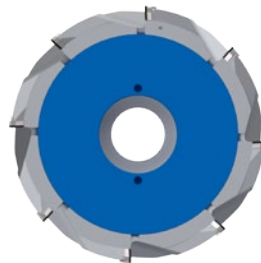

ORDER-CODE → PKD-PF Eco →						B		L		K			
d ₁ Fräser Nenn-Ø Cutter nom. Ø ↓	d ₂	d ₃	l ₁	l ₂	z Zähne- zahl No. of teeth	Neuwerkzeug new tool		Neubestückung renew		Nacharbeit re-sharpening		Klemmschraube Clamping screw	
						Art.-Nr.	€	Art.-Nr.	€	Art.-Nr.	€	Art.-Nr.	€
32	16	32	6	32	4	652264	○					651010	○
40	16	40	6	32	6	652265	○					650778	○
50	22	48	6	36	6	652266	○					650537	○
63	27	60	6	40	8	652267	○					650538	○
80	27	60	6	45	9	652268	○					650539	○
100	32	78	6	50	10	652269	○					650540	○
125	40	89	6	56	12	652270	○					650541	○

Werkzeug montiert und gewuchtet - Zuschlag 35,00€
vorgewuchtet G6,3 - 8000 min⁻¹
○ am Lager, Preis auf Anfrage

tool assembled and balanced extra charge 35.00€
pre balanced G6.3 - 8000 min⁻¹
○ in stock, price on request



PFAD-HSK

Aufsteckfräsdorne

HSK-A DIN 69882-3 Form B

Shell end mill arbors

HSK-A DIN 69882-3 Type B

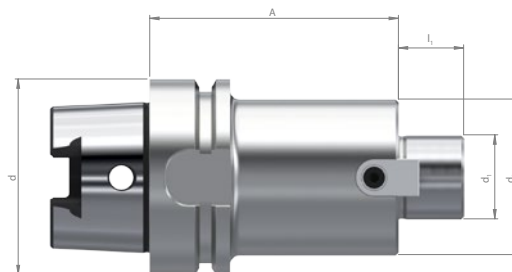

ORDER-CODE → PFAD-HSK →					A=100		A=160		K			
d ₁ Nenn-Ø nom. Ø	HSK-A	A	l ₁	d ₂	Art.-Nr.	€	Art.-Nr.	€	Art.-Nr.	€	Kühlmittelrohr Coolant tube	
↓												
16	63	50	17	40	750147	○	750148	○	750163	○	750182	○
22	63	50	19	50	750131	○	750149	○	750164	○	750182	○
27	63	60	21	60	750132	○	750150	○	750165	○	750182	○
32	63	60	24	78	750133	○	750151	○	750166	○	750182	○
40	63	60	27	89	750134	○	750152	○	750167	○	750182	○
16	100	50	17	40	750153	○	750158	○	750168	○	750183	○
22	100	50	19	50	750154	○	750159	○	750169	○	750183	○
27	100	60	21	60	750155	○	750160	○	750170	○	750183	○
32	100	60	24	78	750156	○	750161	○	750171	○	750183	○
40	100	60	27	89	750157	○	750162	○	750172	○	750183	○

PFAD-SK

Aufsteckfräsdorne

SK-AD DIN 69871 Form AD

Shell end mill arbors

SK-AD DIN 69871 Type AD

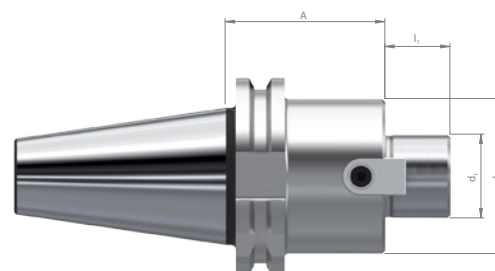

ORDER-CODE → PFAD-SK →					AB				
d ₁ Nenn-Ø nom. Ø	SK-A	A	l ₁	d ₂	Art.-Nr.	€	Art.-Nr.	€	DIN 69872 Form A Anzugsbolzen Retention knob
↓									
16	40-AD	35	17	40	750173	○	750184	○	750184
22	40-AD	35	19	50	750174	○	750184	○	750184
27	40-AD	35	21	60	750175	○	750184	○	750184
32	40-AD	50	24	80	750176	○	750184	○	750184
40	40-AD	50	27	89	750177	○	750184	○	750184
22	50-AD	35	19	50	750178	○	750185	○	750185
27	50-AD	40	21	60	750179	○	750185	○	750185
32	50-AD	50	24	80	750180	○	750185	○	750185
40	50-AD	50	27	89	750181	○	750185	○	750185

○ am Lager, Preis auf Anfrage

○ in stock, price on request

PKD-SF

Schaftfräser

3° positiver Achswinkel
seitliche Innenkühlung

PCD-SF End Milling Cutters

3° positive axis angle
lateral internal coolant

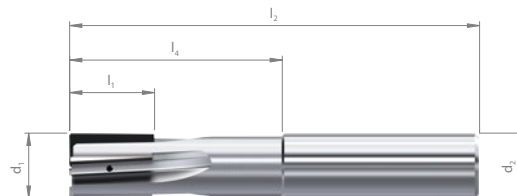

ORDER-CODE → PKD-SF →									
d ₁ Nenn-Ø nom. Ø	z Zähne- zahl No. of teeth	l ₄ Nutz- länge use length	d ₂	l ₂	l ₁	Stirnausführung face design		Schneideckenausführung cutting corner design	
10	3	34	10	74	5		-		
					10				
					15				
					20				
12	3	38	12	83	5		-		
					10				
					15				
					20				
14	4	52	14	100	5		-		
					10				
					15				
					20				
16	4	52	16	100	5		-		
					10				
					15				
					20				
20	5	53	20	103	5		-		
					10				
					15				
					20				

Weitere Abmessungen, Abmaße und Spezifikationen auf Anfrage

Further measurements, dimensions and specifications on request

M
MF
MJ
EG M

G
Rc, R
Pg

UNC
UNF
UN
UNJF

NPT
NPTF

M
MF
M keg.
M taper

G
BSW
BSF
DIN 477
R, BA, Pg

UNC
UNF
UNEF
UN, UNS

NPSM
NPT
NPTF
Tr, Rd

M
MF

G
BSW
BSF
R, Pg
MF-EL

UNC, UNF
UNEF
UN, UNS
UNJC
UNJF

NPT
NPTF
Tr
EG



Anwendungsempfehlungen und Schnittdaten

Reference of application and cutting data

Material	material						PKD/PCD					
		Festigkeit tensile [N/mm ²]	Härte hardness [HB]	Härte hardness [HRC]	Werkstoffbeispiel workpiece example	Werkstoffnr. workpiece material no.	v _c [m/min]	f _z [mm]				
							d ≤ 6 mm	d ≤ 8 mm	d ≤ 10 mm	d ≤ 12 mm	d > 12 mm	
Stahlwerkstoffe/Steel	gehärtete Stähle 52 - 56 HRC hardened steels 52 - 56 HRC	≤ 1950		≤ 56	X210Cr12 X38CrMoV5-1	1.2080 1.2343						
	gehärtete Stähle 56 - 60 HRC hardened steels 56 - 60 HRC	≤ 2150		≤ 60	90MnCrV8 100Cr6	1.2842 1.3505						
	gehärtete Stähle > 60 HRC hardened steels > 60 HRC	> 2150		> 60	X165CrV12 200CrMn8	1.2201 1.2129						
	HSS high speed steel				HS6-5-3 HS6-5-2-5	1.3344 1.3243						
Guss/Cast iron	Gusseisen mit Lamellengraphit grey cast iron	≤ 320	≤ 300		GG20 GG35	0.6020 0.6035						
	Gusseisen mit Kugelgraphit nodular cast iron	≤ 800			GGG-40 GGG-80	0.7040 0.7080						
	Temperguss malleable cast iron	≤ 420	≤ 230		GTW-35-04 GTW-S38-12	0.8035 0.8038						
Titan/Titanium	Reintitan pure titanium	≤ 450			Ti Ti	3.7025 3.7035	60 - 180	0,005 - 0,040	0,020 - 0,060	0,040 - 0,080	0,040 - 0,100	0,050 - 0,150
	Titanlegierungen titanium alloys	≤ 900			Ti-6Al-4V Ti-3Al	3.7164 3.7065	60 - 180	0,005 - 0,040	0,020 - 0,060	0,040 - 0,080	0,040 - 0,100	0,050 - 0,150
	Titanlegierungen titanium alloys	≤ 1200			TiAl4Mo4Sn2Si0.5		60 - 180	0,002 - 0,030	0,015 - 0,050	0,030 - 0,060	0,030 - 0,080	0,040 - 0,120
Magnesium	Magnesium-Knetlegierungen wrought magnesium alloys	≤ 310			MgMn2 MgAl8Zn	3.5200 3.5812	300 - 5000	0,005 - 0,130	0,080 - 0,200	0,130 - 0,250	0,130 - 0,330	0,160 - 0,500
	Magnesium-Gusslegierungen cast magnesium alloys	≤ 170			G-MgAl8Zn1 G-MgAl6	3.5912 3.5662	300 - 5000	0,005 - 0,130	0,080 - 0,200	0,130 - 0,250	0,130 - 0,330	0,160 - 0,500
Aluminium	Aluminium unlegiert aluminium	≤ 140	≤ 50		Al99 Al99,8	3.0205 3.0285	200 - 6000	0,005 - 0,080	0,050 - 0,120	0,080 - 0,150	0,080 - 0,200	0,100 - 0,300
	Aluminium-Knetlegierungen wrought aluminium alloys	≤ 520	≤ 140		AlCuMg2 AlZnMgCu1,5	3.1355 3.4365	200 - 6000	0,005 - 0,080	0,050 - 0,120	0,080 - 0,150	0,080 - 0,200	0,100 - 0,300
	Alu-Gusslegierungen < 12% Si aluminium alloy castings < 12% Si	≤ 210	≤ 110		G-AlSi10Mg G-AlMg5Si	3.2381 3.3261	200 - 4000	0,005 - 0,070	0,040 - 0,100	0,070 - 0,120	0,070 - 0,170	0,080 - 0,250
	Alu-Gusslegierungen > 12% Si aluminium alloy castings > 12% Si	≤ 300	≤ 90		G-AlSi12	3.2581	200 - 2000	0,005 - 0,050	0,030 - 0,080	0,050 - 0,100	0,050 - 0,130	0,070 - 0,200
Kupfer/Copper	Kupfer-Zink-Legierungen copper-zinc alloys (brass)	≤ 470			CuZn40 CuZn38Pb1,5	2.0360 2.0371	250 - 1400	0,005 - 0,080	0,050 - 0,120	0,080 - 0,150	0,080 - 0,200	0,100 - 0,300
	bleifreie Kupfer-Zink-Legierungen lead free copper zinc alloys (ECOBRESS)				CW724R C69300		200 - 1100	0,005 - 0,060	0,040 - 0,100	0,060 - 0,120	0,060 - 0,160	0,080 - 0,240
	Kupfer-Zinn-Legierungen copper-tin alloys (bronze)	≤ 700			CuSn6 CuSn8	2.1020 2.1030	250 - 1400	0,005 - 0,080	0,050 - 0,120	0,080 - 0,150	0,080 - 0,200	0,100 - 0,300
	Kupfer-Aluminium-Legierungen copper-aluminium alloys	≤ 600			CuAl8 CuAl9Mn2	2.0920 2.0960	250 - 1400	0,005 - 0,080	0,050 - 0,120	0,080 - 0,150	0,080 - 0,200	0,100 - 0,300
Kunststoffe/Plastics	Thermoplaste thermoplastics						100 - 2500	0,005 - 0,080	0,050 - 0,120	0,080 - 0,150	0,080 - 0,200	0,100 - 0,300
	Duroplaste thermosets						100 - 2500	0,005 - 0,080	0,050 - 0,120	0,080 - 0,150	0,080 - 0,200	0,100 - 0,300
	faserverstärkte Kunststoffe fiber reinforced plastics						200 - 3000	0,005 - 0,100	0,070 - 0,160	0,100 - 0,200	0,100 - 0,250	0,120 - 0,400
	Graphit graphite						150 - 2500	0,005 - 0,100	0,070 - 0,160	0,100 - 0,200	0,100 - 0,250	0,120 - 0,400
	Metallmatrix-Verbundwerkstoffe, MMC metal matrix composite, MMC						150 - 800	0,005 - 0,100	0,070 - 0,160	0,100 - 0,200	0,100 - 0,250	0,120 - 0,400
	PMMA, Acryl PMMA, acrylic						100 - 1200	0,005 - 0,070	0,040 - 0,100	0,070 - 0,120	0,070 - 0,170	0,080 - 0,250

Die angegebenen Werte sind Erfahrungswerte, die bei optimalen Bedingungen realisierbar sind. Diese Werte sind abhängig von Gewindeart, Gewindetiefe, Maschine (Steifigkeit, Aufspannung etc.) und Ausführung des Werkzeuges. Je nach Bedarf müssen diese Werte den Gegebenheiten angepasst werden.



M
MF
MJ
EG M

G
Rc, R
Pg

UNC
UNF
UN
UNJF

NPT
NPTF



M
MF
M keg.
M taper

G
BSW
BSF
DIN 477
R, BA, Pg

UNC
UNF
UNEF
UN, UNS

NPSM
NPT
NPTF
Tr, Rd



M
MF

G
BSW
BSF
R, Pg
MF-EL

UNC, UNF
UNEF
UN, UNS
UNJC
UNJF

NPT
NPTF
Tr
EG

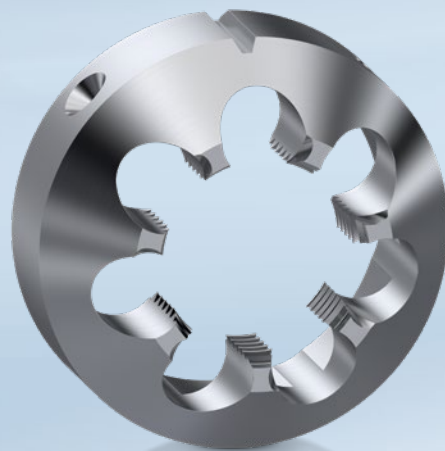
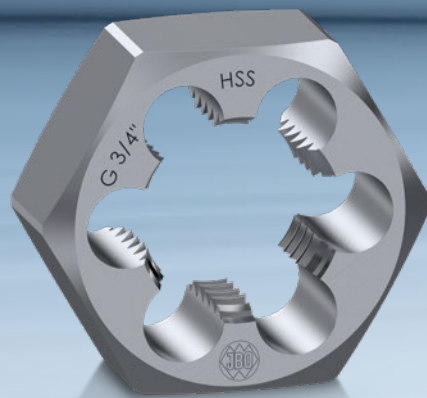



Hochleistungs-Schneideisen

High Performance Thread Cutting Dies

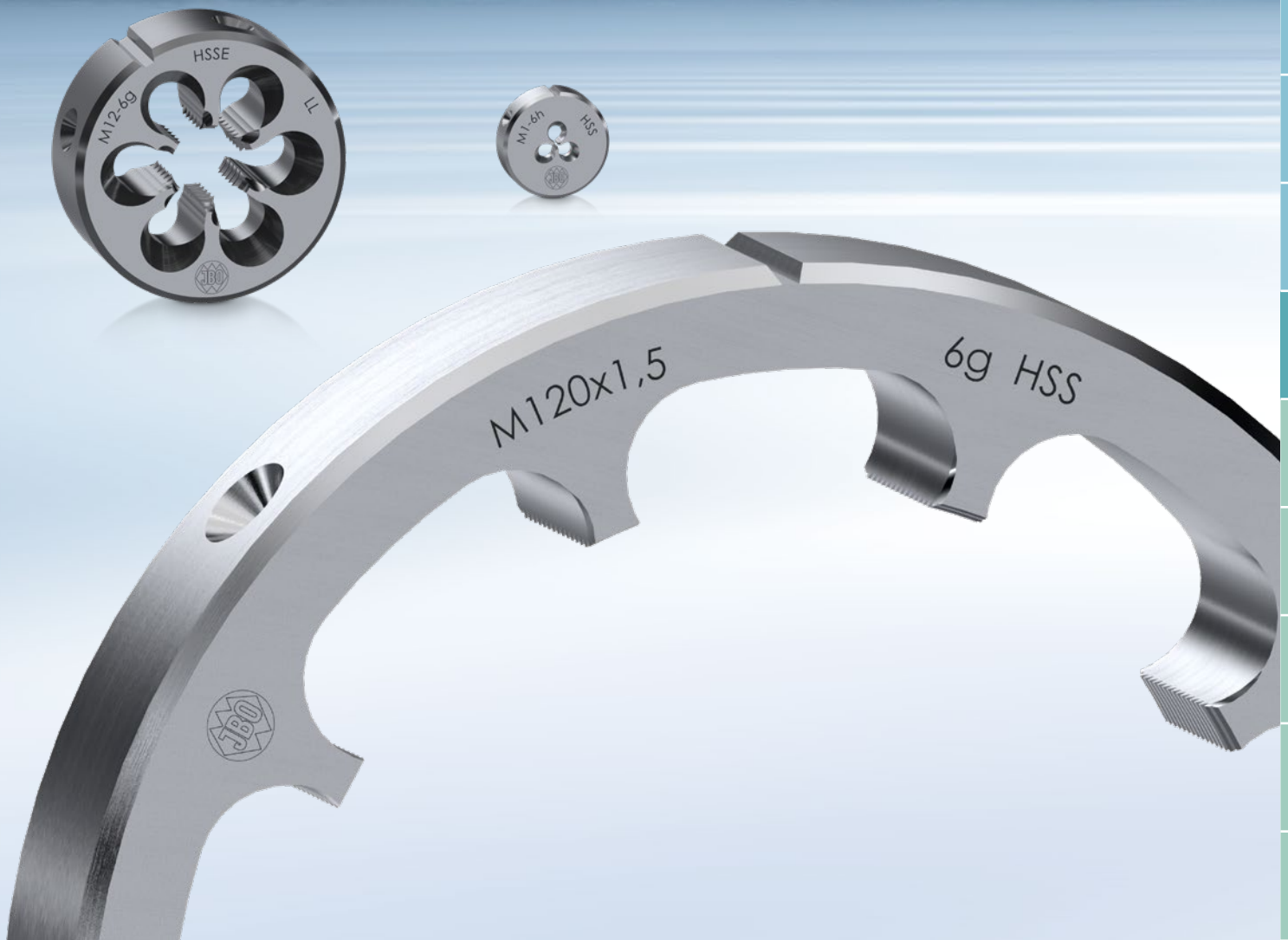

M
MF
MJ
EG M

G
Rc, R
Pg

UNC
UNF
UN
UNJF

NPT
NPTF



M
MF
M keg.
M taper

G
BSW
BSF
DIN 477
R, BA, Pg

UNC
UNF
UNEF
UN, UNS

NPSM
NPT
NPTF
Tr, Rd



M
MF

G
BSW
BSF
R, Pg
MF-EL

UNC, UNF
UNEF
UN, UNS
UNJC
UNJF

NPT
NPTF
Tr
EG



M
MF
MJ
EG M

G
Rc, R
Pg

UNC
UNF
UN
UNJF

NPT
NPTF



M
MF
M keg.
M taper

G
BSW
BSF
DIN 477
R, BA, Pg

UNC
UNF
UNEF
UN, UNS

NPSM
NPT
NPTF
Tr, Rd



M
MF

G
BSW
BSF
R, Pg
MF-EL

UNC, UNF
UNEF
UN, UNS
UNJC
UNJF

NPT
NPTF
Tr
EG

Hochleistungs-Schneideisen

High Performance Thread Cutting Dies

Allgemeine Information General Information

Allgemeine Vorteile der JBO Präzisions-Schneideisen <small>General advantages of JBO Precision Thread Cutting Dies</small>	Seite/page 148
Übersicht Hochleistungs-Schneideisen <small>Overview High Performance Thread Cutting Dies</small>	Seite/page 149
Hightech Schneideisen aus Hartmetall <small>High-tech Carbide Thread Cutting Dies</small>	Seite/page 150
Schneideisen-Beschichtungen <small>Coating for Thread Cutting Dies</small>	Seite/page 151
Kunden-individuelle Sonder-Gewindeschneideisen <small>Special Client-Specific Thread Cutting Dies</small>	Seite/page 152
Technische Angaben <small>Technical Information</small>	Seite/page 154
Anwendungsempfehlungen und Schnittdaten <small>Reference of application and cutting data</small>	Seite/page 156
Außendurchmesser-Toleranzen für Bolzengewinde <small>Bolt diameter tolerances for external threads</small>	Seite/page 158

M Metrisches ISO-Gewinde <small>ISO metric thread</small>	Seite/page 162
MF Metrisches ISO-Feingewinde <small>ISO metric fine thread</small>	Seite/page 171
M keg. M taper Metrisches kegeliges Außengewinde <small>Metric external taper thread</small>	Seite/page 180

G Whitworth-Rohrgewinde <small>Whitworth pipe thread</small>	Seite/page 181
BSW Whitworth-Gewinde <small>British Standard Whitworth thread</small>	Seite/page 185
BSF Whitworth-Feingewinde <small>British Standard Whitworth fine thread</small>	Seite/page 187
DIN 477 Gewinde an Gasflaschenventilen <small>Threads on gas cylinder valves</small>	Seite/page 188
R Kegeliges Whitworth-Rohrgewinde <small>Tapered Whitworth pipe thread</small>	Seite/page 189
B.A. B.A.-Gewinde <small>British Association Standard thread</small>	Seite/page 190
Pg Stahlpanzerrohr-Gewinde <small>Steel conduit thread</small>	Seite/page 191

UNC UNC-Grobgewinde <small>Unified national coarse thread</small>	Seite/page 192
UNF UNF-Feingewinde <small>Unified national fine thread</small>	Seite/page 194
UNEF UNEF-Extra Feingewinde <small>Unified national extra fine thread</small>	Seite/page 196
UN/UNS UN-Gewinde, UNS-Spezialgewinde <small>Unified national thread, Unified national special thread</small>	Seite/page 197

NPSM NPSM-Amerikanisches Rohrgewinde <small>National straight pipe thread for mechanical joints</small>	Seite/page 198
NPT NPT-Kegeliges Amerikanisches Rohrgewinde <small>American Standard taper pipe thread</small>	Seite/page 199
NPTF NPTF-Kegeliges Amerikanisches Rohrgewinde <small>American Standard taper pipe thread</small>	Seite/page 201
Tr Metrisches ISO-Trapez-Gewinde <small>ISO metric trapezoidal thread</small>	Seite/page 202
Rd Rundgewinde <small>Knuckle thread</small>	Seite/page 203

Schneideisenhalter <small>Precision Die Stocks</small>	Seite/page 204
--	----------------



Allgemeine Vorteile der JBO Präzisions-Schneideisen

General advantages of JBO Precision Thread Cutting Dies

- JBO ist Europas führender Gewindeschneideisen-Hersteller
 - Unübertroffenes Gewindeflanken- und Schneidkanten-Finish
 - Lager mit über 10.000 verschiedenen Abmessungen und Ausführungen von Gewinde-Ø 1–200 mm für alle Gewindearten
 - Wir liefern Schneideisen abgestimmt auf den zu schneidenden Werkstoff und Anwendungsfall in HSS, HSSE oder Hartmetall. Ist eine Oberflächenbehandlung notwendig oder von Vorteil, bieten wir dies ebenfalls an.
 - Weitreichende Erfahrungen im Sondergewinde-Bereich
- JBO is the leading European manufacturer of thread cutting dies
 - Unsurpassed surface finish of thread flanks and cutting edges
 - More than 10,000 sizes and types of dies kept in stock for all kinds of threads ranging from 1 to 200 mm diameter
 - We can supply HSS, HSSE or carbide thread cutting dies, matched to the particular workpiece material and application in each case. If a surface treatment is necessary or advantageous, we also offer this.
 - Far-reaching experience in the range of special threads

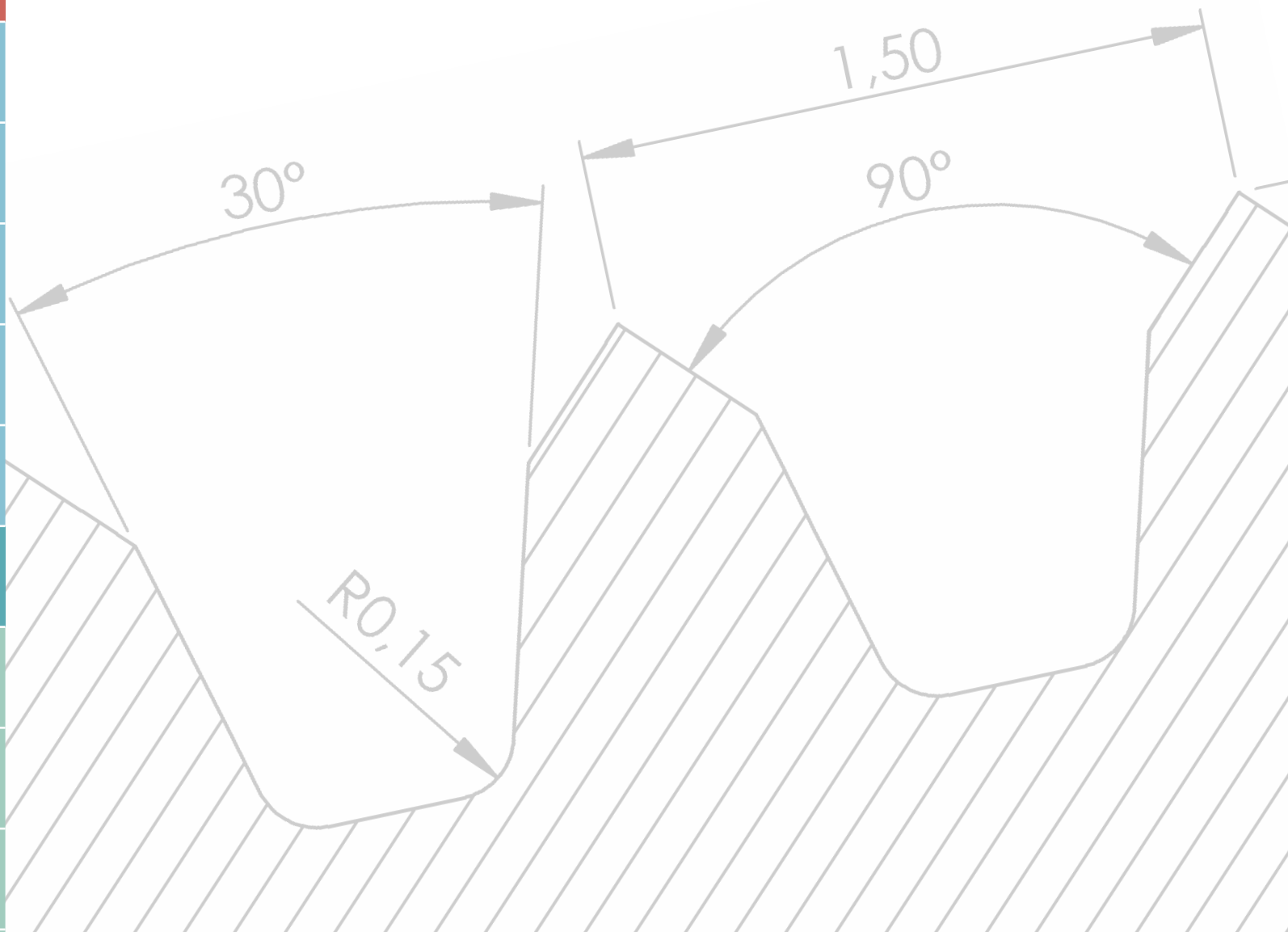

JBO bietet Ihnen ein grenzenloses Schneideisen-Spektrum in höchster Präzision!
There are no limits to the range of JBO High Precision Thread Cutting Dies!



Hochleistungs-Schneideisen

High Performance Thread Cutting Dies

RU



Schneideisen aus HSS nach DIN EN Norm

- für Hand- oder Maschinengebrauch
- zum Schneiden von Stahl bis ca. 800 N/mm²
- zum Schneiden unterschiedlichster Werkstoffe

HSS thread cutting dies to DIN EN standards

- for machine and manual use
- for cutting threads in steel up to approx. 800 N/mm² tensile strength
- different versions for cutting a wide range of materials

VA



VA-Schneideisen

- Zur Bearbeitung von rost- und säurebeständigen Stählen, Vergütungsstählen, Einsatzstählen usw. bis 1.200 N/mm² und Alu-Legierung kurzspanen
- HSSE, geläppt
 - gegen Kaltschweißungen nitriert
 - feine Spanaufteilung durch höhere Schneidstollenzahl und längeren Anschnitt 2 P

VA thread cutting dies

- For machining stainless and acid-resistant steels, quenched and tempered steels, case-hardened steels, etc. up to 1,200 N/mm² and short-chipping aluminum alloys.
- HSSE, lapped
 - nitrided to prevent cold welding
 - fine chips due to more clearance holes and thus more cutting edges, and the extension of the chamfer to 2 P

GL



Glockenform-Schneideisen

Freies Abfließen der Späne und verbesserte Kühl-Schmiermittelzufuhr durch offene Spanräume, auch wenn nahe am Bund geschnitten wird.

Bell form type thread cutting dies

With open clearance holes for free chip flow and improved coolant supply, even when cutting threads close to shoulders.

JBO ist Europas führender Gewindeschneideisen-Hersteller.

Mit JBO-Schneideisen arbeiten Sie präzise und wirtschaftlich!

JBO is the leading European manufacturer of thread cutting dies.

JBO dies do not only cut high precision threads, but are also very cost-effective!



Autom



Automaten-Schneideisen

Mit größerer Schneidstollenzahl und erweiterten Spanlöchern garantieren höhere Standzeit und höhere Qualität.

Thread cutting dies for automatics

With greater number of enlarged clearance holes, hence more cutting edges for longer die life and higher quality threads.

LL



Long Life-Hochleistungsschneideisen

Anwendungsgebiet wie bei VA-Schneideisen

- HSSE (ASP 30), geläppt
- gegen Kaltschweißungen nitriert
- feinste Spanaufteilung durch höchste Schneidstollenzahl und längeren Anschnitt 2,25 P
- Long Life steht für enorme Standzeit

Long Life-High performance thread cutting dies

- Field of application as for VA thread cutting dies
- HSSE (ASP 30) lapped
 - nitrided to prevent cold welding
 - very fine chips due to maximum number of clearance holes and thus still more cutting edges, and the extension of the chamfer to 2.25 P
 - exceptionally long die life

SK



Sechskant-Schneideisen

Zum Nachschneiden und Reparieren von beschädigten Gewinden oder zum Schneiden an schwer zugänglichen Stellen.

Hexagon die nuts

For recutting and reclaiming damaged threads or for cutting threads in hard to reach places.

MS

Ecobrass



Schneideisen für die Messingbearbeitung

Kein Zusetzen der Spanlöcher mit Spänen durch erweiterte Spanlöcher, Anschnitt 1,25 P, mit Schälanschnitt \geq Gewinde \varnothing 3 mm.

Schneideisen für ECOBRASS

Zur Bearbeitung von bleifreiem Messing

- HSSE, geläppt, Anschnitt 1,5 P

Thread cutting dies for brass

Enlarged clearance holes prevent chips crowding, chamfer 1.25 P, with spiral entry (gun nose) for threads \geq 3 mm diameter.

Thread cutting dies for ECOBRASS

For machining unleaded brass

- HSSE, lapped, chamfer 1.5 P

ASL



Schneideisen mit Aufschraublöchern

Durch die geringere Massenträgheit des Schneideisenhalters sind höhere Drehzahlen/Standzeiten möglich.

Dies with mounting holes

The low inertia of the die holder permits higher spindle speeds and extends die life.

GL HM



Hightech Schneideisen aus Hartmetall alternativ mit eingelöteten Schneidstegen

Zur Bearbeitung von Messing und Rotguss, Gewinde- \varnothing $>$ ca. 16 mm

- hohe Schnittgeschwindigkeit bis 100 m/min
- 15 bis 30fache Standzeit
- reduzierte Werkzeugwechselkosten
- geringere Maschinenstillstandkosten
- Vorteile durch Trockenbearbeitung

High-tech carbide thread cutting dies alternative carbide-tipped (brazed)

For machining brass and gun metal, available for thread diameters $>$ approx. 16 mm

- high cutting speeds up to 100 m/min
- 15 to 30 times longer die life
- reduced die changing costs
- less machine down time
- advantages arising from dry machining



Hightech Schneideisen aus Hartmetall alternativ mit eingelöteten Schneidstegen

High-tech Carbide Thread Cutting Dies alternative Carbide-Tipped (brazed)

Diese Schneideisen sind erprobt für Schnittgeschwindigkeiten bis 100 m/min. Bei entsprechender Maschinenleistung machen wir gerne Versuche mit noch höheren Geschwindigkeiten. Die enormen Werkzeugstandzeiten und Geschwindigkeiten wurden bei Trockenbearbeitung erzielt. (Recycling-Vorteile!) Anwendung finden diese Schneideisen überwiegend für Messing, Rotguss und Bronze.

JBO-Schneideisen aus Hartmetall werden mit Gewindehinterschliff versehen. Dadurch wird das Schneidmoment reduziert und die Neigung zu Kaltschweißungen ist gering. Die Standzeiten sind 15 bis 30 mal höher als mit HSS-Schneideisen. Die Wirtschaftlichkeit ist daher hervorragend. Wir fertigen HM-Schneideisen in VHM-Ausführung oder mit eingelöteten HM-Schneidstegen ab Gewinde-Ø > ca. 16 mm und für Steigungen von 1 bis 2,5 mm bzw. 11 bis 24 Gang/Zoll in DIN EN Ausführung, Glockenform und Sonderbaumaße nach Kundenwunsch. Schneideisen aus Hartmetall für G-Gewinde siehe Seite 181 und für R-Gewinde siehe Seite 189.

These cutting dies have been tried and tested for cutting speeds up to 100 m/min. We will gladly carry out trials with still higher cutting speeds where machines have the requisite capability. The far greater tool lives and cutting speeds were achieved with dry machining, thereby facilitating the recycling of the chips produced. These dies are mostly used for working brass, gun metal and bronze.

JBO solid carbide dies are equipped with a thread relief grinding. Thereby the cutting torque is reduced and the tendency to cold weld is eliminated. The durability is 15 to 30 times higher than with a HSS-cutting die. They are therefore outstandingly cost effective. We manufacture carbide thread cutting dies in solid carbide version or alternative carbide-tipped (brazed) for threads from approx. 16 mm dia. upwards and for pitches from 1 to 2.5 mm or 11 to 24 tpi to DIN EN specifications. Bell form type dies and special size dies to suit customer requirements can also be supplied. Carbide cutting dies for G-threads see page 181 and for R-threads see page 189.

- | | |
|---|--|
| <ul style="list-style-type: none"> • Höhere Schnittgeschwindigkeit • Vielfache Standzeit • Reduzierte Werkzeugwechselkosten • Geringe Maschinenstillstandskosten • Vorteile durch Trockenbearbeitung | <ul style="list-style-type: none"> • Higher cutting speed • Multiple tool life • Reduced tool changing costs • Less machine down time • Advantages by dry machining |
|---|--|

JBO Hartmetall-Schneideisen reduzieren die Fertigungskosten erheblich

Beispiele aus der Armaturenindustrie

Bearbeitung von Rotguss mit einem JBO-HM-Schneideisen:
G 3/4": 260.000 Teile (ein Werkzeug dreimal nachgeschliffen).
M 22 x 1: 780.000 Teile (ein Werkzeug fünfmal nachgeschliffen).

JBO solid carbide dies cut the production costs appreciably

Examples from the valve industry

Machining of gunmetal with a JBO solid carbide cutting tool:
G 3/4": 260 000 parts (one tool reground three times).
M 22 x 1: 780 000 parts (one tool reground five times).

Vollhartmetall-Schneideisen
Solid carbide thread cutting die

Schneideisen mit eingelöteten
HM-Schneidstegen
Thread cutting die
with brazed carbide
cutting edges

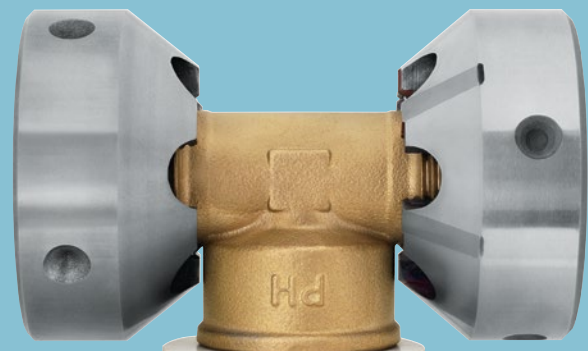

Beschichtete HSS- und HSSE-Schneideisen für höhere Leistung und Oberflächengüte

Coated HSS and HSSE Thread Cutting Dies for greater performance and surface finish

Wir empfehlen und liefern Ihnen beschichtete Schneideisen für die Bearbeitung von
We recommend and supply coated dies

Stahl steel	mit JBOcoat-Beschichtung with JBOcoat coating	→	sehr gut geeignet highly suitable
	mit TiCN-Beschichtung with TiCN coating	→	gut geeignet well suitable
	mit TiN-Beschichtung with TiN coating	→	gut geeignet well suitable
<p>Am Lager vorrätige VA (HSSE) und LL (Long Life) Schneideisen in nitrierter Ausführung können nur JBOcoat beschichtet werden, nicht jedoch TiCN oder TiN! Nitrided VA (HSSE) and LL (Long Life) dies in stock can only be coated with JBOcoat but not TiCN or TiN!</p>			
Buntmetall und Ecobrass non-ferrous metall and Ecobrass	mit DLC-Beschichtung with DLC coating	→	sehr gut geeignet highly suitable
Messing brass	mit CrN-Beschichtung with CrN coating	→	gut geeignet well suitable

Lieferzeit: Wenn die Schneideisen vorrätig sind, benötigen wir für eine zusätzliche Beschichtung ca. 1 bis 2 Wochen.
Delivery period: If the dies are in stock, we need about 1 to 2 weeks for additional coating.

Zuschläge für das Beschichten von Schneideisen in EURO netto:
Surcharges for coating thread cutting dies, net price in EURO:

Ø D	TiCN, TiN, CrN	JBOcoat	DLC
16	3,90	6,20	9,30
20	4,40	6,90	10,60
25	5,20	8,30	12,80
30	6,60	10,50	16,40
38	8,60	13,70	21,70
45	12,30	19,60	31,20
55	17,60	28,10	45,40
65	22,30	35,60	58,20
75	32,10	51,30	84,80
90	38,80	62,10	104,40

Die Eignung der Beschichtung hängt bei allen Zerspanungsprozessen von vielen Faktoren ab. Lassen Sie sich bei der Optimierung der Schneidergebnisse von unserer Anwendungstechnik beraten.
The suitability of the coating depends on many factors in all cutting processes. Let our technical application department advise you to optimize your cutting results.



Kunden-individuelle Sonder-Gewindeschneideisen

Special Client-Specific Thread Cutting Dies

Kurze Wege, jahrzehntelanges Know-how: Kunden-spezifische Sonderwerkzeuge werden bei JBO effizient und schnell entwickelt und realisiert.

Short distances and decades of experience: Special client-specific tools are developed and realized efficiently and quickly at JBO.

- 1 Sonder-Vorbau-Schneideisen mit zwei Absätzen zum Gewindeschneiden bei eingeschränkten Raumverhältnissen. Mit kundenspezifischer Aufnahme für automatischen Werkzeugwechsel auf Bearbeitungszentren ausgelegt.

Special die with projecting nose for thread cutting in restricted space conditions. Designed with customer-specific mounting for automatic tool change on machining centres.

- 2 Sonder-Vorbau-Schneideisen mit kegeligem Vorbau für den Einsatz bei stark eingeschränkten Raumverhältnissen. Späneabfuhr über die seitlich angeordneten Langlöcher am zylindrischen Absatz.

Special die with tapered projecting nose for use in highly restricted space conditions. Chip removal via the laterally arranged oblong holes on the cylindrical shoulder.

- 3 Sonderschneideisen für schwer zugängliche Gewinde, sowie zum Nachschneiden von ortsfesten Gewinden.

Special cutting dies for difficult to access threads, as well as recutting stationary threads.

- 4 Gewindeschneideisen, geschlitzt, mit radialer Stellschraube.

A split thread cutting die with a radial adjusting screw.

- 5 Sonderschneideisen für kundenspezifisches Holzschraubengewinde mit modifiziertem Gewindeprofil.

Special cutting die for client-specific wood-screw threads with modified thread profile.

- 6 Sonderschneideisen mit beidseitigem glockenartigem Vorbau. Die Fertigung beider Gewinde erfolgt gleichzeitig. Werkzeugaufnahme mittig.

Special die with bell-shaped form on both sides. Cuts two threads simultaneously. Mid-mounted.



1

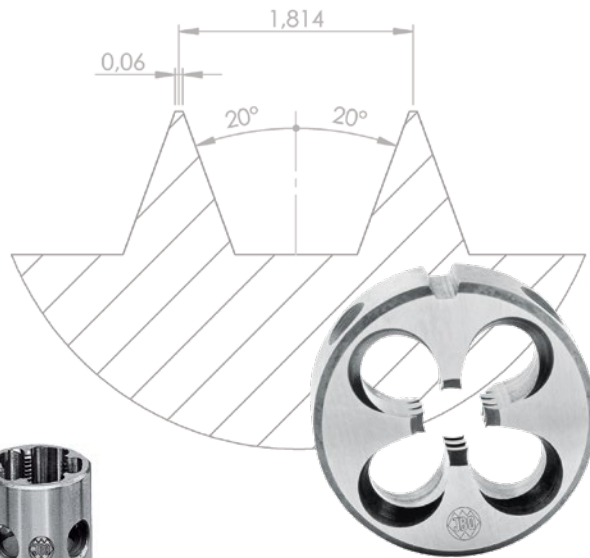

5



3



2



4



6

7 Mehrgängiges Schneideisen für kundenspezifisches Trapezgewinde, Tr 22 x 6 P1,5 (4-gängig).

Multiple start cutting die for client-specific trapezoidal thread, Tr 22 x 6 P1.5 (4 starts).

8 Sonderschneideisen für Gewinde, die in Ausdrehungen oder Vertiefungen angeordnet sind.

Special dies arranged for threads inside bores or recesses.

9 Gewindeschneideisen, geschlitzt, mit tangentialer Stellschraube.

A split thread cutting die with a tangential adjusting screw.

10 Elastikschnideisen unbeschichtet und mit TiN-Beschichtung. Zur Aufnahme wird ein Spezial-Elastikschnideisen-Halter verwendet. Das Schneideisen ist verstellbar und schneidet mit wesentlich geringerem Drehmoment (verstellbar z.B. von 4h bis 6g).

Elastic thread cutting die, uncoated or with TiN coating. For mounting in a dedicated die holder. The die is adjustable and cuts with appreciably less torque (adjustable e.g. from 4h to 6g).

11 Sonderschneideisen in Kombination mit Sonderschneideisenhalter inkl. Rändelfunktion, vereint zwei Arbeitsgänge in einem Bearbeitungsschritt.

Special thread cutting die in combination with special die holder including knurling function, combines two operations in one machining step.

12 Schneideisen mit Innenkühlung und DLC-Beschichtung.

Thread cutting die with internal coolant and DLC coating.

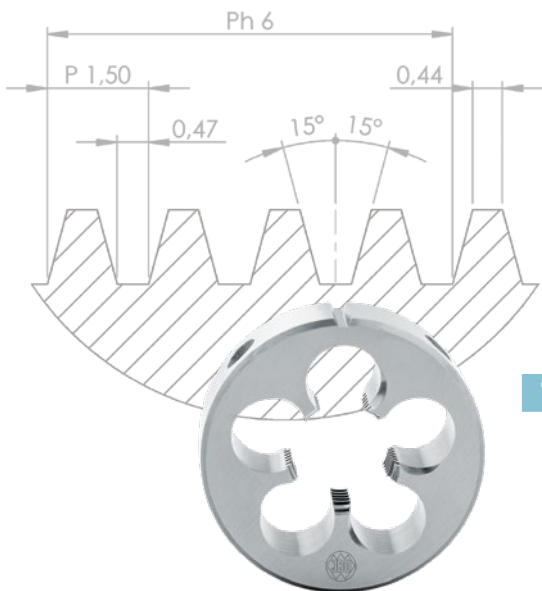

7



11



10



8



9



12

M MF MJ EG M	
G Rc, R Pg	
UNC UNF UN UNJF	
NPT NPTF	
M MF M keg. M taper	
G BSW BSF DIN 477 R, BA, Pg	
UNC UNF UNEF UN, UNS	
NPSM NPT NPTF Tr, Rd	
M MF	
G BSW BSF R, Pg MF-EL	
UNC, UNF UNEF UN, UNS UNJC UNJF	
NPT NPTF Tr EG	

Technische Angaben

Begriffe und Maßerklärungen

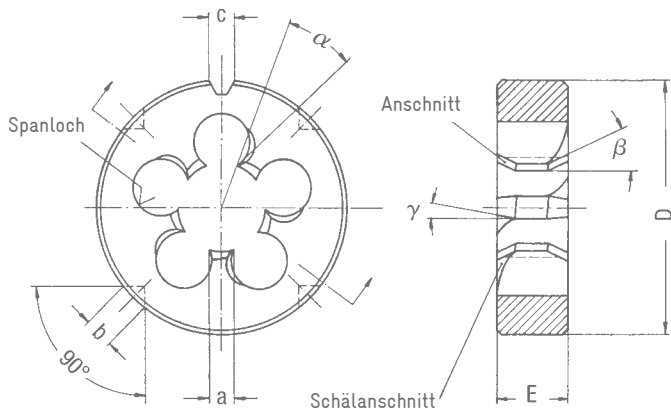

D = Außendurchmesser
(Toleranzfeld f8)
E = Breite
a = Zahnbreite
c = Nutbreite
b = Durchmesser der Bohrung
für Halteschraube

α = Spanwinkel
 β = Ansnittwinkel,
halber Senkwinkel
 γ = Schälanschnittwinkel

Ausführung

Form A geschlitzt

Form B geschlossen

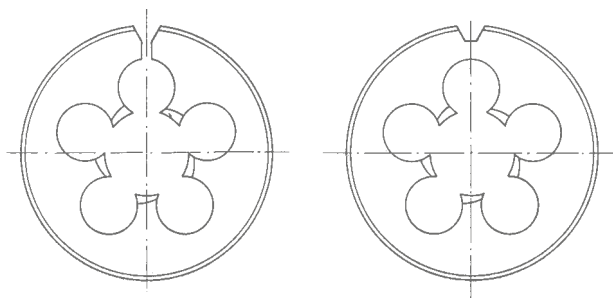

Unsere Schneideisen liefern wir, wenn in der Bestellung keine Angaben enthalten sind, in Form B

Schneideisen-Toleranzklassen

Wenn in der Bestellung keine Toleranzangaben gemacht werden, liefern wir Schneideisen für Metr. ISO-Gewinde Toleranz 6g (\pm M 1,4 Tol. 6h), für Whitworth-Rohrgewinde Toleranzklasse A und für Unified National-Gewinde Toleranzklasse 2A. Außerdem fertigen wir Metr. ISO-Gewinde für die Toleranz 4h, 6h und 6e, Whitworth-Rohrgewinde für verschiedene Minusmaße und Unified National-Gewinde für die Toleranz 3A. Diese Toleranzfelder müssen jedoch in der Bestellung angegeben werden.

Verwendung:

4h für Toleranzklasse „fein“
(Bolzen bleibt blank oder wird dünn phosphatiert);

6g über Gewinde- \varnothing 1,4
6h bis Gewinde- \varnothing 1,4
für Toleranzklasse „mittel“
(Bolzen bleibt blank, wird phosphatiert oder nur mit einer dünnen galvanischen Schutzschicht versehen);

6e für Toleranzklasse „mittel“
(Bolzen wird mit einer dicken galvanischen Schutzschicht versehen).
Schneideisen 6e schneiden ca. 0,03 mm kleiner als 6g.

Weitere Gewinde-Toleranzen auf Anfrage.

Werkstückvorbereitung

Das zu schneidende Werkstück wird mit einer zentrischen Fase versehen. Dies bewirkt ein leichtes Anschneiden und führt zu zentrischen Gewinden. Der Bolzendurchmesser muss ein Untermaß gegenüber dem Nenndurchmesser des zu schneidenden Gewindes haben (siehe Richtwert-Tabellen Seite 158 bis 161), Kaltschweißungen im Schneideisen-Gewinde-Außendurchmesser und ein Ausreißen der Gewindegänge können dadurch vermieden werden. Wird der Gewindeauslauf am Bolzen mit einem Einstich versehen, verhindert dies ein Ausbrechen der Schneideisen beim Rücklauf.

Anschnitt

Standard-Anschnitt:

Die Ansnittlänge ist in den Preistabellen angegeben.

70° (kurzer Ansnitt):

Sollen Gewinde dicht an einen Bund geschnitten werden, liefern wir Schneideisen mit reduzierter Ansnittlänge. Die reduzierte Ansnittlänge beträgt ca. 1,25 Steigungen, dies entspricht einem Senkwinkel von 70°. Ein kurzer Ansnitt kann vom Kunden nicht durch Planschleifen erzielt werden, da der notwendige Ansnitt- \varnothing dann zu klein ist und das Schneideisen nicht mehr richtig schneidet.

Kürzere Ansnittlänge auf Anfrage.

Technical Information

Die nomenclature

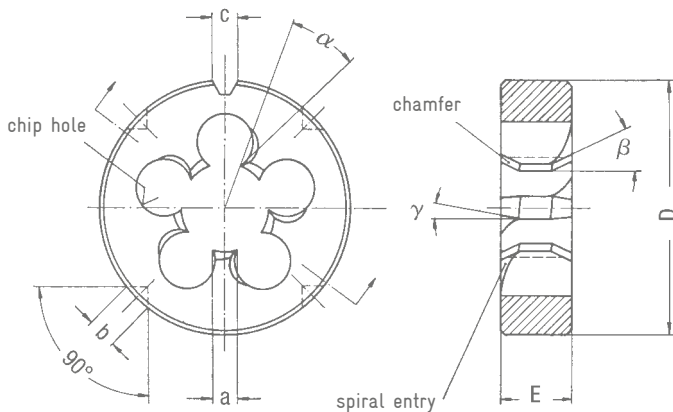

D = outside diameter
(tolerance zone f8)
E = thickness
a = width of tooth
c = width of notch
b = diameter of hole for
fixing screw

α = rake angle
 β = chamfer angle
 γ = spiral angle

Specification

Form A split

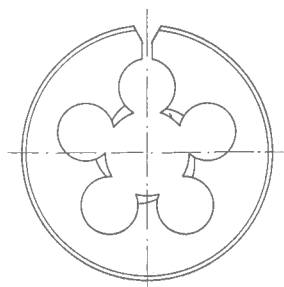

Form B solid

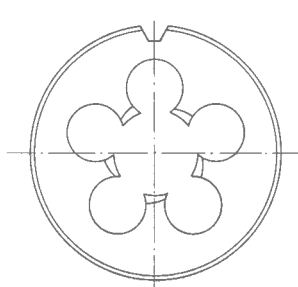

We supply our thread cutting dies in form B unless otherwise specified on the order

Cutting dies tolerance classes

If no tolerances are specified in the order, we supply dies for ISO metric threads to satisfy class 6g tolerances ($\leq M 1.4$ tol. 6h), dies for Whitworth pipe thread to satisfy class A tolerances and for dies for Unified National Thread to satisfy class 2A tolerances. We also manufacture dies for ISO metric thread to satisfy 4h, 6h and 6e tolerances, dies for various undersizes (Whitworth pipe thread) and dies for Unified National Thread to satisfy class 3A tolerances. These tolerance zones, however, must be specified in the purchase order.

The following applies:
4h for "fine" class tolerances (bolt remains uncoated or is thinly phosphated);

6g for threads over 1.4 mm dia.
6h for threads up to 1.4 mm dia. for "medium" class tolerances (bolt remains uncoated is phosphated or only provided with a thin electroplated protective layer)

6e for "medium" class tolerances (thread is heavily electroplated).
6e dies cut threads approx. 0.03 mm smaller than 6g dies.

Other thread tolerances on request.

Preparation of workpiece

The workpiece to be cut is provided with a centric chamfer. This makes it easy to cut and produces centric threads. The bolt diameter must be smaller than the nominal diameter of the thread to be cut (see guide lines in tables on pages 158 to 161). Cold welding in the die thread outer diameter and tearing of the threads can thus be avoided. If the thread run-out on the bolt is provided with a recess, this prevents the die from chipping on return.

Chamfer

Standard chamfer:
The length of chamfer is indicated in the price tables.

70° (short chamfer):
Where threads have to be cut close to a shoulder, we supply dies with a reduced chamfer length. The reduced chamfer length is approx. 1.25 pitches, which corresponds to a countersink angle of 70°. Customers cannot shorten the chamfer by surface grinding, as this results in a chamfer diameter that is too small, so that the die no longer cuts properly.

Shorter chamfer length on request.

Anwendungsempfehlungen und Schnittdaten

Richtwerte für Schnittgeschwindigkeit, Kühl-Schmiermittel und Spanwinkel.
Angaben über zu verwendende Schneideisen.

zu bearbeitende Werkstoffe	Schnittgeschwindigkeit Richtwerte in m/min	Kühl-Schmiermittel	Spanwinkel	zu verwendende Schneideisen
Allgem. Baustähle	St37-2, St50-2	8-12	Schneidöl	17-22° (HSS)
Automatenstähle	9SMn28, 9SMnPb28	10-14	Schneidöl	17-22° (HSS)
Einsatzstähle	C15, Ck15, 16MnCr5	6-10	Schneidöl, Spezial-Schneidöl	17-22° VA, VA besch., LL, LL besch.
Vergütungsstähle	C35Pb, C45	5- 8	Schneidöl, Spezial-Schneidöl	13-18° VA, VA besch., LL, LL besch.
Rost- u. säurebeständige Stähle	X12CrMoS17, X12CrNiS188	4- 6	Spezial-Schneidöl	13-18° VA, VA besch., LL, LL besch.
Grauguß	GG15, GG25	5- 8	Schneidöl, Petroleum	13-18° GG-HSS-nitr.
Messing kurzspan. Ms 58	CuZn39Pb2, CuZn40Pb2	20-30	Schneidöl	6-11° MS, MS besch.
Messing langspan. Ms 60	CuZn20, CuZn37	12-18	Schneidöl	10-15° (HSS)
Messing Ecobrass*	CuZn21S13P	8-12	Schneidöl	10-15° Ecobrass
Bronze	CuSn8	5- 8	Schneidöl, Emulsion	13-18° BZ
Rotguß	G-CuSn5ZnPb	7-11	Schneidöl, Emulsion	13-18° RG-HSS-nitr.
Kupfer	E-Cu57, SF-Cu	11-15	Schneidöl, Emulsion	23-28° CU
Alu-Leg. langspanend	AlCuMg1, AlMg3Si	15-25	Spezial-Schneidöl, Petroleum	23-28° ALU
Alu-Leg. kurzspanend	GD-ALSi8Cu3, GDAISi12	8-12	Spezial-Schneidöl, Petroleum	18-23° VA
Reintitan	Ti2	5- 8	Spezial-Schneidöl	19-24° VA, VA besch., LL, LL besch.

*bleiarms und bleifreies Messing

Schälanschnitt

Der Schälanschnitt bewirkt ein freies Abfließen der Späne nach vorne und eine Verringerung des Schnittmomentes. Spänestauungen in den Spanlöchern werden dadurch vermieden.

Das Ergebnis ist eine verbesserte Oberflächengüte bei den geschnittenen Gewinden und eine höhere Standzeit des Werkzeuges. **Schneideisen, die auf Maschinen eingesetzt werden, müssen deshalb mit Schälanschnitt bestellt werden.**

HSS-Schneideisen sind ab Gew.-Ø 3 mm mit Schälanschnitt lieferbar. Alle VA und LL werden ab Gew.-Ø 2 mm mit Schälanschnitt geliefert.

Reference of application and cutting data

Guide lines for cutting speeds, cutting fluids and rake angles.
Details for dies to be used.

material machined		cutting speed guide lines m/min	cutting fluid	rake angle	die to be used
General engineering steels	St37-2, St50-2	8-12	Cutting oil	17-22°	(HSS)
Free-cutting steels	9SMn28, 9SMnPb28	10-14	Cutting oil	17-22°	(HSS)
Case hardening steels	C15, Ck15, 16MnCr5	6-10	Cutting oil, Special cutting oil	17-22°	VA, VA coated, LL, LL coated
Heat-treatable steels	C35Pb, C45	5- 8	Cutting oil, Special cutting oil	13-18°	VA, VA coated, LL, LL coated
Stainless steels	X12CrMoS17, X12CrNiS188	4- 6	Special cutting oil	13-18°	VA, VA coated, LL, LL coated
Grey cast iron	GG15, GG25	5- 8	Cutting oil, paraffin	13-18°	GG-HSS-nitr
Brass giving short chips	CuZn39Pb2, CuZn40Pb2	20-30	Cutting oil	6-11°	MS, MS coated
Brass giving long chips	CuZn20, CuZn37	12-18	Cutting oil	10-15°	(HSS)
Ecobrass*	CuZn21S13P	8-12	Cutting oil	10-15°	Ecobrass
Bronze	CuSn8	5- 8	Cutting oil, soluble oil	13-18°	BZ
Gun metal	G-CuSn5ZnPb	7-11	Cutting oil, soluble oil	13-18°	RG-HSS-nitr.
Copper	E-Cu57, SF-Cu	11-15	Cutting oil, soluble oil	23-28°	CU
Al. alloys giving long chips	AlCuMg1, AlMg3Si	15-25	Special cutting oil, paraffin	23-28°	ALU
Al. alloys giving short chips	GD-AlSi8Cu3, GDAlSi12	8-12	Special cutting oil, paraffin	18-23°	VA
Pure titanium	Ti2	5- 8	Special cutting oil	19-24°	VA, VA coated, LL, LL coated

*low-lead and lead-free brass

Spiral entry

A spiral entry results in a free flow of chips ahead of the die and a reduction in the cutting torque. Blocking of the clearance holes by chips is avoided.

This results in an improved surface finish on the cut threads and a longer die life.

Hence dies for machine use must be ordered with spiral entry.

HSS dies can be supplied with spiral entry for threads of 3 mm dia. and above. All VA and LL dies for threads of 2 mm dia. and above are supplied with spiral entry.



M
MF
MJ
EG M

G
Rc, R
Pg

UNC
UNF
UN
UNJF

NPT
NPTF



M
MF
M keg.
M taper

G
BSW
BSF
DIN 477
R, BA, Pg

UNC
UNF
UNEF
UN, UNS

NPSM
NPT
NPTF
Tr, Rd



M
MF

G
BSW
BSF
R, Pg
MF-EL

UNC, UNF
UNEF
UN, UNS
UNJC
UNJF

NPT
NPTF
Tr
EG

Außendurchmesser-Toleranzen für Bolzengewinde

Metrisches ISO-Gewinde

Richtwerte für die Bolzenvorbereitung

4h, 6g, 6e

(Auszug aus DIN 13, Blatt 15)

ISO metric bolt diameter tolerances for external threads

Guide values for bolt preparation

4h, 6g, 6e

(excerpt from DIN 13, sheet 15)

Gewinde thread	Steigung pitch	4h			6g/6h			6e		
		Kleinstmaß min. dia.	Größtmaß max. dia.	Dreh-Ø Richtwert turning dia. target value	Kleinstmaß min. dia.	Größtmaß max. dia.	Dreh-Ø Richtwert turning dia. target value	Kleinstmaß min. dia.	Größtmaß max. dia.	Dreh-Ø Richtwert turning dia. target value
	[mm]	[mm]	[mm]	[mm]	[mm]	[mm]	[mm]	[mm]	[mm]	[mm]
M 1	0,25	0,958	1,0	0,98	0,933	1,000	0,97	0,888	0,955	0,92
M 1,1	0,25	1,058	1,1	1,08	1,033	1,100	1,07	0,988	1,055	1,02
M 1,2	0,25	1,158	1,2	1,18	1,133	1,200	1,17	1,088	1,155	1,12
M 1,4	0,3	1,352	1,4	1,38	1,325	1,400	1,36	1,279	1,354	1,31
M 1,6	0,35	1,547	1,6	1,57	1,496	1,581	1,54	1,469	1,544	1,51
M 1,8	0,35	1,747	1,8	1,77	1,696	1,781	1,74	1,669	1,754	1,71
M 2	0,4	1,940	2,0	1,97	1,886	1,981	1,94	1,857	1,952	1,90
M 2,2	0,45	2,137	2,2	2,16	2,080	2,180	2,13	2,052	2,152	2,10
M 2,5	0,45	2,437	2,5	2,46	2,380	2,480	2,43	2,352	2,452	2,40
M 3	0,5	2,933	3,0	2,96	2,874	2,980	2,92	2,844	2,950	2,89
M 3,5	0,6	3,420	3,5	3,46	3,354	3,479	3,41	3,322	3,447	3,38
M 4	0,7	3,910	4,0	3,95	3,838	3,978	3,91	3,804	3,944	3,87
M 4,5	0,75	4,410	4,5	4,45	4,338	4,478	4,41	4,304	4,444	4,37
M 5	0,8	4,905	5,0	4,95	4,826	4,976	4,90	4,790	4,940	4,86
M 6	1	5,888	6,0	5,94	5,794	5,974	5,88	5,760	5,940	5,85
M 7	1	6,888	7,0	6,94	6,794	6,974	6,88	6,760	6,940	6,85
M 8	1,25	7,868	8,0	7,93	7,760	7,972	7,87	7,725	7,937	7,83
M 10	1,5	9,850	10,0	9,92	9,732	9,968	9,85	9,697	9,933	9,81
M 12	1,75	11,830	12,0	11,92	11,701	11,966	11,83	11,664	11,929	11,80
M 14	2	13,820	14,0	13,91	13,682	13,962	13,82	13,649	13,929	13,79
M 16	2	15,820	16,0	15,91	15,682	15,962	15,82	15,649	15,929	15,79
M 18	2,5	17,788	18,0	17,89	17,623	17,958	17,79	17,585	17,920	17,75
M 20	2,5	19,788	20,0	19,89	19,623	19,958	19,79	19,585	19,920	19,75
M 22	2,5	21,788	22,0	21,89	21,623	21,958	21,79	21,585	21,920	21,75
M 24	3	23,764	24,0	23,88	23,577	23,952	23,77	23,540	23,915	23,73
M 27	3	26,764	27,0	26,88	26,577	26,952	26,77	26,540	26,915	26,73
M 30	3,5	29,735	30,0	29,87	29,522	29,947	29,73	29,485	29,910	29,70

Für ISO-Feingewinde gelten, entsprechend der Steigung, die gleichen Abmaße wie für Regelgewinde, bezogen auf den jeweiligen Gewinde-Nenn-Ø.

Die Richtwerte für die Bolzenvorbereitung Steigung 0,25 mm Toleranz 6g werden errechnet durch Subtrahieren der Tabellenwerte um das obere Abmaß 0,018 mm.

The same dimensions apply to ISO fine threads as to standard threads, according to the pitch, in relation to the respective nominal thread diameter.

The guide values for bolt preparation pitch 0.25 mm tolerance 6g are calculated by subtracting the upper dimension 0.018 mm from the table values

Außendurchmesser-Toleranzen für Bolzengewinde G und R-Gewinde

Richtwerte für die Bolzenvorbereitung und das Gewindeschneiden

G and R bolt diameter tolerances for external threads

Guide values for bolt preparation and thread cutting

Whitworth-Rohrgewinde DIN ISO 228, Toleranzfeld A Whitworth pipe thread DIN ISO 228, tolerance class A					
Gewinde thread	Gg/1" tpi	Kleinstmaß min. dia.	Größtmaß max. dia.	Dreh-Ø Richtwert turning dia. target value	
		[mm]	[mm]	[mm]	
G 1/16"	28	7,509	7,723	7,62	
G 1/8"	28	9,514	9,728	9,62	
G 1/4"	19	12,907	13,157	13,03	
G 3/8"	19	16,412	16,662	16,54	
G 1/2"	14	20,671	20,955	20,81	
G 5/8"	14	22,627	22,911	22,77	
G 3/4"	14	26,157	26,441	26,30	
G 7/8"	14	29,917	30,201	30,06	
G 1"	11	32,889	33,249	33,07	
G 1 1/8"	11	37,537	37,897	37,72	
G 1 1/4"	11	41,550	41,910	41,73	
G 1 3/8"	11	43,960	44,320	44,14	
G 1 1/2"	11	47,443	47,803	47,62	
G 1 3/4"	11	53,386	53,746	53,57	
G 2"	11	59,254	59,614	59,43	
G 2 1/4"	11	65,276	65,710	65,49	
G 2 1/2"	11	74,750	75,184	74,97	
G 2 3/4"	11	81,100	81,534	81,32	
G 3"	11	87,450	87,884	87,67	
G 3 1/2"	11	99,896	100,330	100,11	
G 4"	11	112,596	113,030	112,81	

Kegeliges Whitworth Rohrgewinde, Kegel 1:16 Tapered Whitworth pipe thread, taper 1:16					
Gewinde thread	Gg/1" tpi	Do Kleinstmaß min. Do	Do Größtmaß max. Do	Do Dreh-Ø Richtwert target Do turning dia. target value	L Richtwert target value
		[mm]	[mm]	[mm]	[mm]
R 1/8"	28	9,422	9,534	9,48	8,2
R 1/4"	19	12,700	12,863	12,78	12,1
R 3/8"	19	16,181	16,343	16,26	12,5
R 1/2"	14	20,330	20,555	20,44	16,4
R 3/4"	14	25,735	25,960	25,85	17,7
R 1"	11	32,455	32,743	32,60	20,9
R 1 1/4"	11	40,973	41,260	41,12	23,2
R 1 1/2"	11	46,866	47,153	47,01	23,2
R 2"	11	58,477	58,764	58,62	27,5

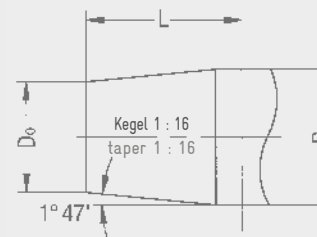

Schneideisen-Endlage (JBO-Schneideisen)
Final die position (JBO-dies)



Außendurchmesser-Toleranzen für Bolzensgewinde UNC und UNF-Gewinde

Richtwerte für die Bolzenvorbereitung
und das Gewindeschneiden

Toleranzfeld 2A

(Auszug aus ASME B1.1)

UNC and UNF bolt diameter tolerances for external threads

Guide values for bolt preparation and thread cutting

Tolerance class 2A

(excerpt from ASME B1.1)

UNC					UNF				
Gewinde thread	Gg/1" tpi	Kleinstmaß min. dia. [mm]	Größtmaß max. dia. [mm]	Dreh-Ø Richtwert turning dia. target value [mm]	Gewinde thread	Gg/1" tpi	Kleinstmaß min. dia. [mm]	Größtmaß max. dia. [mm]	Dreh-Ø Richtwert turning dia. target value [mm]
Nr. 0					Nr. 0	80	1,430	1,511	1,47
Nr. 1	64	1,742	1,839	1,79	Nr. 1	72	1,750	1,839	1,79
Nr. 2	56	2,065	2,169	2,12	Nr. 2	64	2,072	2,169	2,12
Nr. 3	48	2,383	2,497	2,44	Nr. 3	56	2,393	2,497	2,44
Nr. 4	40	2,695	2,825	2,76	Nr. 4	48	2,713	2,827	2,77
Nr. 5	40	3,025	3,155	3,09	Nr. 5	44	3,035	3,157	3,10
Nr. 6	32	3,333	3,485	3,41	Nr. 6	40	3,355	3,485	3,42
Nr. 8	32	3,991	4,143	4,07	Nr. 8	36	4,006	4,146	4,08
Nr. 10	24	4,618	4,801	4,71	Nr. 10	32	4,651	4,803	4,73
Nr. 12	24	5,278	5,461	5,37	Nr. 12	28	5,296	5,461	5,38
1/4"	20	6,116	6,322	6,22	1/4"	28	6,160	6,325	6,24
5/16"	18	7,687	7,908	7,80	5/16"	24	7,727	7,910	7,82
3/8"	16	9,253	9,492	9,37	3/8"	24	9,314	9,497	9,41
7/16"	14	10,814	11,076	10,95	7/16"	20	10,873	11,079	10,98
1/2"	13	12,385	12,662	12,52	1/2"	20	12,461	12,667	12,56
9/16"	12	13,957	14,247	14,10	9/16"	18	14,031	14,252	14,14
5/8"	11	15,527	15,834	15,68	5/8"	18	15,618	15,839	15,73
3/4"	10	18,676	19,004	18,84	3/4"	16	18,773	19,012	18,89
7/8"	9	21,824	22,177	22,00	7/8"	14	21,922	22,184	22,05
1"	8	24,968	25,349	25,16	1"	12	25,064	25,354	25,21
1 1/8"	7	28,102	28,519	28,31	1 1/8"	12	28,239	28,529	28,38
1 1/4"	7	31,277	31,694	31,49	1 1/4"	12	31,414	31,704	31,56

Außendurchmesser-Toleranzen für Bolzengewinde NPT und NPTF-Gewinde

Richtwerte für die Bolzenvorbereitung und
das Gewindeschneiden

NPT and NPTF bolt diameter tolerances for external threads
Guide values for bolt preparation and thread cutting

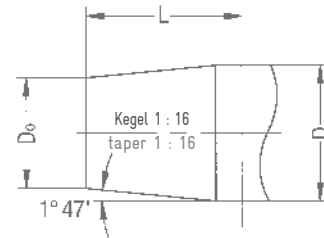

Schneideisen-Endlage (JBO-Schneideisen)
Final die position (JBO-dies)

NPT						NPTF					
Gewinde thread	Gg/1" tpi	Do Kleinstmaß min. Do [mm]	Do Größtmaß max. Do [mm]	Do Dreh-Ø Richtwert target Do turning dia. target value [mm]	L Richtwert target value [mm]	Gewinde thread	Gg/1" tpi	Do Kleinstmaß min. Do [mm]	Do Größtmaß max. Do [mm]	Do Dreh-Ø Richtwert target Do turning dia. target value [mm]	L Richtwert target value [mm]
1/16"	27	7,521	7,643	7,58	8,4	1/16"	27	7,525	7,617	7,57	8,4
1/8"	27	9,866	9,988	9,93	8,5	1/8"	27	9,870	9,962	9,92	8,5
1/4"	18	13,099	13,255	13,18	12,7	1/4"	18	13,129	13,215	13,17	12,7
3/8"	18	16,518	16,674	16,60	12,9	3/8"	18	16,548	16,634	16,59	12,9
1/2"	14	20,551	20,713	20,63	16,8	1/2"	14	20,617	20,703	20,66	16,8
3/4"	14	25,866	26,028	25,95	17,1	3/4"	14	25,932	26,018	25,98	17,1
1"	11 1/2	32,419	32,591	32,51	21,3	1"	11 1/2	32,475	32,561	32,52	21,3
1 1/4"	11 1/2	41,144	41,316	41,23	21,9	1 1/4"	11 1/2	41,200	41,286	41,24	21,9
1 1/2"	11 1/2	47,214	47,386	47,30	22,3	1 1/2"	11 1/2	47,270	47,356	47,31	22,3
2"	11 1/2	59,226	59,398	59,31	23,1	2"	11 1/2	59,282	59,368	59,33	23,1

Präzisions-Schneideisen DIN EN 22568 Metrisches ISO-Gewinde DIN 13

Precision thread cutting dies
DIN EN 22568
ISO metric thread DIN 13

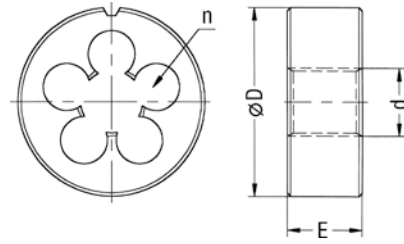
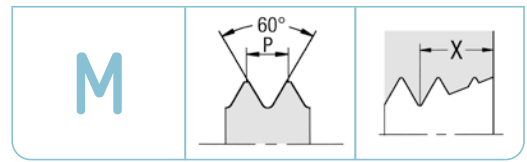

ORDER-CODE → RU →				Schäl		Autom		70°		6e		LH			
d	P mm	Ø D x E mm	n	HSS 6g ≤ M 1,4 Tol. 6h x = 1,75 · P	HSS 6g Schäl. spiral entry x = 1,75 · P	HSS 6g Schäl. ab M 3 spiral entry M 3 and above x = 1,75 · P	HSS 6g Anschn. kurz Schäl. ab M 3 short chamfer spiral entry M 3 and above x = 1,25 · P	HSS 6e Schäl. ab M 3 spiral entry M 3 and above x = 1,75 · P	HSS 6g links Schäl. ab M 3 left hand spiral entry M 3 and above x = 1,75 · P						
↓															
				Art.-Nr.	€	Art.-Nr.	€	Art.-Nr.	€	Art.-Nr.	€	Art.-Nr.	€	Art.-Nr.	€
M 1	0,25	16 x 5	3	101212	29,60										
M 1,1	0,25	16 x 5	3	101222	38,90										
M 1,2	0,25	16 x 5	3	101224	27,90										
M 1,4	0,3	16 x 5	3	101238	25,60										
M 1,6	0,35	16 x 5	3	101261	21,50										
M 1,7	0,35	16 x 5	3	101276	25,60										
M 1,8	0,35	16 x 5	3	101291	23,40										
M 2	0,4	16 x 5	3	101816	15,80										
M 2	0,4	16 x 5	4					101821	25,50	141023	○	101828	32,30	101835	29,50
M 2,2	0,45	16 x 5	3	101852	26,40										
M 2,2	0,45	16 x 5	4							s. VA S/see VA page 163					
M 2,3	0,4	16 x 5	3	101865	20,60										
M 2,3	0,4	16 x 5	4					101868	○						
M 2,5	0,45	16 x 5	3	101879	14,40										
M 2,5	0,45	16 x 5	4					101881	22,70	101895	44,00	101888	28,60	101893	29,50
M 2,6	0,45	16 x 5	3	101911	17,70										
M 2,6	0,45	16 x 5	4					101914	28,60					101921	○
M 3	0,5	20 x 5	3	102207	12,20	105131	13,40								
M 3	0,5	20 x 5	4					102210	17,20	102244	32,30	102225	20,50	105132	20,70
M 3	0,5	20 x 5	5												
M 3,5	0,6	20 x 5	3	102272	14,00	105143	15,50								
M 3,5	0,6	20 x 5	4					102275	22,40			102284	32,20	105144	41,70
M 4	0,7	20 x 5	3	102470	12,20	105234	13,40								
M 4	0,7	20 x 5	4					102473	15,90	102501	26,30	102484	19,40	105235	19,70
M 4-5	0,7	20 x 5	5							s. LL S/ see LL page 163					
M 4,5	0,75	20 x 7	4	102552	22,50	105243	24,80								
M 5	0,8	20 x 7	4	102642	12,20	105289	13,40			102676	22,30	102659	17,40	105290	17,70
M 5-5	0,8	20 x 7	5							s. LL S/ see LL page 163					

→ gel, für geläppte Ausführung 20% Zuschlag

○ am Lager, Preis auf Anfrage

→ gel, for lapped threads 20% extra charge

○ in stock, price on request

Präzisions-Schneideisen DIN EN 22568 Metrisches ISO-Gewinde DIN 13

Precision thread cutting dies
DIN EN 22568
ISO metric thread DIN 13

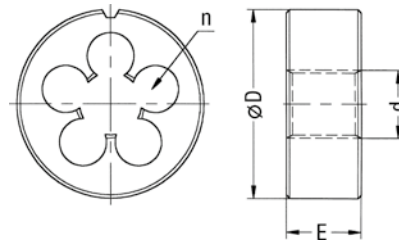
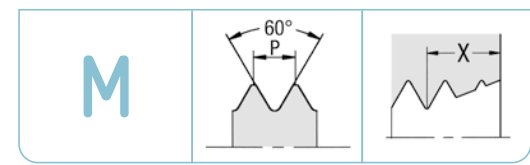

ORDER-CODE → RU →				MS	VA	6e-VA	LL (Long Life)		
d	P mm	Ø D x E mm	n	HSS 6g Messing, geläpft, Schäl. ab M 3 brass, lapped, spiral entry M 3 and above $x = 1,25 \cdot P$	HSSE 6g Schäl., geläpft, spiral entry, lapped $\geq M 3$ nitr. $x = 2 \cdot P$	HSSE 6e Schäl., geläpft, nitr. spiral entry, lapped, nitrided $x = 2 \cdot P$	HSSE 6g Schäl., geläpft, nitr. spiral entry, lapped, nitrided $x = 2,25 \cdot P$		
↓									
				Art.-Nr.	€	Art.-Nr.	€	Art.-Nr.	€
M 1	0,25	16 x 5	3			siehe S/ see page 167			
M 1,1	0,25	16 x 5	3						
M 1,2	0,25	16 x 5	3						
M 1,4	0,3	16 x 5	3			siehe Seite 167 see page 167			
M 1,6	0,35	16 x 5	3						
M 1,7	0,35	16 x 5	3						
M 1,8	0,35	16 x 5	3						
M 2	0,4	16 x 5	3						
M 2	0,4	16 x 5	4	101822	35,70	104225	29,70	siehe S/ see page 167	siehe S/ see page 167
M 2,2	0,45	16 x 5	3						
M 2,2	0,45	16 x 5	4			104239	○		
M 2,3	0,4	16 x 5	3						
M 2,3	0,4	16 x 5	4			104242	35,40		
M 2,5	0,45	16 x 5	3						
M 2,5	0,45	16 x 5	4	101882	30,40	104245	28,00	104773	36,10
M 2,6	0,45	16 x 5	3						
M 2,6	0,45	16 x 5	4	101915	○	104255	31,70		
M 3	0,5	20 x 5	3						
M 3	0,5	20 x 5	4	102213	23,80	104306	20,00	104310	50,30
M 3	0,5	20 x 5	5					104776	30,50
M 3,5	0,6	20 x 5	3						
M 3,5	0,6	20 x 5	4	102277	34,30	104332	24,20		
M 4	0,7	20 x 5	3						
M 4	0,7	20 x 5	4	102475	21,60	104373	19,40	104381	43,90
M 4	0,7	20 x 5	5			siehe LL/ see LL		104781	29,30
M 4,5	0,75	20 x 7	4			104402	○		
M 5	0,8	20 x 7	4	102645	22,00	104418	17,30	104423	27,20
M 5	0,8	20 x 7	5			siehe LL/ see LL		104784	28,20

○ am Lager, Preis auf Anfrage
Preise für weitere Ausführungen auf Anfrage







○ in stock, price on request
Prices for further versions on request

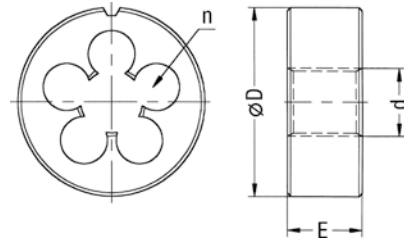
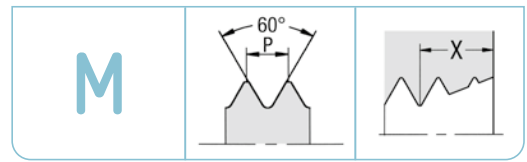

Präzisions-Schneideisen DIN EN 22568 Metrisches ISO-Gewinde DIN 13

Precision thread cutting dies
DIN EN 22568
ISO metric thread DIN 13



ORDER-CODE → RU →				Schäl		Autom		70°		6e		LH			
d	P mm	Ø D x E mm	n	HSS 6g x = 1,75 · P 	HSS 6g Schäl. spiral entry x = 1,75 · P 	HSS 6g Schäl. spiral entry x = 1,75 · P 	HSS 6g Anschn. kurz Schäl. short chamfer spiral entry x = 1,25 · P 	HSS 6e Schäl. spiral entry x = 1,75 · P 	HSS 6g links Schäl. left hand spiral entry x = 1,75 · P 						
↓				Art.-Nr.	€	Art.-Nr.	€	Art.-Nr.	€	Art.-Nr.	€	Art.-Nr.	€		
M 6	1	20 x 7	4	102771	12,20	105347	13,40			102797	20,20	102785	17,40	105348	17,70
M 6-5	1	20 x 7	5					102773	20,80						
M 7	1	25 x 9	4	102888	15,10	105391	16,70					102895	30,30	105392	31,40
M 8	1,25	25 x 9	4	102959	13,50	105419	14,70					102975	19,30	105420	19,40
M 8	1,25	25 x 9	5					102961	21,80	102990	30,90	102978	○		
M 9	1,25	25 x 9	4	103098	17,30	105450	19,10							105451	○
M 9	1,25	25 x 9	5												
M 10	1,5	30 x 11	4	101297	16,10	104875	17,70					101314	23,10	104876	23,50
M 10	1,5	30 x 11	5					101300	24,70	101326	36,40				
M 11	1,5	30 x 11	4	101411	22,20	104897	24,30							104898	○
M 11	1,5	30 x 11	5												
M 12	1,75	38 x 14	4	101439	21,40	104908	23,50					101447	30,70	104909	31,00
M 12	1,75	38 x 14	5					101442	30,90	101458	○				
M 14	2	38 x 14	4	101558	21,80	104936	24,00					101566	○	104937	33,00
M 14	2	38 x 14	5					s. VA S/ see VA page 165							
M 16	2	45 x 18	4	101657	27,70	104965	30,50					101665	50,60	104966	40,60
M 16	2	45 x 18	5					s. VA S/ see VA page 165							
M 18	2,5	45 x 18	5	101746	29,50	104987	32,50							104988	55,20
M 20	2,5	45 x 18	5	101934	29,50	105025	32,50					101938	○	105026	42,80
M 22	2,5	55 x 22	5	102002	42,20	105051	46,50							105052	78,60
M 22	2,5	55 x 22	6												
M 24	3	55 x 22	5	102060	42,20	105072	46,50							105073	61,10
M 24	3	55 x 22	6												
M 27	3	65 x 25	5	102150	63,70	105107	70,10							105108	111,00
M 27	3	65 x 25	6												
M 30	3,5	65 x 25	6	102316	63,70	105152	70,10							105153	95,70
M 33	3,5	65 x 25	6	102372	71,10	105179	78,20							105180	○
M 36	4	65 x 25	7	102415	67,80	105205	74,50							105206	○
M 39	4	75 x 30	6	102455	113,00	105227	124,00								

→ gel, für geläppte Ausführung 20% Zuschlag
○ am Lager, Preis auf Anfrage

→ gel, for lapped threads 20% extra charge
○ in stock, price on request



Präzisions-Schneideisen DIN EN 22568 Metrisches ISO-Gewinde DIN 13

Precision thread cutting dies
DIN EN 22568
ISO metric thread DIN 13

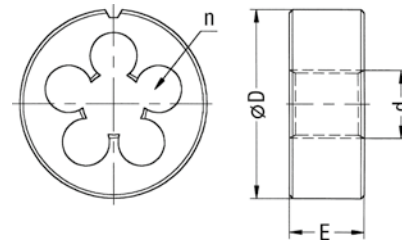
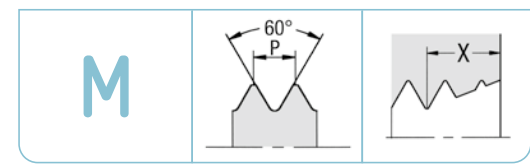

ORDER-CODE → RU →				MS	VA	6e-VA	LL (Long Life)		
d	P mm	Ø D x E mm	n	HSS 6g Messing geläppt, Schäl. brass lapped, spiral entry x = 1,25 · P	HSSE 6g Schäl., geläppt, nitr. spiral entry, lapped, nitrided x = 2 · P	HSSE 6e Schäl., geläppt, nitr. spiral entry, lapped, nitrided x = 2 · P	HSSE 6g Schäl., geläppt, nitr. spiral entry, lapped, nitrided x = 2,25 · P		
↓									
				Art.-Nr.	€	Art.-Nr.	€	Art.-Nr.	€
M 6	1	20 x 7	4	102774	19,50	104453	17,30	104462	25,90
M 6	1	20 x 7	5			siehe LL/ see LL		104789	27,40
M 7	1	25 x 9	4	102891	37,80	104496	30,40		
M 8	1,25	25 x 9	4	102962	21,80				
M 8	1,25	25 x 9	5			104511	21,10	104516	31,00
M 9	1,25	25 x 9	4						
M 9	1,25	25 x 9	5			104545	○		
M 10	1,5	30 x 11	4	101301	27,30				
M 10	1,5	30 x 11	5			104060	24,90	104063	38,70
M 11	1,5	30 x 11	4						
M 11	1,5	30 x 11	5			104097	○		
M 12	1,75	38 x 14	4	101443	40,90				
M 12	1,75	38 x 14	5			104106	32,80	104112	55,00
M 14	2	38 x 14	4	101562	○				
M 14	2	38 x 14	5			104147	36,30	104149	○
M 16	2	45 x 18	4	101660	○				
M 16	2	45 x 18	5			104179	43,50	104181	○
M 18	2,5	45 x 18	5			104201	47,80		
M 20	2,5	45 x 18	5	101935	○	104260	44,50		
M 22	2,5	55 x 22	5						
M 22	2,5	55 x 22	6			104272	73,30		
M 24	3	55 x 22	5						
M 24	3	55 x 22	6			104281	66,50		
M 27	3	65 x 25	5						
M 27	3	65 x 25	6			104298	133,00		
M 30	3,5	65 x 25	6			104346	133,00		
M 33	3,5	65 x 25	7			104357	○		
M 36	4	65 x 25	7			104365	○		
M 39	4	75 x 30	6						

○ am Lager, Preis auf Anfrage

* mit 6 Spanlöchern

Preise für weitere Ausführungen auf Anfrage

○ in stock, price on request

* with 6 chip holes

Prices for further versions on request



Präzisions-Schneideisen
DIN EN 22568
Metrisches ISO-Gewinde DIN 13

Precision thread cutting dies
DIN EN 22568
ISO metric thread DIN 13

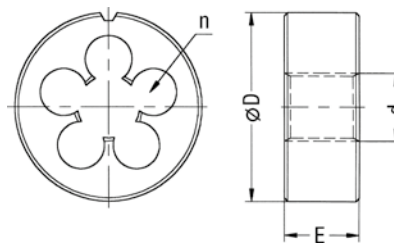

ORDER-CODE → RU →				Schäl		Autom		70°		6e		LH			
d	P mm	Ø D x E mm	n	HSS 6g	HSS 6g Schäl. spiral entry	HSS 6g Schäl. spiral entry	HSS 6g Schäl. spiral entry	HSS 6g Anschn. kurz Schäl. short chamfer spiral entry	HSS 6e Schäl. spiral entry	HSS 6g links Schäl. left hand spiral entry					
				$x = 1,75 \cdot P$	$x = 1,75 \cdot P$	$x = 1,75 \cdot P$	$x = 1,75 \cdot P$	$x = 1,25 \cdot P$	$x = 1,75 \cdot P$	$x = 1,75 \cdot P$					
				Art.-Nr.	€	Art.-Nr.	€	Art.-Nr.	€	Art.-Nr.	€	Art.-Nr.	€	Art.-Nr.	€
M 42	4,5	75 x 30	7	102587	113,00	105255	124,00							105256	○
M 45	4,5	90 x 36	7	108325	177,00	105270	195,00								
M 48	5	90 x 36	7	102630	169,00	105281	186,00								
M 52	5	90 x 36	7	102740	178,00	105321	196,00								
M 56	5,5	105 x 36	7	102757	○	105334	○								
M 60	5,5	105 x 36	8	102863	○	105368	○								
M 64	6	105 x 36	8	102872	○	105378	○								

➔ gel, für geläppte Ausführung 20% Zuschlag
○ am Lager, Preis auf Anfrage

➔ gel, for lapped threads 20% extra charge
○ in stock, price on request



Präzisions-Schneideisen mit Sonderbaumaßen

Metrisches ISO-Gewinde DIN 13

Ausführung: Anschnitt beidseitig, geläppt

Precision thread cutting dies
with special outside dimensions
ISO metric thread DIN 13
Specification: chamfered on both sides, lapped

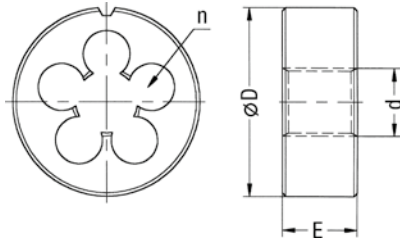
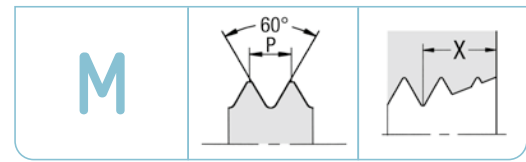

ORDER-CODE → RU →				6e		VA		6e-VA		LL (Long Life)	
d	P mm	Ø D x E mm	n	HSS 6g Schäl. ab M 3 spiral entry M 3 and above ≤ M 1,4 Tol. 6h x = 1,75 · P	HSS 6e Schäl. ab M 3 spiral entry M 3 and above x = 1,75 · P	HSSE 6g Schäl. ab M 2 spiral entry M 2 and above ≥ M 3 nitr. ≤ M 1,4 Tol. 6h x = 2 · P	HSSE 6e Schäl. spiral entry ≥ M 3 nitr. x = 2 · P	HSSE 6g Schäl. spiral entry ≥ M 3 nitr. x = 2,25 · P			
↓											
				Art.-Nr.	€	Art.-Nr.	€	Art.-Nr.	€	Art.-Nr.	€
M 1	0,25	16 x 2	3	101214	○			104035	○		
M 1,2	0,25	16 x 2	3	101226	○			104040	○		
M 1,4	0,3	12 x 2,6	4	101239	○						
M 1,4	0,3	16 x 2,6	4	101240	42,60			104044	41,10		
M 1,6	0,35	12 x 2,6	4	101262	○						
M 1,6	0,35	16 x 2,6	4	101263	40,60			104049	39,80		
M 1,7	0,35	12 x 2,6	4	101277	○						
M 1,7	0,35	16 x 2,6	4	101278	○			104053	39,80		
M 1,8	0,35	16 x 2,6	4	101293	○			104056	○		
M 2	0,4	12 x 3,5	4	101817	48,10						
M 2	0,4	16 x 3,5	4					104223	33,80	104228	○
M 2,2	0,45	16 x 3,5	4					104238	○		
M 2,3	0,4	12 x 3	4								
M 2,3	0,4	16 x 3,5	4					104240	40,20		
M 2,5	0,45	12 x 3,5	4	101880	○						
M 2,6	0,45	12 x 3,5	4								
M 3	0,5	12 x 4	4	102208	40,60			141027	○		
M 3	0,5	16 x 5	4	102209	21,10	102227	24,70	104307	24,20	104312	34,00
M 3,5	0,6	16 x 5	4	102274	37,30	102285	○	104333	○		
M 4	0,7	16 x 5	4	102472	21,90	102485	28,10	104374	23,80	104382	36,40
M 5	0,8	16 x 5	4	102643	27,90	102660	37,30	104419	37,30	104424	○
M 6	1	16 x 5	5	102772	31,40	102786	○	104454	○	104463	○
M 7	1	20 x 7	5	102889	○						
M 8	1,25	20 x 7	5	102960	33,30	102976	43,10	104512	38,30	104517	○
M 10	1,5	25 x 9	5	101299	31,80	101316	○	104061	42,80	104064	○
M 12	1,75	25 x 9	5	101440	○						
M 12	1,75	30 x 11	5	101441	○						

○ am Lager, Preis auf Anfrage

* mit 5 Spanlöchern

Preise für weitere Ausführungen auf Anfrage

○ in stock, price on request

* with 5 chip holes

Prices for further versions on request



Präzisions-Schneideisen mit Aufschraubblöchern

Metrisches ISO-Gewinde DIN 13

Ausführung: Anschnitt beidseitig, geläppt

Precision thread cutting dies
with two fixing holes
ISO metric thread DIN 13
Specification: chamfered on both sides, lapped

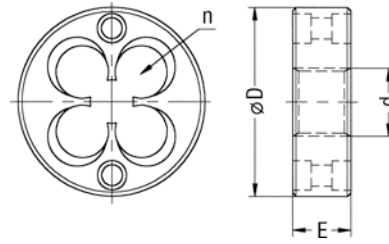

ORDER-CODE → ASL →				6e		MS		VA			
d	P mm	Ø D x E mm	n	HSS 6g Schäl. ab M 3 spiral entry M 3 and above ≤ M 1,4 Tol. 6h x = 1,75 · P	HSS 6e Schäl. ab M 3 spiral entry M 3 and above x = 1,75 · P	HSS 6g Messing Schäl. ab M 3 brass spiral entry M 3 and above x = 1,25 · P	HSSE 6g Schäl. ab M 2 spiral entry M 2 and above ≥ M 3 nitr. x = 2 · P				
				Art.-Nr.	€	Art.-Nr.	€	Art.-Nr.	€	Art.-Nr.	€
M 1	0,25	16 x 2	3	100036	○						
M 1,1	0,25	16 x 2	3	100039	○						
M 1,2	0,25	16 x 2	3	100040	○						
M 1,4	0,3	16 x 2,6	4	100046	40,80						
M 1,6	0,35	16 x 2,6	4	100058	34,80	100061	○				
M 1,7	0,35	16 x 2,6	4	100068	42,40						
M 1,8	0,35	16 x 2,6	4	100075	○						
M 2	0,4	16 x 3,5	4	100166	28,10	100169	○	100168	○	100470	○
M 2	0,4	12 x 3,5	4	100167	○						
M 2,2	0,45	16 x 3,5	4	100180	○						
M 2,3	0,4	16 x 3,5	4	100183	36,20						
M 2,5	0,45	16 x 3,5	4	100188	24,70	100195	34,40	100190	○	100475	37,70
M 2,5	0,45	12 x 3,5	4	100189	○						
M 2,6	0,45	16 x 3,5	4	100207	30,80						
M 3	0,5	16 x 3,5	4	100221	19,10	100227	22,90	100224	○	100479	25,60
M 3,5	0,6	16 x 4	4	100238	23,90	100242	○			100484	○
M 4	0,7	16 x 5	4	100251	18,80	100257	23,40	100253	○	100488	27,50
M 4	0,7	20 x 5	4	100252	24,40					100489	○
M 4,5	0,75	20 x 7	4	100275	○						
M 5	0,8	20 x 7	4	100280	17,40	100286	20,80	100282	○	100494	27,40
M 6	1	20 x 7	4	100308	17,40	100314	20,80	100310	○	100496	25,50
M 7	1	25 x 7	4	100329	29,70	100331	○				
M 8	1,25	25 x 9	4	100337	20,30	100342	24,00			100511	30,10
M 10	1,5	30 x 11	6	100079	35,60	100082	39,90			100456	○
M 10	1,5	25 x 9	4	100080	29,80						
M 12	1,75	35 x 12	6	100109	○	100112	○				
M 12	1,75	30 x 11	6	100108	39,50	100111	○				
M 14	2	35 x 14	6	100137	○						
M 16	2	45 x 18	6	100151	○						

○ am Lager, Preis auf Anfrage
Preise für weitere Ausführungen auf Anfrage

○ in stock, price on request
Prices for further versions on request

Präzisions-Glockenschneideisen Metrisches ISO-Gewinde DIN 13

Ausführung: geläppt

Precision bell form thread cutting dies
ISO metric thread DIN 13
Specification: lapped

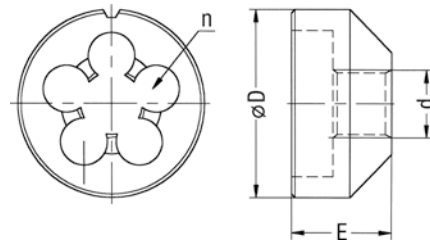
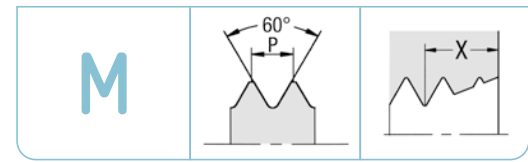
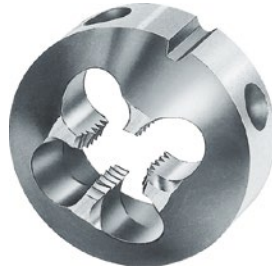

ORDER-CODE → GL →				6e		MS		VA			
d	P mm	Ø D x E mm	n	HSS 6g Schäl. ab M 3 spiral entry M 3 and above x = 1,75 · P	HSS 6e Schäl. ab M 3 spiral entry M 3 and above x = 1,75 · P	HSS 6g Messing Schäl. ab M 3 brass spiral entry M 3 and above x = 1,25 · P	HSSE 6g Schäl. ab M 2, spiral entry M 2 and above, ≥ M 3 nitr. x = 2 · P				
↓		↓									
				Art.-Nr.	€	Art.-Nr.	€	Art.-Nr.	€	Art.-Nr.	€
M 2	0,4	16 x 8	4	100618	33,80	100619	○			100755	○
M 2,2	0,45	16 x 8	4	100621	○						
M 2,3	0,4	16 x 8	4	100622	○					108129	○
M 2,5	0,45	16 x 8	4	100626	33,50	100627	○			100756	○
M 2,6	0,45	16 x 8	4	100629	○					100757	○
M 3	0,5	16 x 8	4	100642	29,50	100647	30,40	100644	○	100759	37,90
M 3	0,5	20 x 9,5	4	100643	○	100648	○				
M 3,5	0,6	16 x 9,5	4	100653	○	108107	○				
M 4	0,7	16 x 9,5	4	100659	29,20	100663	32,40	100661	○	100766	37,20
M 4	0,7	20 x 9,5	4	100660	34,10	100664	○			100767	○
M 5	0,8	16 x 9,5	4	100672	30,30	100675	35,00	100674	○	100771	○
M 5	0,8	20 x 9,5	4	100673	31,80	100676	○			100772	○
M 6	1	16 x 9,5	5	100681	30,00	100685	○	108115	○	100776	○
M 6	1	20 x 9,5	4	100682	30,90	100686	○			100777	○
M 8	1,25	25 x 14	5	100700	39,70	100705	○	100702	○	100781	○
M 10	1,5	25 x 14	5	100578	○	100581	○				
M 12	1,75	30 x 18	5	100591	○						

○ am Lager, Preis auf Anfrage

Preise für weitere Ausführungen auf Anfrage

Schneideisen für größere Gewinde können wir preisgünstig anbieten, wenn folgende Außenmaße verwendet werden:

Ø 38 x 20, Ø 45 x 24, Ø 55 x 28 und Ø 65 x 30 mm

○ in stock, price on request

Prices for further versions on request

We can supply dies for larger threads at competitive prices provided that they conform to the following external dimensions: Ø 38 x 20, Ø 45 x 24, Ø 55 x 28 and Ø 65 x 30 mm

Sechskantschneideisen DIN 382 Metrisches ISO-Gewinde DIN 13

Hexagon die nuts
DIN 382
ISO metric thread DIN 13

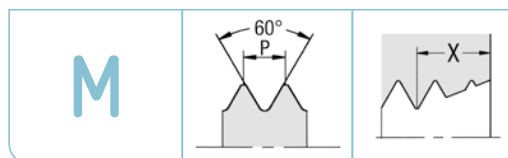
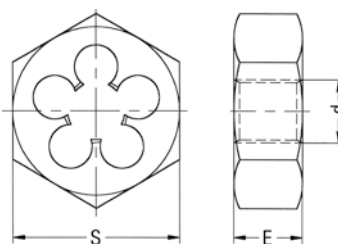

ORDER-CODE → SK →			Schäl			
d	P mm	S x E mm	HSS 6g		HSS 6g Schäl. spiral entry	
			x = 1,65 · P		x = 1,65 · P	
			Art.-Nr.	€	Art.-Nr.	€
M 3	0,5	18 x 5	120260	15,10	120957	16,60
M 3,5	0,6	18 x 5	120264	○	120958	○
M 4	0,7	18 x 5	120319	14,70	120976	16,20
M 5	0,8	18 x 7	120370	14,50	120988	16,00
M 6	1	18 x 7	120418	14,50	120995	16,00
M 7	1	21 x 9	120457	○	121004	○
M 8	1,25	21 x 9	120486	15,50	121008	17,10
M 9	1,25	21 x 9	120515	○	121015	○
M 10	1,5	27 x 11	120082	19,40	120915	21,30
M 11	1,5	27 x 11	120099	○	120920	○
M 12	1,75	36 x 14	120108	25,70	120922	28,30
M 14	2	36 x 14	120128	26,30	120927	29,00
M 16	2	41 x 18	120151	33,10	120932	36,50
M 18	2,5	41 x 18	120170	34,40	120937	37,80
M 20	2,5	41 x 18	120191	34,40	120943	37,80
M 22	2,5	50 x 22	120205	53,80	120947	59,20
M 24	3	50 x 22	120220	50,50	120949	55,40
M 27	3	60 x 25	120243	78,70	120953	86,70
M 30	3,5	60 x 25	120267	78,70	120960	86,70
M 33	3,5	60 x 25	120284	84,20	120965	92,70
M 36	4	60 x 25	120299	82,30	120969	90,60
M 39	4	70 x 30	120314	129,00	120973	142,00
M 42	4,5	70 x 30	120335	124,00	120978	136,00
M 45	4,5	85 x 36	120347	201,00	120982	221,00
M 48	5	85 x 36	120360	189,00	120984	208,00
M 52	5	85 x 36	120387	202,00	121146	222,00
M 56	5,5	100 x 36	120404	○	120993	○
M 60	5,5	100 x 36	120426	○	120998	○
M 64	6	115 x 36	120437	○	121001	○

○ am Lager, Preis auf Anfrage

○ in stock, price on request



Präzisions-Schneideisen
DIN EN 22568
Metrisches ISO-Feingewinde DIN 13

Precision thread cutting dies
DIN EN 22568
ISO metric fine thread DIN 13

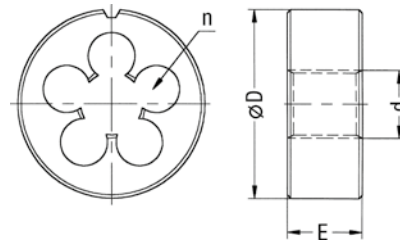
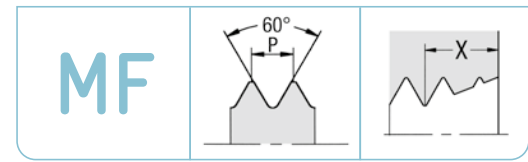

ORDER-CODE → RU →				1		2		3		4		5		6	
d	P mm	Ø D x E mm	n	HSS 6g		HSS 6g Schäl. spiral entry		HSS 6e Schäl. ab M 3 spiral entry M 3 and above		HSS 6g links Schäl. ab M 3 left hand spiral entry M 3 and above		HSS 6g Messing geläpft, Schäl. ab M 3 brass lapped, spiral entry M 3 and above		HSSE 6g Schäl., geläpft, spiral entry, lapped, P ≥ 0,5 nitr. x = 2 · P	
↓	↓			x = 1,75 · P		x = 1,75 · P		x = 1,75 · P		x = 1,75 · P		x = 1,25 · P		x = 2 · P	
				Art.-Nr.	€	Art.-Nr.	€	Art.-Nr.	€	Art.-Nr.	€	Art.-Nr.	€	Art.-Nr.	€
M 2	0,25	16 x 5	4	143220	40,60					146493	○	106665	○		
M 2,2	0,25	16 x 5	4	146271	○										
M 2,3	0,25	16 x 5	4	146272	○										
M 2,5	0,25	16 x 5	4	143225	○							146494	○		
M 3	0,25	20 x 5	4			146273	○								
M 3,5	0,25	20 x 5	4			106777	○								
M 4	0,25	20 x 5	4			146274	○								
M 2,5	0,35	16 x 5	4	101906	32,50			101908	○	101909	○	101907	○	104252	○
M 3	0,35	20 x 5	4			105138	23,00	102265	○	105139	○	102261	○	104329	○
M 3,5	0,35	20 x 5	4			105147	30,00	102304	○	105148	○			104341	○
M 4	0,35	20 x 5	4			105237	25,50	102522	○	105238	○	102517	○	104395	○
M 4,5	0,35	20 x 5	4			105245	○								
M 5	0,35	20 x 5	4			105294	39,60					108334	○		
M 6	0,35	20 x 5	5			105352	○					108353	○		
M 4	0,5	20 x 5	4			105239	18,10	102538	○	105240	41,10	102532	31,30	104397	32,60
M 4,5	0,5	20 x 5	4			105246	26,10					108316	○	104405	○
M 5	0,5	20 x 5	4			105295	17,70	102699	34,60	105296	32,60	102692	35,20	104437	26,20
M 5,5	0,5	20 x 5	4			105305	38,80					102722	○		
M 6	0,5	20 x 5	4			105353	17,70	102814	36,20	105354	32,60	102808	29,70	104475	25,00
M 7	0,5	25 x 9	4			105395	31,40	102912	○			102909	○	104500	○
M 8	0,5	25 x 9	5			105425	26,20	103005	53,40	105426	49,70	103002	○	104526	48,50
M 9	0,5	25 x 9	5			105452	36,30			105453	○	103108	○	104549	○
M 10	0,5	30 x 11	5			104879	33,20	108168	○	104880	○	101335	○	104073	○
M 11	0,5	30 x 11	5			104899	54,80							104099	○
M 12	0,5	38 x 10	5			104911	43,00			104912	○	101466	○	104119	○
M 13	0,5	38 x 10	5			104927	○								
M 14	0,5	38 x 10	5			104939	57,00							104152	○
M 15	0,5	38 x 10	6			104955	○								
M 16	0,5	45 x 14	5			104969	71,50					101673	○	104184	○

Spalte 1-4 → gel, für geläppte Ausführung 20% Zuschlag
○ am Lager, Preis auf Anfrage
Preise für weitere Ausführungen auf Anfrage
70° (kurzer Anschnitt) auf Anfrage

Columns 1-4 → gel, for lapped threads 20% extra charge
○ in stock, price on request
Prices for further versions on request
70° (short chamfer) on request



M
MF
MJ
EG M

G
Rc, R
Pg

UNC
UNF
UN
UNJF

NPT
NPTF

M
MF
M keg.
M taper

G
BSW
BSF
DIN 477
R, BA, Pg

UNC
UNF
UNEF
UN, UNS

NPSM
NPT
NPTF
Tr, Rd

M
MF

G
BSW
BSF
R, Pg
MF-EL

UNC, UNF
UNEF
UN, UNS
UNJC
UNJF

NPT
NPTF
Tr
EG

Präzisions-Schneideisen DIN EN 22568 Metrisches ISO-Feingewinde DIN 13

Precision thread cutting dies
DIN EN 22568
ISO metric fine thread DIN 13

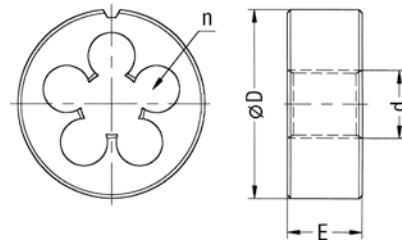

ORDER-CODE → RU →				1		2		3		4		5		6	
d	P mm	Ø D x E mm	n	HSS 6g		HSS 6g Schäl. spiral entry		HSS 6e Schäl. spiral entry		HSS 6g links Schäl. left hand spiral entry		HSS 6g Messing geläppt, Schäl. brass lapped, spiral entry		HSSE 6g Schäl., geläppt, nitr. spiral entry, lapped, nitrided	
				x = 1,75 · P		x = 1,75 · P		x = 1,75 · P		x = 1,75 · P		x = 1,25 · P		x = 2 · P	
↓	↓														
				Art.-Nr.	€	Art.-Nr.	€	Art.-Nr.	€	Art.-Nr.	€	Art.-Nr.	€	Art.-Nr.	€
M 17	0,5	45 x 14	5			108586	○								
M 18	0,5	45 x 14	6			104990	○								
M 20	0,5	45 x 14	7			105028	103,00								
M 4	0,75	20 x 7	4			105242	○								
M 5	0,75	20 x 7	4			105298	35,20	102711	○	108634	○	102710	○		
M 6	0,75	20 x 7	4	102822	16,00	105356	17,60	102830	29,60	105357	29,00	102825	27,90	104481	23,10
M 7	0,75	25 x 9	4			105398	19,90	102927	37,70	105399	○	102920	41,20	104501	○
M 8	0,75	25 x 9	4	103012	17,00	105427	18,70	103020	31,90	105428	37,30	103015	34,60	104528	27,40
M 9	0,75	25 x 9	5			105455	26,80	103119	○						
M 10	0,75	30 x 11	5	101339	22,40	104882	24,60	101346	66,10	104883	55,30	101341	48,70	104076	33,60
M 11	0,75	30 x 11	5			104900	36,40								
M 12	0,75	38 x 10	5	101472	31,60	104913	34,70	101477	45,70	104914	○	101475	○	104123	○
M 13	0,75	38 x 10	5			104929	53,60			104930	○	108197	○		
M 14	0,75	38 x 10	5			104941	32,80	101580	○	104942	○			104153	○
M 15	0,75	38 x 10	5			104957	53,10							104173	○
M 16	0,75	45 x 14	5			104970	62,00	101681	○	104971	○			104185	○
M 18	0,75	45 x 14	6			104991	70,20							104206	○
M 19	0,75	45 x 14	6			105007	98,30								
M 20	0,75	45 x 14	6			105030	91,90							108520	○
M 21	0,75	45 x 14	7			105042	130,00								
M 5.5	0,9	20 x 7	4			105302	○			105303	○			104442	○
M 8	1	25 x 9	4	103033	16,80	105431	18,40	103048	24,20	105432	24,00	103037	24,00	104533	23,70
M 9	1	25 x 9	5			105457	23,30	103127	○	105458	○	103125	○	104552	○
M 10	1	30 x 11	5	101355	20,20	104885	22,20	101366	27,20	104886	28,20	101357	28,50	104080	28,40
M 11	1	30 x 11	5	101421	22,30	104902	24,80	101425	○	104903	○	101423	○	104104	○
M 12	1	38 x 10	5	101484	26,30	104916	29,00	101498	35,80	104917	37,10	101487	37,10	104126	36,80
M 13	1	38 x 10	5	101542	28,20	104932	31,00	101549	○	104933	○	101544	43,40	104143	○
M 14	1	38 x 10	5	101584	26,50	104944	29,20	101591	38,90	104945	37,80	101586	40,60	104158	37,60
M 15	1	38 x 10	5	101634	27,90	104959	30,70	101642	○	104960	○	101637	43,90	104174	○

Spalte 1-4 → gel, für geläppt Ausführung 20% Zuschlag
○ am Lager, Preis auf Anfrage
Preise für weitere Ausführungen auf Anfrage
70° (kurzer Anschnitt) auf Anfrage

Columns 1-4 → gel, for lapped threads 20% extra charge
○ in stock, price on request
Prices for further versions on request
70° (short chamfer) on request



Präzisions-Schneideisen DIN EN 22568 Metrisches ISO-Feingewinde DIN 13

Precision thread cutting dies
DIN EN 22568
ISO metric fine thread DIN 13

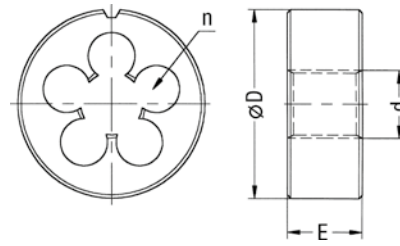
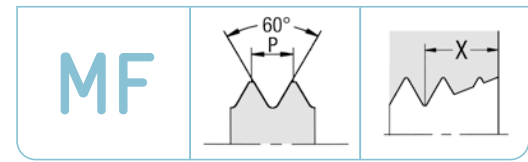

ORDER-CODE → RU →				1		2		3		4		5		6	
d	P	Ø D x E	n	HSS 6g		Schäl. HSS 6g Schäl. spiral entry		HSS 6e Schäl. spiral entry		HSS 6g links Schäl. left hand spiral entry		HSS 6g Messing geläppt, Schäl. brass lapped, spiral entry		HSSE 6g Schäl., geläppt, nitr. spiral entry, lapped, nitrided	
↓	↓			x = 1,75 · P		x = 1,75 · P		x = 1,75 · P		x = 1,75 · P		x = 1,25 · P		x = 2 · P	
				Art.-Nr.	€	Art.-Nr.	€	Art.-Nr.	€	Art.-Nr.	€	Art.-Nr.	€	Art.-Nr.	€
M 16	1	45 x 14	5	101686	36,60	104972	40,40	101692	55,70	104973	51,60	101687	54,80	104187	50,90
M 17	1	45 x 14	5	101727	42,20	104982	46,50	101732	○	108587	○	101729	○	104198	○
M 18	1	45 x 14	5	101764	36,60	104994	40,40	101770	77,90	104995	78,70	101766	60,70	104207	66,40
M 19	1	45 x 14	6			105009	51,70	101807	○	105010	○	101806	○		
M 20	1	45 x 14	6	101951	36,60	105032	40,40	101959	77,90	105033	54,80	101953	55,70	104263	60,00
M 21	1	45 x 14	7			105043	56,20	106151	○			101995	○		
M 22	1	55 x 16	6	102014	48,90	105056	53,80	102020	112,00	105057	126,00	102016	88,10	104274	○
M 23	1	55 x 16	6			105068	89,90								
M 24	1	55 x 16	6	102072	48,90	105077	53,80	102080	○	105078	104,00	102074	○	104283	○
M 25	1	55 x 16	6	102107	61,50	105092	67,70	102110	○	105093	○	102109	114,00	104290	○
M 26	1	55 x 16	7	102134	61,50	105100	67,70					102135	101,00	104295	○
M 27	1	65 x 18	6			105110	86,90	102159	○						
M 28	1	65 x 18	6			105118	83,70	102181	○	106167	○	102179	○		
M 30	1	65 x 18	7	102323	74,30	105155	81,70			105156	○	102324	○	104347	○
M 32	1	65 x 18	7			105170	99,20								
M 34	1	65 x 18	8			105189	121,00								
M 36	1	65 x 18	8	102420	107,00	105207	118,00								
M 10	1,25	30 x 11	4	101387	22,10	104887	24,10	101392	○	104888	32,90	101390	○	104090	49,10*
M 11	1,25	30 x 11	5			104904	35,00					141039	○	104105	○
M 12	1,25	38 x 10	4	101508	27,40	104918	30,30	101514	○	104919	40,50	101512	○	104135	55,80*
M 14	1,25	38 x 10	5	101596	27,70	104948	30,50	101599	○	104949	49,90	101597	○	104162	○
M 16	1,25	45 x 14	5			104974	48,00							104190	○
M 18	1,25	45 x 14	5			104996	55,60							104210	○
M 20	1,25	45 x 14	6			105034	○								
M 12	1,5	38 x 10	4	101519	24,30	104920	26,70	101527	33,60	104921	35,90	101522	39,40		
M 12	1,5	38 x 10	5											104136	35,20
M 14	1,5	38 x 10	5	101601	24,30	104950	26,70	101611	33,60	104951	34,70	101603	43,90	104166	35,20
M 15	1,5	38 x 10	5			104962	35,40			104963	○	101650	○	104177	○
M 16	1,5	45 x 14	5	101704	33,20	104975	36,50	101711	45,40	104976	47,10	101706	52,30	104192	48,40

Spalte 1-4 → gel, für geläppt Ausführung 20% Zuschlag
○ am Lager, Preis auf Anfrage
Preise für weitere Ausführungen auf Anfrage
70° (kurzer Anschnitt) auf Anfrage / * mit 5 Spannlöchern

Columns 1-4 → gel, for lapped threads 20% extra charge
○ in stock, price on request
Prices for further versions on request
70° (short chamfer) on request / * with 5 chipholes



Präzisions-Schneideisen
DIN EN 22568
Metrisches ISO-Feingewinde DIN 13

Precision thread cutting dies
DIN EN 22568
ISO metric fine thread DIN 13

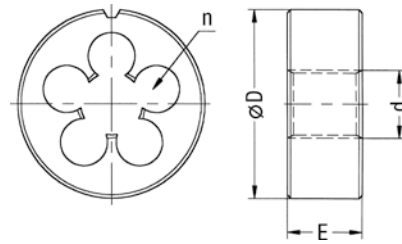

ORDER-CODE → RU →				1		2		3		4		5		6	
d	P mm	Ø D x E mm	n	HSS 6g		HSS 6g Schäl. spiral entry		HSS 6e Schäl. spiral entry		HSS 6g links Schäl. left hand spiral entry		HSS 6g Messing geläppt, Schäl. brass lapped, spiral entry		HSSE 6g Schäl., geläppt, nitr. spiral entry, lapped, nitrided	
↓	↓			x = 1,75 · P		x = 1,75 · P		x = 1,75 · P		x = 1,75 · P		x = 1,25 · P		x = 2 · P	
				Art.-Nr. €		Art.-Nr. €		Art.-Nr. €		Art.-Nr. €		Art.-Nr. €		Art.-Nr. €	
M 18	1,5	45 x 14	5	101779	33,20	104997	36,50	101788	50,60	104998	47,10	101781	52,30	104211	48,40
M 20	1,5	45 x 14	6	101970	33,20	105036	36,50	101976	58,40	105037	47,10	101972	58,60	104268	48,40
M 21	1,5	45 x 14	6			105046	68,90					101999	○		
M 22	1,5	55 x 16	5	102029	43,70	105059	47,90	102041	67,00	105060	71,30	102032	64,00		
M 22	1,5	55 x 16	6											104275	68,20
M 23	1,5	55 x 16	6			105069	○								
M 24	1,5	55 x 16	6	102090	43,70	105081	47,90	102094	84,20	105082	61,90	102092	74,40	104286	68,20
M 25	1,5	55 x 16	6	102115	51,80	105095	57,00	102120	○	105096	83,20			104291	○
M 26	1,5	55 x 16	6	102139	51,80	105101	57,00	102143	95,70	105102	123,00	102140	○	104297	98,30
M 27	1,5	65 x 18	6	102161	64,50	105112	71,00	102167	○	105113	115,00	102163	○	104301	○
M 28	1,5	65 x 18	6	102186	64,50	105121	71,00	102191	○	105122	144,00	102189	○	104305	○
M 30	1,5	65 x 18	6	102328	64,50	105158	71,00	102334	○	105159	91,90	102329	○	104349	105,00
M 32	1,5	65 x 18	7	102357	65,70	105173	72,40	102362	○	105174	143,00	102358	○	104356	○
M 33	1,5	65 x 18	7	102379	68,10	105183	74,90	108300	○	105184	○	102380	○	104358	○
M 34	1,5	65 x 18	7	102394	85,60	105191	94,20					102395	○	104360	○
M 35	1,5	65 x 18	8	102407	67,50	105198	74,10	102410	○	105199	134,00	102408	○	104362	○
M 36	1,5	65 x 18	8	102423	67,50	105209	74,10	102428	○	105210	134,00	102424	○	104367	○
M 38	1,5	75 x 20	7	102447	102,00	105223	112,00	106948	○	105224	185,00	102448	○	104369	○
M 39	1,5	75 x 20	7	102460	119,00	105230	131,00			108615	○			104371	○
M 40	1,5	75 x 20	8	102574	102,00	105251	112,00	102577	○	105252	185,00	102576	○	104407	○
M 42	1,5	75 x 20	8	102595	102,00	105259	112,00			105260	○	102596	○	104410	○
M 45	1,5	90 x 22	7	102611	137,00	105273	151,00			105274	○	102613	○	108528	○
M 48	1,5	90 x 22	8	102632	137,00	105284	151,00			105285	○	102633	○	104417	○
M 50	1,5	90 x 22	8	102734	137,00	105312	151,00			105313	○	108338	○		
M 52	1,5	90 x 22	9	102742	137,00	105323	151,00			141040	○	102743	○		
M 55	1,5	105 x 22	8	102753	186,00	105331	205,00								
M 56	1,5	105 x 22	8			105337	233,00			141042	○				
M 58	1,5	105 x 22	8			105343	217,00					106156	○		
M 60	1,5	105 x 22	9	102865	184,00	105369	203,00			141045	○				

Spalte 1-4 → gel, für geläppt Ausführung 20% Zuschlag
○ am Lager, Preis auf Anfrage
Preise für weitere Ausführungen auf Anfrage

Columns 1-4 → gel, for lapped threads 20% extra charge
○ in stock, price on request
Prices for further versions on request



Präzisions-Schneideisen DIN EN 22568 Metrisches ISO-Feingewinde DIN 13

Precision thread cutting dies
DIN EN 22568
ISO metric fine thread DIN 13

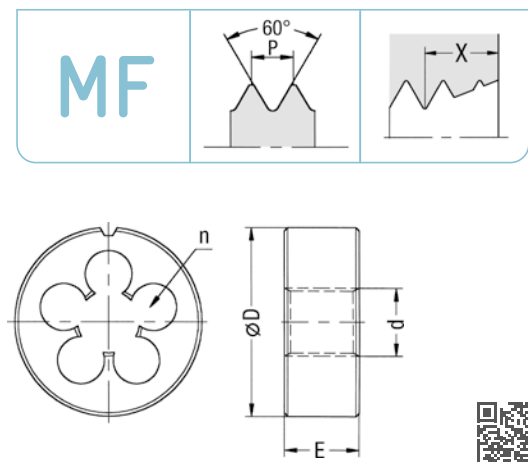

ORDER-CODE → RU →				1		2		3		4		5		6	
d	P mm	Ø D x E mm	n	HSS 6g		HSS 6g Schäl. spiral entry		HSS 6e Schäl. spiral entry		HSS 6g links Schäl. left hand spiral entry		HSS 6g Messing geläpft, Schäl. brass lapped, spiral entry		HSSE 6g Schäl., geläpft, nitr. spiral entry, lapped, nitrided	
↓	↓			x = 1,75 · P		x = 1,75 · P		x = 1,75 · P		x = 1,75 · P		x = 1,25 · P		x = 2 · P	
				Art.-Nr.	€	Art.-Nr.	€	Art.-Nr.	€	Art.-Nr.	€	Art.-Nr.	€	Art.-Nr.	€
M 62	1,5	105 x 22	9	108363	234,00	105376	258,00					108739	○		
M 64	1,5	105 x 22	10	102873	254,00	108642	279,00					141049	○		
M 65	1,5	105 x 22	10	102878	197,00	105383	217,00					102879	○		
M 70	1,5	120 x 22	9	102945	245,00	105408	269,00					108369	○		
M 75	1,5	120 x 22	11	102954	263,00	105415	290,00								
M 80	1,5	130 x 25	11			105441	361,00								
M 85	1,5	130 x 25	12			106153	○								
M 15	2	38 x 14	5			104964	94,80								
M 18	2	45 x 14	5	101795	41,40	105002	45,50			105003	○	141053	○	104215	○
M 20	2	45 x 14	6	101985	38,00	105039	41,80			105040	78,30	101986	○	104270	○
M 22	2	55 x 16	5	102049	52,40	105062	57,80			105063	○			104280	○
M 24	2	55 x 16	6	102098	48,40	105084	53,20			105085	80,80	141054	○	104288	98,30
M 25	2	55 x 16	6	102127	76,30	105097	83,90			108602	○	141055	○		
M 26	2	55 x 16	6			105104	91,90								
M 27	2	65 x 18	6	102170	71,10	105114	78,20			105115	○			104302	○
M 28	2	65 x 18	6	102197	93,60	105124	103,00			141044	○				
M 30	2	65 x 18	6	102339	71,10	105161	78,20			105162	101,00	102340	○	104353	130,00
M 32	2	65 x 18	7	102368	93,60	105176	103,00							106158	○
M 33	2	65 x 18	7	102386	71,10	105185	78,20							104359	○
M 35	2	65 x 18	8	102414	104,00	105200	114,00			105201	○				
M 36	2	65 x 18	8	102432	71,10	105211	78,20			105212	○	102433	○	104368	○
M 38	2	75 x 20	7			105225	137,00								
M 39	2	75 x 20	7	102464	114,00	105231	125,00								
M 40	2	75 x 20	7	102580	114,00	105253	125,00			108624	○				
M 42	2	75 x 20	8	102600	114,00	105261	125,00			105262	○				
M 45	2	90 x 22	7	102617	151,00	105275	166,00			106169	○				
M 48	2	90 x 22	8	102636	147,00	105286	162,00								
M 50	2	90 x 22	8	102738	156,00	105314	172,00			105315	○				
M 52	2	90 x 22	9	102746	147,00	105324	162,00								

Spalte 1-4 → gel, für geläppte Ausführung 20% Zuschlag

○ am Lager, Preis auf Anfrage

Preise für weitere Ausführungen auf Anfrage

Columns 1-4 → gel, for lapped threads 20% extra charge

○ in stock, price on request

Prices for further versions on request



Präzisions-Schneideisen DIN EN 22568 Metrisches ISO-Feingewinde DIN 13

Precision thread cutting dies
DIN EN 22568
ISO metric fine thread DIN 13

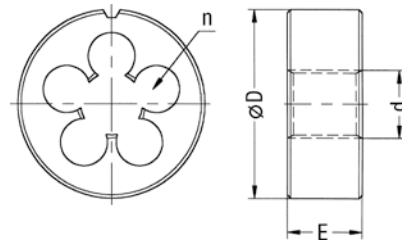

ORDER-CODE → RU →				1		2		3		4		5		6	
d	P mm	Ø D x E mm	n	HSS 6g		HSS 6g Schäl. spiral entry		HSS 6e Schäl. spiral entry		HSS 6g links Schäl. left hand spiral entry		HSS 6g Messing geläppt, Schäl. brass lapped, spiral entry		HSSE 6g Schäl., geläppt, nitr. spiral entry, lapped, nitrided	
				x = 1,75 · P		x = 1,75 · P		x = 1,75 · P		x = 1,75 · P		x = 1,25 · P		x = 2 · P	
↓	↓														
Art.-Nr.	€	Art.-Nr.	€	Art.-Nr.	€	Art.-Nr.	€	Art.-Nr.	€	Art.-Nr.	€	Art.-Nr.	€	Art.-Nr.	€
M 55	2	105 x 22	8	102756	186,00	105332	205,00								
M 56	2	105 x 22	8	102760	186,00	105338	205,00								
M 60	2	105 x 22	9	102866	180,00	105370	198,00								
M 64	2	105 x 22	10	102876	206,00	105379	227,00								
M 65	2	105 x 22	10	102880	194,00	105384	213,00			141099	○	102881	○		
M 70	2	120 x 22	9	102946	238,00	105409	261,00					108370	○		
M 72	2	120 x 22	10			105413	271,00								
M 75	2	120 x 22	10	102955	246,00	105416	271,00								
M 80	2	130 x 25	10	103086	287,00	105443	315,00					103087	○		
M 85	2	130 x 25	12	103092	333,00	105447	366,00								
M 90	2	140 x 25	11	103139	○	105467	○			141101	○				
M 95	2	150 x 25	11	103144	○	106159	○								
M 100	2	150 x 25	8	101408	○	104895	○								
M 30	3	65 x 25	6	102348	121,00	105164	133,00								
M 33	3	65 x 25	7			105188	157,00								
M 36	3	65 x 25	7	102437	90,50	105214	99,50			105215	○			106735	○
M 39	3	75 x 20	7	102468	123,00	105233	135,00			108616	○			107085	○
M 42	3	75 x 20	8	102601	123,00	105264	135,00			108628	○				
M 45	3	90 x 22	7	102620	165,00	105276	181,00			141102	○				
M 48	3	90 x 22	7	102637	165,00	105287	181,00								
M 52	3	90 x 22	8			105326	217,00			105327	○				
M 56	3	105 x 22	8			105339	○								
M 60	3	105 x 22	8			105373	○								
M 56	4	105 x 22	8			105340	○								
M 64	4	105 x 22	9			105381	○								

Spalte 1-4 → gel, für geläppt Ausführung 20% Zuschlag
○ am Lager, Preis auf Anfrage
Preise für weitere Ausführungen auf Anfrage

Columns 1-4 → gel, for lapped threads 20% extra charge
○ in stock, price on request
Prices for further versions on request



Präzisions-Schneideisen mit Aufschraublöchern

Metrisches ISO-Feingewinde DIN 13

Ausführung: Anschnitt beidseitig, geläppt,
mit Schälanschnitt ab M 3 beidseitig

**Precision thread cutting dies
with two fixing holes**

ISO metric fine thread DIN 13

Specification: chamfered on both sides, lapped,
with spiral entry for M 3 and above on both sides

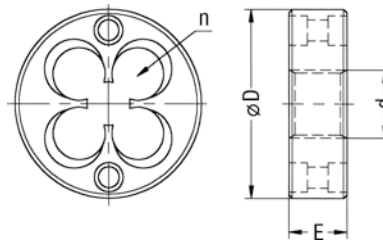
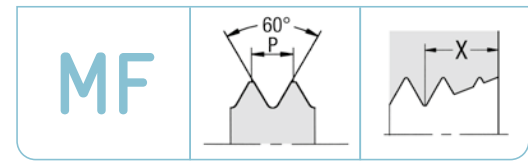

ORDER-CODE → ASL →				6e		MS	
d	P mm	Ø D x E mm	n	HSS 6g	HSS 6e	HSS 6g Messing brass	
↓	↓			x = 1,75 · P 	x = 1,75 · P 	x = 1,25 · P 	
				Art.-Nr.	€	Art.-Nr.	€
M 2	0,25	16 x 2	4	100178	○		
M 3	0,35	16 x 3	4	100234	38,60		
M 4	0,35	16 x 3,5	4	100264	○		
M 4	0,5	16 x 4	4	100268	29,10		100270 ○
M 5	0,5	20 x 5	4	100293	31,50		
M 6	0,5	20 x 5	4	100320	34,80		100321 ○
M 7	0,5	25 x 7	4	100333	○		
M 8	0,5	25 x 7	6	100344	○		
M 6	0,75	20 x 7	4	100323	23,90		100325 ○
M 7	0,75	25 x 7	4	100334	43,40		
M 8	0,75	25 x 7	4	100346	37,30		
M 10	0,75	30 x 7	6	100086	○		○
M 8	1	25 x 7	4	100352	27,40	100356 ○	100354 ○
M 10-25	1	25 x 7	6	100093	63,90		
M 10	1	30 x 7	6	100092	39,60	100098 ○	100094 ○
M 12	1	30 x 7	6	100119	42,70	100123 ○	
M 14	1	35 x 10	6	100144	○		
M 10	1,25	25 x 9	6	100101	49,40		
M 12	1,25	30 x 11	6	100126	50,60		
M 12	1,5	30 x 11	6	100129	51,20	100131 ○	
M 14	1,5	35 x 10	6	100148	56,90	100149 ○	
M 16	1,5	45 x 14	6	100157	72,70		

○ am Lager, Preis auf Anfrage

Preise für weitere Gewinde und Ausführungen auf Anfrage

○ in stock, price on request

Prices for further threads and versions on request

Sechskantschneideisen DIN 382 Metrisches ISO-Feingewinde DIN 13

Hexagon die nuts
DIN 382
ISO metric fine thread DIN 13

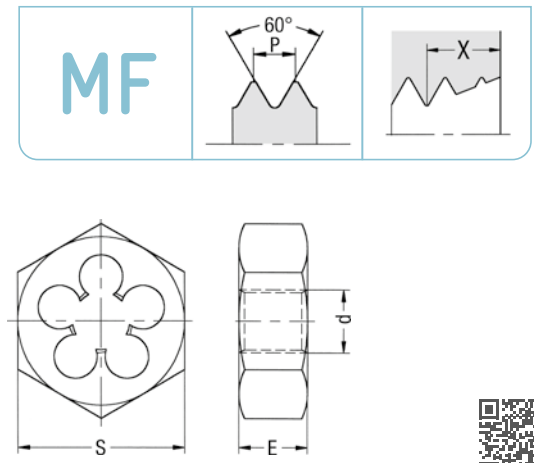

ORDER-CODE → SK →			Schäl			
d	P mm	S x E mm	HSS 6g		HSS 6g Schäl. spiral entry	
↓	↓		x = 1,65 · P		x = 1,65 · P	
			Art.-Nr.	€	Art.-Nr.	€
M 8	1	21 x 9	120493	○	121012	○
M 10	1	27 x 11	120088	○	120918	○
M 12	1	36 x 10	120113	○	120923	○
M 14	1	36 x 10	120131	○	120928	○
M 16	1	41 x 14	120158	○	120934	○
M 10	1,25	27 x 11	120090	○	120919	○
M 12	1,25	36 x 10	120114	○	120924	○
M 14	1,25	36 x 10	120133	○	120929	○
M 12	1,5	36 x 10	120116	37,40	120925	○
M 14	1,5	36 x 10	120135	33,60	120930	○
M 16	1,5	41 x 14	120161	38,60	120936	○
M 18	1,5	41 x 14	120176	38,60	120940	○
M 20	1,5	41 x 14	120197	38,60	120944	○
M 22	1,5	50 x 16	120210	60,70	120948	○
M 24	1,5	50 x 16	120224	53,10	120950	○
M 25	1,5	50 x 16	120231	○	121148	○
M 27	1,5	60 x 18	120248	○	120954	○
M 30	1,5	60 x 18	120270	84,20	120962	○
M 33	1,5	60 x 18	120286	○	120966	○
M 36	1,5	60 x 18	120301	104,00	120970	○
M 38	1,5	70 x 20	120308	○	120972	○
M 39	1,5	70 x 20	120315	○	120974	○
M 40	1,5	70 x 20	120327	129,00	120977	○
M 42	1,5	70 x 20	120337	○	120979	○
M 45	1,5	85 x 22	120349	159,00	121149	○
M 48	1,5	85 x 22	120362	159,00	120985	○
M 52	1,5	85 x 22	120389	○	120992	○
M 55	1,5	100 x 22	120399	○	121150	○

○ am Lager, Preis auf Anfrage
Preise für weitere Gewinde auf Anfrage

○ in stock, price on request
Prices for further threads on request

Sechskantschneideisen DIN 382 Metrisches ISO-Feingewinde DIN 13

Hexagon die nuts
DIN 382
ISO metric fine thread DIN 13

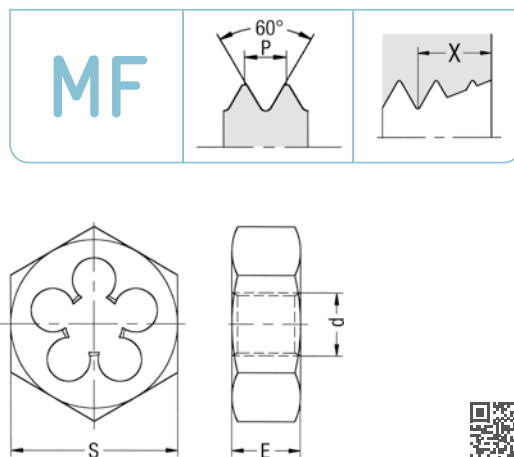

ORDER-CODE → SK →			HSS 6g		Schäl	
d	P mm	S x E mm	HSS 6g		HSS 6g	
↓	↓		Schäl.		spiral entry	
			x = 1,65 · P		x = 1,65 · P	
M			Art.-Nr.	€	Art.-Nr.	€
M 60	1,5	100 x 22	120428	○	120999	○
M 65	1,5	115 x 22	120444	○	121002	○
M 18	2	41 x 14	120180	○	120942	○
M 20	2	41 x 14	120200	○	120946	○
M 22	2	50 x 16	120213	○	121151	○
M 24	2	50 x 16	120226	72,70	120951	○
M 27	2	60 x 18	120250	111,00	120955	○
M 30	2	60 x 18	120272	93,10	120963	○
M 33	2	60 x 18	120288	114,00	120967	○
M 36	2	60 x 18	120303	93,10	120971	○
M 42	2	70 x 20	120339	129,00	120980	○
M 48	2	85 x 22	120364	○	121152	○
M 52	2	85 x 22	120391	○	121153	○
M 55	2	100 x 22	120401	○	121154	○
M 56	2	100 x 22	120407	214,00	120994	○
M 60	2	100 x 22	120430	214,00	121000	○
M 64	2	115 x 22	120440	252,00	121155	○
M 65	2	115 x 22	120446	252,00	121003	○
M 70	2	115 x 22	120463	258,00	121005	○
M 72	2	115 x 22	120468	○	121006	○
M 75	2	115 x 22	120477	269,00	121007	○
M 80	2	130 x 25	120497	○	121013	○
M 85	2	130 x 25	120507	○	121014	○
M 90	2	140 x 25	120521	○	121017	○
M 36	3	60 x 25	120305	○	121156	○
M 42	3	70 x 20	120341	136,00	120981	○
M 48	3	85 x 22	120367	177,00	120986	○
M 56	4	100 x 22	120411	○	121157	○
M 60	4	100 x 22	120433	○	121158	○
M 64	4	115 x 22	120442	○	121159	○

○ am Lager, Preis auf Anfrage
Preise für weitere Gewinde auf Anfrage

○ in stock, price on request
Prices for further threads on request



Präzisions-Schneideisen
 ≈ DIN EN 22568

Metrisches kegeliges Außengewinde
 DIN 158

Kegel 1:16
 Ausführung: mit Schälanschnitt

Precision thread cutting dies
 ≈ DIN EN 22568

Metric external taper thread DIN 158
 Taper 1:16
 Specification: with spiral entry

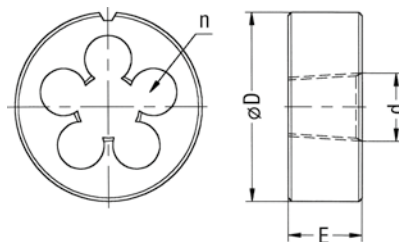

M keg.
 M taper

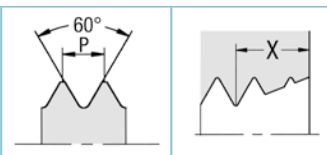

ORDER-CODE → RU keg →					
d	P mm	Ø D x E mm	n	HSS	
↓	↓				
				$x = 1,75 \cdot P$	
				Art.-Nr.	€
M 6	1	20 x 7	4	103164	52,30
M 8	1	25 x 9	4	103168	58,70
M 10	1	30 x 11	5	103146	58,70
M 12	1,5	38 x 14	5	103151	○
M 14	1,5	38 x 14	5	103152	○
M 16	1,5	45 x 14	5	103154	○
M 18	1,5	45 x 14	5	103156	○

○ am Lager, Preis auf Anfrage

➔ gel, für geläppte Ausführung 20% Zuschlag

○ in stock, price on request

➔ gel, for lapped threads 20% extra charge



Präzisions-Glockenschneideisen Whitworth-Rohrgewinde DIN EN ISO 228

Ausführung: mit Schälanschnitt

Precision bell form thread cutting dies

Whitworth pipe thread

DIN EN ISO 228

Specification: with spiral entry

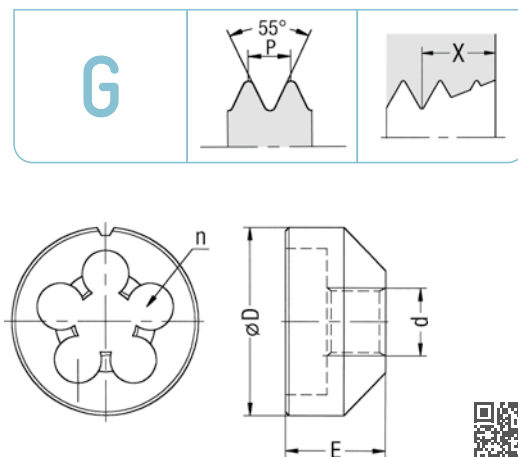

ORDER-CODE → GL →					MS		- 0,1 MS		HM		Ecobrass ²			
d	P Gg/1" tpi	Ø d mm	Ø D x E mm	n	HSS Tol. A geläppt lapped	HSS Tol. A Messing geläppt brass lapped	HSS Tol. A 0,1 mm Untermaß, Messing geläppt 0.1 mm undersize brass lapped	Hartmetall, Tol. A für MS und Rg, Gewinde geschliffen carbide, for brass and gun metal, thread grinded	HSSE Tol. A Ecobrass, geläppt für bleifreies Messing Ecobrass, lapped for unleaded brass					
↓					x = 1,75 · P 	x = 1,25 · P 	x = 1,25 · P 	x = 1,5 · P 	x = 1,5 · P 					
Art.-Nr.	€	Art.-Nr.	€	Art.-Nr.	€	Art.-Nr.	€	Art.-Nr.	€	Art.-Nr.	€			
G 1/8"	28	9,73	25 x 14	5	100559	○	108095	○			181686	Preis auf Anfrage		
G 1/4"	19	13,16	30 x 18	6	100554	○	100555	67,70	100557	○	181687			
G 3/8"	19	16,66	38 x 20	6	100568	○	100570	82,90	100572	○	108814		691,00 ¹	181064
G 1/2"	14	20,96	45 x 24	6	100546	○	100547	87,50	100550	○	108131	729,00 ¹	180157	price on request
G 3/4"	14	26,44	55 x 28	6	100561	○	100562	116,00	100566	○	108132	784,00 ¹	140090	
G 1"	11	33,25	65 x 30	7	108093	○	100539	163,00	100540	○	108130	840,00* ¹	181024	

○ am Lager, Preis auf Anfrage

Maße für Bolzenvorbereitung siehe Seite 159

*mit 6 Spanlöchern

¹aus Vollhartmetall, alternativ mit eingelöteten Hartmetall-Schneidstegen

²beschichtete Ausführung auf Anfrage

○ in stock, price on request

For blank preparation see page 159

*with 6 chip holes

¹solid carbide, alternative carbide-tipped (brazed)

²coated version on request

DLC-Beschichtung zur Bearbeitung von Ecobrass

- höhere Produktivität
- besserer Spanfluss
- optimierte Gleitfähigkeit bewirkt ein verringertes Drehmoment
- Schutz gegen Adhäsion
- hohe Härte und thermische Stabilität

DLC coating for processing Ecobrass

- higher productivity
- better chip flow
- optimised lubricity results in reduced torque
- protection against adhesion
- high hardness and thermal stability



M
MF
MJ
EG M

G
Rc, R
Pg

UNC
UNF
UN
UNJF

NPT
NPTF



M
MF
M keg.
M taper

G
BSW
BSF
DIN 477
R, BA, Pg

UNC
UNF
UNEF
UN, UNS

NPSM
NPT
NPTF
Tr, Rd



M
MF

G
BSW
BSF
R, Pg
MF-EL



UNC, UNF
UNEF
UN, UNS
UNJC
UNJF

NPT
NPTF
Tr
EG

Präzisions-Schneideisen
DIN EN 24231
Whitworth-Rohrgewinde
DIN EN ISO 228

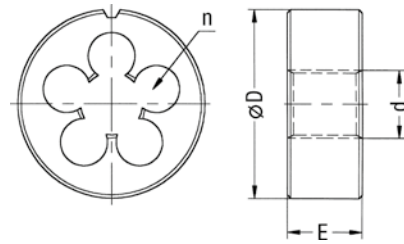
Precision thread cutting dies
DIN EN 24231
Whitworth pipe thread
DIN EN ISO 228



ORDER-CODE → RU →					Schäl		LH	
d	P Gg/1" tpi	Ø d mm	Ø D x E mm	n	HSS Tol. A x = 1,75 · P 	HSS Tol. A Schäl. spiral entry x = 1,75 · P 	HSS links Tol. A Schäl. left hand spiral entry x = 1,75 · P 	
↓					Art.-Nr.	€	Art.-Nr.	€
G 1/16"	28	7,72	25 x 9	4	100976	○	104849	51,20
G 1/8"	28	9,73	30 x 11	5	101044	23,40	104855	25,80
G 1/4"	19	13,16	38 x 10	5	101012	23,40	104853	25,80
G 3/8"	19	16,66	45 x 14	5	101120	31,30	104868	34,30
G 1/2"	14	20,96	45 x 14	6	100977	31,30	104850	34,30
G 5/8"	14	22,91	55 x 16	5	101157	47,80	104871	52,50
G 3/4"	14	26,44	55 x 16	6	101080	47,40	104866	52,10
G 7/8"	14	30,20	65 x 18	6	101166	74,80	104873	82,30
G 1"	11	33,25	65 x 18	7	100920	66,00	104837	72,60
G 1 1/8"	11	37,90	75 x 20	7	100965	118,00	104842	130,00
G 1 1/4"	11	41,91	75 x 20	8	100950	97,70	104840	108,00
G 1 3/8"	11	44,32	90 x 22	7	100972	182,00	104845	200,00
G 1 1/2"	11	47,80	90 x 22	8	100937	135,00	104839	148,00
G 1 3/4"	11	53,75	90 x 22	9	100970	144,00	104843	158,00
G 2"	11	59,61	105 x 22	9	101064	174,00	104859	192,00
G 2 1/4"	11	65,71	105 x 22	10	101074	220,00	104862	242,00
G 2 1/2"	11	75,18	120 x 22	10	101071	236,00	104861	259,00
G 2 3/4"	11	81,53	120 x 22	12	101076	289,00	104863	318,00
G 3"	11	87,88	130 x 25	8	101079	307,00	104865	338,00
G 3 1/2"	11	100,33	150 x 25	8	106161	○	141087	○
G 4"	11	113,03	160 x 25	9	101155	○	106097	○

→ gel, für geläppte Ausführung 20% Zuschlag
○ am Lager, Preis auf Anfrage

→ gel, for lapped threads 20% extra charge
○ in stock, price on request

Maße für Bolzenschneideisen siehe Seite 159

For blank preparation see page 159



Präzisions-Schneideisen
DIN EN 24231
Whitworth-Rohrgewinde
DIN EN ISO 228

Precision thread cutting dies
DIN EN 24231
Whitworth pipe thread
DIN EN ISO 228

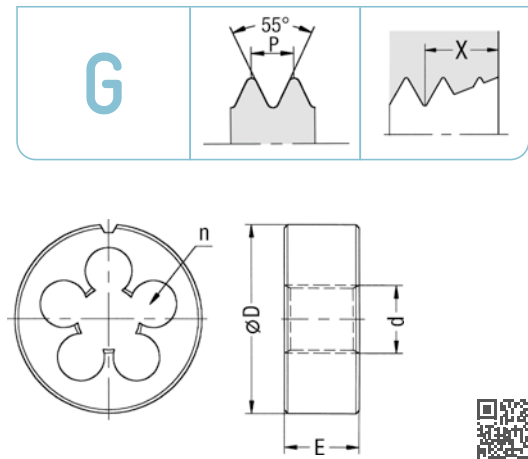

ORDER-CODE → RU →					MS	- 0,1 MS		VA	Ecobrass			
d	P Gg/1" tpi	Ø d mm	Ø D x E mm	n	HSS Tol. A Messing geläppt, Schäl. brass lapped, spiral entry x = 1,75 · P	HSS Tol. A 0,1 mm Untermaß, Messing geläppt, Schäl. 0.1 mm undersize brass lapped, spiral entry x = 1,25 · P		HSSE Tol. A Schäl., geläppt, nitr. spiral entry, lapped, nitrided x = 2 · P	HSSE Tol. A Ecobrass, für bleifreies Messing, geläppt, Schäl. Ecobrass, for unleaded brass, lapped, spiral entry x = 1,5 · P			
↓					Art.-Nr.	€	Art.-Nr.	€	Art.-Nr.	€	Art.-Nr.	€
G 1/16"	28	7,72	25 x 9	4					103982	○		
G 1/8"	28	9,73	30 x 11	5	101047	35,00	101058	59,20	103995	33,20	142634	
G 1/4"	19	13,16	38 x 10	5	101016	35,00	101030	48,40	103989	33,80	144602	
G 3/8"	19	16,66	45 x 14	5	101123	44,30	101139	51,40	104010	47,40	144419	
G 1/2"	14	20,96	45 x 14	6	100978	44,30	100995	49,70	103983	44,30	144418	
G 5/8"	14	22,91	55 x 16	5	101158	○	101162	○	104013	○*	145145	Preis auf Anfrage
G 3/4"	14	26,44	55 x 16	6	101082	67,00	101097	79,70	104003	67,40	141486	
G 7/8"	14	30,20	65 x 18	6	101167	○	101170	○	104014	○	145147	price on request
G 1"	11	33,25	65 x 18	7	100921	92,50	100929	104,00	103972	92,90**	107438	
G 1 1/8"	11	37,90	75 x 20	7	100966	○					145148	
G 1 1/4"	11	41,91	75 x 20	8	100951	137,00	100956	145,00	103977	146,00***	145149	
G 1 3/8"	11	44,32	90 x 22	7								
G 1 1/2"	11	47,80	90 x 22	8	100938	188,00	100943	○	103975	202,00	144603	
G 1 3/4"	11	53,75	90 x 22	9	100971	○						
G 2"	11	59,61	105 x 22	9	101066	○	108807	○	103999	○****		
G 2 1/4"	11	65,71	105 x 22	10	101075	○						
G 2 1/2"	11	75,18	120 x 22	10	101072	○						
G 2 3/4"	11	81,53	120 x 22	12								

○ am Lager, Preis auf Anfrage

Preise für weitere Ausführungen auf Anfrage

Maße für Bolzengewinde siehe Seite 159

- * mit 6 Spanlöchern
- ** mit 8 Spanlöchern
- *** mit 9 Spanlöchern
- **** mit 11 Spanlöchern

○ in stock, price on request

Prices for further versions on request

For blank preparation see page 159

- * with 6 chip holes
- ** with 8 chip holes
- *** with 9 chip holes
- **** with 11 chip holes



Sechskantschneideisen DIN 382 Whitworth-Rohrgewinde DIN EN ISO 228

Hexagon die nuts
DIN 382
Whitworth pipe thread
DIN EN ISO 228

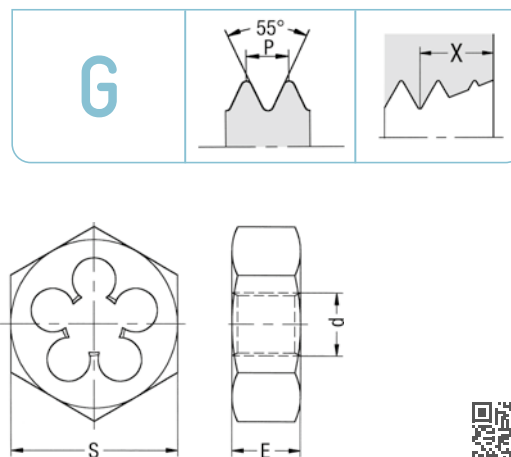

ORDER-CODE → SK →			Schäl		LH			
d	P Gg/1" tpi	S x E mm	HSS Tol. A	HSS Tol. A Schäl. spiral entry	HSS links Tol. A left hand			
			$x = 1,65 \cdot P$	$x = 1,65 \cdot P$	$x = 1,65 \cdot P$			
			Art.-Nr.	€	Art.-Nr.	€	Art.-Nr.	€
G 1/8"	28	27 x 11	120014	23,70	120903	○	120015	○
G 1/4"	19	36 x 10	120012	26,70	120901	○	120013	○
G 3/8"	19	41 x 14	120067	35,10	120912	○	120068	○
G 1/2"	14	41 x 14	120010	35,10	120900	○	120011	○
G 5/8"	14	50 x 16	120071	○	120913	○		
G 3/4"	14	50 x 16	120025	61,90	120911	○	120066	○
G 7/8"	14	60 x 18	120074	○	120914	○		
G 1"	11	60 x 18	120058	76,00	120896	○	120060	○
G 1 1/8"	11	70 x 20	120002	○	121163	○		
G 1 1/4"	11	70 x 20	120063	105,00	120898	○		
G 1 3/8"	11	85 x 22	120006	203,00	121141	○		
G 1 1/2"	11	85 x 22	120061	142,00	120897	○		
G 1 3/4"	11	100 x 22	120004	○	120899	○		
G 2"	11	100 x 22	120016	179,00	120905	○		
G 2 1/4"	11	115 x 22	120019	○	120907	○		
G 2 1/2"	11	115 x 22	120018	252,00	120906	○		
G 2 3/4"	11	115 x 22	120021	○	120908	○		
G 3"	11	130 x 25	120023	○	120909	○		
G 3 1/2"	11	150 x 25	121162	○	120910	○		
G 4"	11	160 x 25	120069	○	121164	○		

○ am Lager, Preis auf Anfrage
Preise für größere Gewinde auf Anfrage





○ in stock, price on request
Prices for larger threads on request

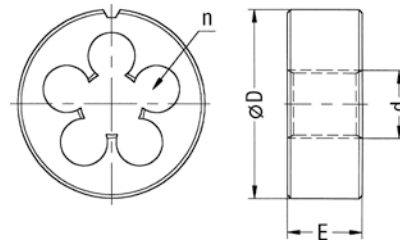
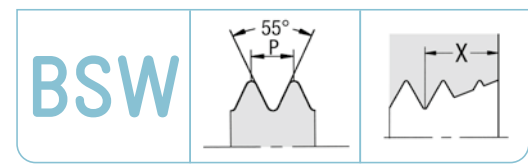

Präzisions-Schneideisen
DIN EN 22568
Whitworth-Gewinde BS 84

Precision thread cutting dies
DIN EN 22568
British Standard Whitworth thread BS 84



ORDER-CODE → RU →					Schäl		LH		VA			
d	P Gg/1" tpi	Ø d mm	Ø D x E mm	n	HSS Tol. med. x = 1,75 · P 	HSS Tol. med. Schäl. spiral entry x = 1,75 · P 	HSS links Tol. med. Schäl. left hand spiral entry x = 1,75 · P 	HSSE Tol. med Schäl, geläppt, nitr. spiral entry, lapped, nitrided x = 2 · P 				
					Art.-Nr.	€	Art.-Nr.	€	Art.-Nr.	€	Art.-Nr.	€
BSW 1/16"	60	1,59	16 x 5	3	103802	43,20						
BSW 3/32"	48	2,38	16 x 5	3	103880	35,40						
BSW 1/8"	40	3,18	20 x 5	4			105780	22,40	105781	○	104749	○
BSW 5/32"	32	3,97	20 x 7	4			105828	22,80				
BSW 3/16"	24	4,76	20 x 7	4			105806	22,30	141103	○	104751	○
BSW 7/32"	24	5,56	20 x 7	4			105841	22,30				
BSW 1/4"	20	6,35	20 x 7	4			105775	19,00	105776	○	104747	○*
BSW 5/16"	18	7,94	25 x 9	4			105824	24,00	105825	○	104755	○*
BSW 3/8"	16	9,53	30 x 11	4			105813	24,80	105814	○	104754	○*
BSW 7/16"	14	11,11	30 x 11	4			105836	26,10	105837	○	104761	○*
BSW 1/2"	12	12,70	38 x 14	4			105769	31,70	105770	○	104746	○*
BSW 9/16"	12	14,29	38 x 14	4			105851	41,40			104764	○*
BSW 5/8"	11	15,88	45 x 18	4			105831	40,90	105832	○	104759	○*
BSW 3/4"	10	19,05	45 x 18	5			105808	43,30	105809	○	104753	○*
BSW 7/8"	9	22,23	55 x 22	5			105842	59,20			104763	○**
BSW 1"	8	25,40	55 x 22	5			105752	59,20	105753	○	104741	○**
BSW 1 1/8"	7	28,58	65 x 25	5			105762	125,00				
BSW 1 1/4"	7	31,75	65 x 25	6			105760	101,00				
BSW 1 3/8"	6	34,93	65 x 25	6			105765	134,00				
BSW 1 1/2"	6	38,10	75 x 30	6			105758	168,00				
BSW 1 5/8"	5	41,28	75 x 30	7			105767	○				
BSW 1 3/4"	5	44,45	90 x 36	6			108681	328,00				
BSW 2"	4 1/2	50,80	90 x 36	7			105793	278,00				
BSW 2 1/4"	4	57,15	105 x 36	7			105795	○				
BSW 2 1/2"	4	63,50	105 x 36	8			105794	○				
BSW 2 3/4"	3 1/2	69,85	120 x 36	8			141083	○				
BSW 3"	3 1/2	76,20	120 x 36	9			141084	○				

→ gel, für geläppte Ausführung 20% Zuschlag
○ am Lager, Preis auf Anfrage

* mit 5 Spanlöchern
** mit 6 Spanlöchern

→ gel, for lapped threads 20% extra charge
○ in stock, price on request

* with 5 chip holes
** with 6 chip holes



M
MF
MJ
EG M

6
Rc, R
Pg

UNC
UNF
UN
UNJF

NPT
NPTF



M
MF
M keg.
M taper

6
BSW
BSF
DIN 477
R, BA, Pg

UNC
UNF
UNEF
UN, UNS

NPSM
NPT
NPTF
Tr, Rd



M
MF

6
BSW
BSF
R, Pg
MF-EL

UNC, UNF
UNEF
UN, UNS
UNJC
UNJF

NPT
NPTF
Tr
EG

Sechskantschneideisen DIN 382 Whitworth-Gewinde BS 84

Hexagon die nuts
DIN 382
British Standard Whitworth thread BS 84

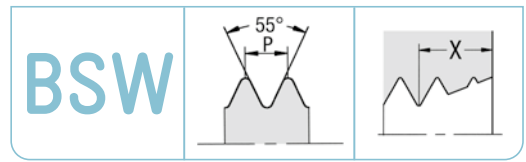
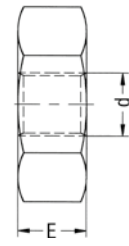
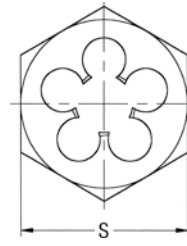

ORDER-CODE → SK →			
d	P Gg/1" tpi	S x E mm	HSS Tol. med.
			$x = 1,65 \cdot P$
			Art.-Nr. €
BSW 1/8"	40	18 x 5	120829 ○
BSW 3/16"	24	18 x 7	120857 ○
BSW 1/4"	20	18 x 7	120827 ○
BSW 5/16"	18	21 x 9	120876 ○
BSW 3/8"	16	27 x 11	120864 ○
BSW 7/16"	14	27 x 11	120882 ○
BSW 1/2"	12	36 x 14	120824 ○
BSW 5/8"	11	41 x 18	120879 ○
BSW 3/4"	10	41 x 18	120860 55,00
BSW 7/8"	9	50 x 22	120885 ○
BSW 1"	8	50 x 22	120806 70,80
BSW 1 1/8"	7	60 x 25	120813 ○
BSW 1 1/4"	7	60 x 25	120811 ○
BSW 1 3/8"	6	60 x 25	120820 ○
BSW 1 1/2"	6	70 x 30	120810 ○
BSW 1 3/4"	5	85 x 36	120818 ○
BSW 2"	4 1/2	85 x 36	120836 ○

○ am Lager, Preis auf Anfrage

○ in stock, price on request



Präzisions-Schneideisen
DIN EN 22568
Whitworth-Feingewinde BS 84
Ausführung: mit Schälanschnitt

Precision thread cutting dies
DIN EN 22568
British Standard Whitworth fine thread BS 84
Specification: with spiral entry

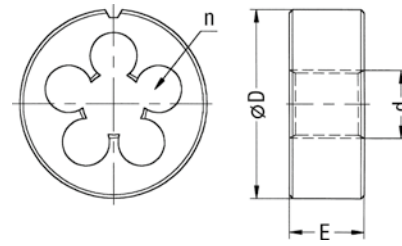
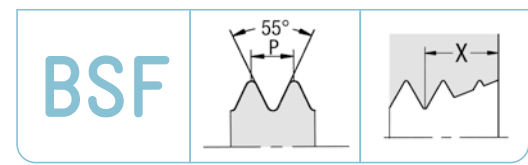

ORDER-CODE → RU →						
d	P Gg/1" tpi	Ø d mm	Ø D x E mm	n	HSS Tol. med.	
↓					x = 1,75 · P	
						
					Art.-Nr.	€
BSF 3/16"	32	4,76	20 x 7	4	105605	29,10
BSF 1/4"	26	6,35	20 x 7	4	105601	26,30
BSF 5/16"	22	7,94	25 x 9	4	105610	27,90
BSF 3/8"	20	9,53	30 x 11	4	105608	27,20
BSF 7/16"	18	11,11	30 x 11	4	105614	32,90
BSF 1/2"	16	12,70	38 x 10	4	105599	40,60
BSF 9/16"	16	14,29	38 x 10	5	105617	53,00
BSF 5/8"	14	15,88	45 x 14	5	105612	55,00
BSF 3/4"	12	19,05	45 x 14	5	105606	55,00
BSF 7/8"	11	22,23	55 x 16	5	105616	80,40
BSF 1"	10	25,40	55 x 16	6	105592	80,40
BSF 1 1/8"	9	28,58	65 x 18	6	105596	○
BSF 1 1/4"	9	31,75	65 x 18	6	105595	○
BSF 1 3/8"	8	34,93	65 x 18	7	105597	○
BSF 1 1/2"	8	38,10	75 x 20	7	105594	○

→ gel, für geläppte Ausführung 20% Zuschlag
○ am Lager, Preis auf Anfrage

→ gel, for lapped threads 20% extra charge
○ in stock, price on request



Präzisions-Schneideisen Gewinde an Gasflaschenventilen Kegeliges Whitworth-Gewinde DIN 477, DIN EN ISO 11363-1, DIN EN 144-1, DIN EN 629-1, DIN EN ISO 11116-1

Kegel 3:25
Ausführung: mit Schälanschnitt

Precision thread cutting dies
Threads on gas cylinder valves
Whitworth taper thread DIN 477, DIN EN ISO 11363-1,
DIN EN 144-1, DIN EN 629-1 and DIN EN ISO 11116-1
Taper 3:25
Specification: with spiral entry

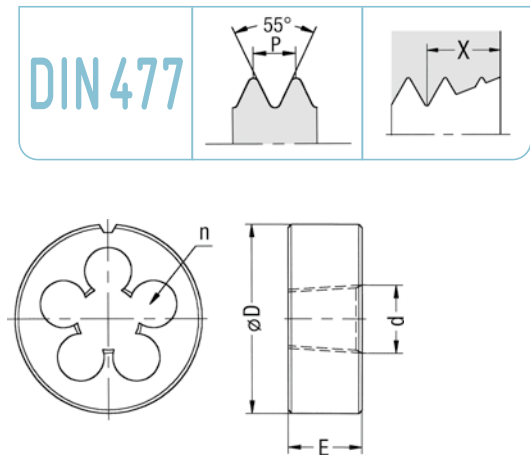

ORDER-CODE → RU				MS	
d	P Gg/1" tpi	Ø D x E mm	n	kegelig HSS tapered	kegelig HSS Messing, geläppt tapered brass, lapped
↓	↓			$x = 1,75 \cdot P$ 	$x = 1,25 \cdot P$
				Art.-Nr. €	Art.-Nr. €
W 19,8 (17E)	14	45 x 25	5	103944 153,00	103945 154,00
W 28,8 (25E)	14	65 x 30	5	108500 219,00	103946 220,00
W 31,3	14	65 x 30	6	141082 ○	103947 ○

Präzisions-Schneideisen Gewinde an Gasflaschenventilen Zylindrisches Whitworth-Gewinde DIN 477

Ausführung: mit Schälanschnitt

Precision thread cutting dies
Threads on gas cylinder valves
Whitworth parallel thread DIN 477
Specification: with spiral entry

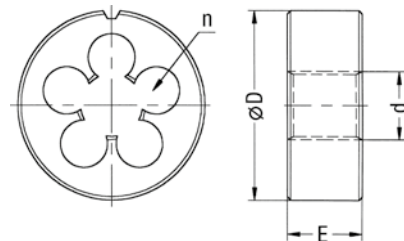

ORDER-CODE → RU				MS		LH		LH-MS	
d	P Gg/1" tpi	Ø D x E mm	n	zylindrisch HSS parallel	zylindrisch HSS Messing, geläppt parallel brass, lapped	zylindrisch, links HSS parallel, left hand	zylindrisch, links HSS Messing geläppt parallel, left hand brass, lapped		
↓	↓			$x = 1,75 \cdot P$ 	$x = 1,25 \cdot P$ 	$x = 1,75 \cdot P$ 	$x = 1,25 \cdot P$ 		
				Art.-Nr. €	Art.-Nr. €	Art.-Nr. €	Art.-Nr. €		
W 21,8	14	55 x 16	5	103859 91,60	103860 105,00	103861 104,00	103862 116,00		
W 24,32	14	55 x 16	6	103865 142,00	103866 ○				

→ gel, für geläppte Ausführung 20% Zuschlag
○ am Lager, Preis auf Anfrage

→ gel, for lapped threads 20% extra charge
○ in stock, price on request



Präzisions-Schneideisen
 ≈ DIN EN 24230

Kegeliges Whitworth-Rohrgewinde
 DIN EN 10226, ISO 7-1, DIN 2999,
 DIN 3858, BS 21

Kegel 1:16
 Für im Gewinde dichtende Verbindungen

Precision thread cutting dies
 ≈ DIN EN 24230

Tapered Whitworth pipe thread
 DIN EN 10226, ISO 7-1, DIN 2999, DIN 3858, BS 21
 Taper 1:16, for thread sealing connections

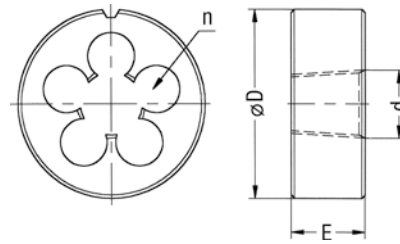
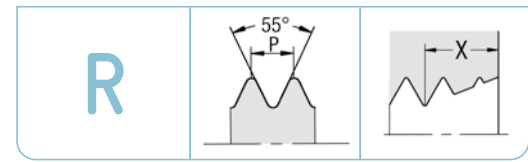

ORDER-CODE → RU				1		2		3		4		5	
d	P Gg/1" tpi	Ø D x E mm	n	HSS		Schäl		MS		VA		GL HM	
				x = 1,75 · P		x = 1,75 · P		x = 1,25 · P		x = 2 · P		x = 1,5 · P	
↓													
				Art.-Nr.	€	Art.-Nr.	€	Art.-Nr.	€	Art.-Nr.	€	Art.-Nr.	€
R 1/8"	28	30 x 11	5	103455	35,50	105585	37,30	103457	○	104662	○		
R 1/4"	19	38 x 14	5	103450	36,50	105584	38,30	103451	○	104661	○		
R 3/8"	19	45 x 14	5	103465	47,70	105589	50,10	103466	○	104665	○		
R 1/2"	14	45 x 18	6	103447	47,70	105582	50,10	103448	○	104660	○	108136	861,00 Ø 45 x 24
R 3/4"	14	55 x 22	6	103461	78,90	105588	82,80	103462	○	104663	○	108137	993,00 Ø 55 x 28
R 1"	11	65 x 25	7	103441	101,00	105577	106,00			104656	○	100789	1152,00 Ø 65 x 30
R 1 1/4"	11	75 x 26	8	103446	173,00	105579	182,00						
R 1 1/2"	11	90 x 27	8	103445	208,00	105578	218,00						
R 2"	11	105 x 28	9	103459	269,00	105586	283,00						
R 2 1/2"	11	120 x 36	10	103460	○	108657	○						

Spalte 1 und 2 → gel, für geläppte Ausführung 20% Zuschlag
 Spalte 5 Glockenform
 ○ am Lager, Preis auf Anfrage

Maße für Bolzenvorbereitung siehe Seite 159

Columns 1 and 2 → gel, for lapped threads 20% extra charge
 Column 5 bell form
 ○ in stock, price on request

For blank preparation see page 159

Präzisions-Schneideisen
 ≈ DIN 40434 und DIN EN 22568
Stahlpanzerrohr-Gewinde DIN 40430
 Ausführung: mit Schälanschnitt

Precision thread cutting dies
 ≈ DIN 40434 and DIN EN 22568
 Steel conduit thread DIN 40430
 Specification: with spiral entry

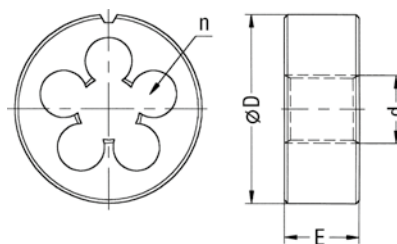
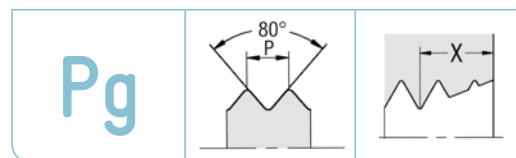

ORDER-CODE → RU →						
d	P Gg/1" tpi	Ø d mm	Ø D x E mm	n	HSS	
↓						$x = 1,75 \cdot P$ 
					Art.-Nr.	€
Pg 7	20	12,50	38 x 10	5	105556	39,40
Pg 9	18	15,20	38 x 10	5	105557	39,40
Pg 11	18	18,60	45 x 14	5	105548	50,90
Pg 13,5	18	20,40	45 x 14	6	105549	50,90
Pg 16	18	22,50	55 x 16	5	105550	68,10
Pg 21	16	28,30	65 x 18	6	105551	90,20
Pg 29	16	37,00	65 x 18	8	105552	98,20
Pg 36	16	47,00	90 x 22	8	105553	186,00
Pg 42	16	54,00	90 x 22	10	105554	○
Pg 48	16	59,30	105 x 22	9	105555	○

→ gel, für geläppte Ausführung 20% Zuschlag

○ am Lager, Preis auf Anfrage

Das Stahlpanzerrohr-Gewinde DIN 40430 soll durch das Gewinde für Elektroinstallationsrohre DIN EN 60423 ersetzt werden.

Dabei handelt es sich um 12 Metrische Feingewinde von M 6x0,75 bis M 75x1,5.

Wir empfehlen dafür Metrische ISO-Feingewinde Schneideisen der Toleranz 6g.

→ gel, for lapped threads 20% extra charge

○ in stock, price on request

The steel conduit thread DIN 40430 is to be replaced by the electrical conduit thread DIN EN 60423.





These are 12 metric fine threads form M 6x0.75 to M 75x1.5. We therefore recommend metric ISO-fine thread cutting dies in tolerance class 6g.

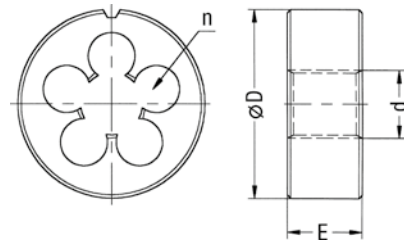
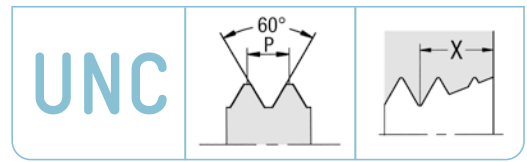

Präzisions-Schneideisen DIN EN 22568 UNC-Grobgewinde ASME B1.1

Precision thread cutting dies
DIN EN 22568
Unified national coarse thread ASME B1.1



ORDER-CODE → RU →					1	2	3	4	5					
d	P Gg/1" tpi	Ø d mm	Ø D x E mm	n	HSS Tol. 2A x = 1,75 · P 	HSS Tol. 2A Schäl. spiral entry x = 1,75 · P 	HSS Tol. 2A links Schäl. left hand spiral entry x = 1,75 · P 	HSS Tol. 3A Schäl. ab Nr. 5 spiral entry No. 5 and above x = 1,75 · P 	HSSE Tol. 2A Schäl., geläppt, nitr. ab Nr. 5 spiral entry, lapped, nitrided No. 5 and above x = 2 · P 					
					Art.-Nr.	€	Art.-Nr.	€	Art.-Nr.	€	Art.-Nr.	€		
UNC Nr. 1	64	1,85	16 x 5	3	103171	36,30								
UNC Nr. 2	56	2,18	16 x 5	4	103183	30,60					104565	○		
UNC Nr. 3	48	2,52	16 x 5	4	103185	36,20								
UNC Nr. 4	40	2,85	16 x 5	4	103187	25,90			103196	○	104568	42,10		
UNC Nr. 5	40	3,18	20 x 5	4	103200	20,30	105474	22,40	141095	○	104570	○		
UNC Nr. 6	32	3,51	20 x 7	4	103202	18,80	105476	20,70	103206	○	104572	36,60		
UNC Nr. 8	32	4,17	20 x 7	4	103210	17,20	105478	19,00	103213	○	104576	36,60		
UNC Nr. 10	24	4,83	20 x 7	4	103174	18,70	105468	20,60	105469	○	104563	○		
UNC Nr. 12	24	5,49	20 x 7	4	103177	20,30	105470	22,30			104564	○		
UNC 1/4"	20	6,35	20 x 7	4	103229	15,20	105491	16,80	105492	○	103233	○	104583	32,90*
UNC 5/16"	18	7,94	25 x 9	4	103247	17,30	105499	19,10	105500	○	103250	○	104588	46,50*
UNC 3/8"	16	9,53	30 x 11	4	103240	20,40	105497	22,40	105498	○	103244	○	104586	48,80*
UNC 7/16"	14	11,11	30 x 11	4	103255	21,10	105504	23,10	105505	○	103258	○	104590	○*
UNC 1/2"	13	12,70	38 x 14	4	103226	25,70	105488	28,20	105489	○	103227	○	104581	○*
UNC 9/16"	12	14,29	38 x 14	4	103262	29,00	105509	31,90	105510	○			104592	○*
UNC 5/8"	11	15,88	45 x 18	4	103252	33,90	105502	37,30	105503	○			104589	○*
UNC 3/4"	10	19,05	45 x 18	5	103237	37,90	105495	41,70	105496	○			104585	○
UNC 7/8"	9	22,23	55 x 22	5	103260	50,90	105506	56,10	105507	○			104591	○**
UNC 1"	8	25,40	55 x 22	5	103216	50,90	105480	56,10	105481	○			104577	○**
UNC 1 1/8"	7	28,58	65 x 25	5	103223	95,40	105484	105,00						
UNC 1 1/4"	7	31,75	65 x 25	6	103221	95,40	105483	105,00	141108	○				
UNC 1 3/8"	6	34,93	65 x 25	6			105487	115,00						
UNC 1 1/2"	6	38,10	75 x 30	6	103219	132,00	105482	145,00						
UNC 1 3/4"	5	44,45	90 x 36	6			105485	253,00						
UNC 2"	4 1/2	50,80	90 x 36	7			105494	253,00						

Spalte 1 und 2 → gel, für geläppt Ausführung 20% Zuschlag

○ am Lager, Preis auf Anfrage

Preise für weitere Ausführungen auf Anfrage

Maße für Bolzenvorbereitung siehe Seite 160

* mit 5 Spanlöchern

** mit 6 Spanlöchern

Columns 1 and 2 → gel, for lapped threads 20% extra charge

○ in stock, price on request

Prices for further versions on request

For blank preparation see page 160

* with 5 chip holes

** with 6 chip holes

Sechskantschneideisen DIN 382 UNC-Grobgewinde ASME B1.1

Hexagon die nuts
DIN 382
Unified national coarse thread ASME B1.1

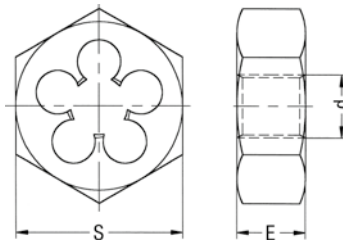
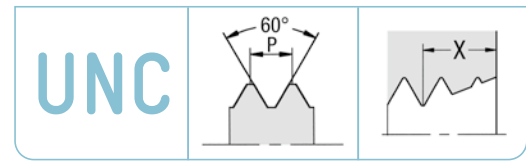

ORDER-CODE → SK →				
d	P Gg/1" tpi	S x E mm	HSS Tol. 2A	
↓			$x = 1,65 \cdot P$ 	
			Art.-Nr.	€
UNC Nr. 10	24	18 x 7	120526	○
UNC Nr. 12	24	18 x 7	120527	○
UNC 1/4"	20	18 x 7	120544	23,20
UNC 5/16"	18	21 x 9	120553	24,90
UNC 3/8"	16	27 x 11	120552	28,00
UNC 7/16"	14	27 x 11	120557	○
UNC 1/2"	13	36 x 14	120542	33,70
UNC 9/16"	12	36 x 14	120560	41,10
UNC 5/8"	11	41 x 18	120555	43,70
UNC 3/4"	10	41 x 18	120550	43,70
UNC 7/8"	9	50 x 22	120558	74,60
UNC 1"	8	50 x 22	120534	82,40
UNC 1 1/8"	7	60 x 25	120539	149,00
UNC 1 1/4"	7	60 x 25	120537	121,00
UNC 1 3/8"	6	60 x 25	120541	○
UNC 1 1/2"	6	70 x 30	120536	○
UNC 1 3/4"	5	85 x 36	120540	○
UNC 2"	4 1/2	85 x 36	120547	○

○ am Lager, Preis auf Anfrage
UNEf-, UN- und UNS-Gewinde, Preise auf Anfrage

○ in stock, price on request
Prices for UNEf-, UN- and UNS-threads on request

Präzisions-Schneideisen
DIN EN 22568
UNF-Feingewinde ASME B1.1

Precision thread cutting dies
DIN EN 22568
Unified national fine thread ASME B1.1

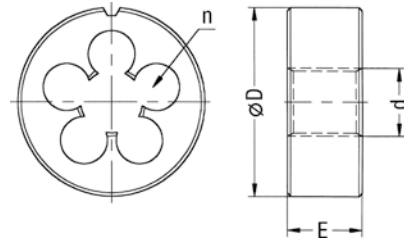
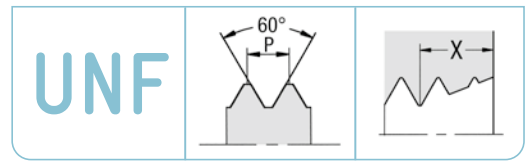

ORDER-CODE → RU					1	2	3	4	5					
d	P Gg/1" tpi	Ø d mm	Ø D x E mm	n	HSS Tol. 2A x = 1,75 · P 	Schäl. 2 HSS Tol. 2A Schäl. spiral entry x = 1,75 · P 	LH 3 HSS Tol. 2A links Schäl. left hand spiral entry x = 1,75 · P 	3A 4 HSS Tol. 3A Schäl. ab Nr. 5 spiral entry No. 5 and above x = 1,75 · P 	VA 5 HSSE Tol. 2A Schäl., geläppt, nitr. ab Nr. 5 spiral entry, lapped, nitrided No. 5 and above x = 2 · P 					
					Art.-Nr.	€	Art.-Nr.	€	Art.-Nr.	€	Art.-Nr.	€	Art.-Nr.	€
UNF Nr. 0	80	1,52	16 x 5	3	103266	26,70								
UNF Nr. 1	72	1,85	16 x 5	3	103268	25,70								
UNF Nr. 2	64	2,18	16 x 5	4	103279	35,70								
UNF Nr. 3	56	2,52	16 x 5	4	103282	34,10								
UNF Nr. 4	48	2,85	16 x 5	4	103284	33,50					103287	○	104603	○
UNF Nr. 5	44	3,18	20 x 5	4	103289	26,00	105519	28,60			103290	○	104605	○
UNF Nr. 6	40	3,51	20 x 5	4	103293	24,00	105521	26,40			103296	○	104607	○
UNF Nr. 8	36	4,17	20 x 7	4	103297	20,00	105522	22,10			108406	○	104609	○
UNF Nr. 10	32	4,83	20 x 7	4	103269	15,70	105512	17,20	105513	○	103272	○	104595	30,30
UNF Nr. 12	28	5,49	20 x 7	4	103276	19,70	105514	21,70			108742	○	104600	○
UNF 1/4"	28	6,35	20 x 7	4	103317	15,20	105531	16,80	105532	32,90	103320	○	104618	36,40
UNF 5/16"	24	7,94	25 x 9	4	103342	17,30	105538	19,10	105539	44,40	103348	○	104628	37,80
UNF 3/8"	24	9,53	30 x 11	4	103332	20,40	105535	22,40	105536	37,30	103336	○	104624	46,60*
UNF 7/16"	20	11,11	30 x 11	5	103359	21,20	105542	23,10	105543	61,90	103366	○	104634	46,20
UNF 1/2"	20	12,70	38 x 10	5	103310	25,70	105529	28,20	105530	51,60	103313	○	104614	76,00
UNF 9/16"	18	14,29	38 x 10	5	103375	28,90	105545	31,80	105546	47,50	103377	○	104639	○
UNF 5/8"	18	15,88	45 x 14	5	103351	33,90	105540	37,30	105541	67,40	103357	○	104631	○
UNF 3/4"	16	19,05	45 x 14	6	103325	33,90	105533	37,30	105534	69,30	103330	○	104621	○
UNF 7/8"	14	22,23	55 x 16	5	103370	46,50	105544	51,10	108656	84,70	103373	○	104636	○
UNF 1"	12	25,40	55 x 16	6	103299	48,80	105523	53,60	105524	○				
UNF 1 1/8"	12	28,58	65 x 18	6	103308	77,70	105527	85,40						
UNF 1 1/4"	12	31,75	65 x 18	7	103306	77,70	105526	85,40	108652	○				
UNF 1 3/8"	12	34,93	65 x 18	8	103309	89,60	105528	98,50						
UNF 1 1/2"	12	38,10	75 x 20	7	103302	110,00	105525	121,00						

Spalte 1-4 → gel, für geläppt Ausführung 20% Zuschlag

○ am Lager, Preis auf Anfrage

Preise für weitere Ausführungen auf Anfrage

Maße für Bolzenvorbereitung siehe Seite 160

* mit 5 Spanlöchern

Columns 1-4 → gel, for lapped threads 20% extra charge

○ in stock, price on request

Prices for further versions on request

For blank preparation see page 160

* with 5 chip holes



Sechskantschneideisen DIN 382 UNF-Feingewinde ASME B1.1

Hexagon die nuts
DIN 382
Unified national fine thread ASME B1.1

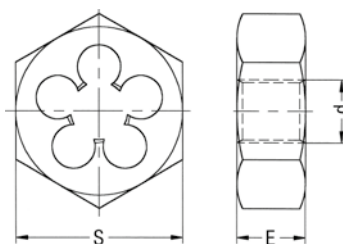
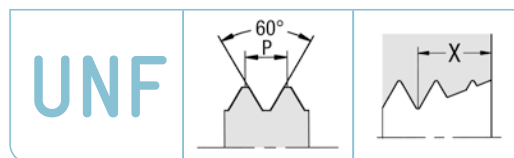

ORDER-CODE → SK →				
d	P Gg/1" tpi	S x E mm	HSS Tol. 2A	
↓			x = 1,65 · P 	
			Art.-Nr.	€
UNF Nr. 10	32	18 x 7	120563	○
UNF Nr. 12	28	18 x 7		
UNF 1/4"	28	18 x 7	120580	23,20
UNF 5/16"	24	21 x 9	120586	24,90
UNF 3/8"	24	27 x 11	120584	28,00
UNF 7/16"	20	27 x 11	120590	45,70
UNF 1/2"	20	36 x 10	120578	32,70
UNF 9/16"	18	36 x 10	120594	37,10
UNF 5/8"	18	41 x 14	120588	42,10
UNF 3/4"	16	41 x 14	120582	42,10
UNF 7/8"	14	50 x 16	120592	○
UNF 1"	12	50 x 16	120571	○
UNF 1 1/8"	12	60 x 18	120576	○
UNF 1 1/4"	12	60 x 18	120574	○
UNF 1 3/8"	12	60 x 18	120577	○
UNF 1 1/2"	12	70 x 20	120573	○

○ am Lager, Preis auf Anfrage
UNEF-, UN- und UNS-Gewinde, Preise auf Anfrage

○ in stock, price on request
Prices for UNEF-, UN- and UNS threads on request

- M
MF
MJ
EG M
- 6
Rc, R
Pg
- UNC
UNF
UN
UNJF
- NPT
NPTF
- M
MF
M keg.
M taper
- 6
BSW
BSF
DIN 477
R, BA, Pg
- UNC
UNF
UN, UNS
- NPSM
NPT
NPTF
Tr, Rd
- M
MF
- 6
BSW
BSF
R, Pg
MF-EL
- UNC, UNF
UN, UNS
UNJC
UNJF
- NPT
NPTF
Tr
EG

Präzisions-Schneideisen
 ≙ DIN EN 22568
 UNEF-Extra Feingewinde ASME B1.1

Precision thread cutting dies
 ≙ DIN EN 22568
 Unified national extra fine thread ASME B1.1

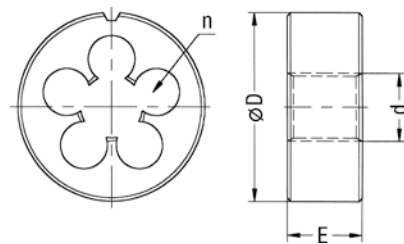
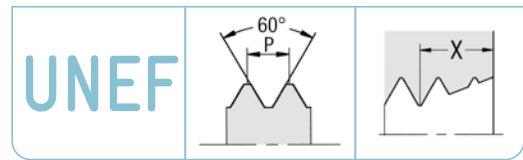

ORDER-CODE → RU →					Schäl	
d	P Gg/1" tpi	Ø d mm	Ø D x E mm	n	HSS Tol. 2A Schäl. spiral entry	
↓					x = 1,75 · P 	
					Art.-Nr.	€
UNEF Nr. 12	32	5,49	20 x 7	4	104811	48,00
UNEF 1/4"	32	6,35	20 x 7	4	104821	32,40
UNEF 5/16"	32	7,94	25 x 9	4	104829	27,90
UNEF 3/8"	32	9,53	30 x 11	4	104828	29,00
UNEF 7/16"	28	11,11	30 x 11	5	104832	36,40
UNEF 1/2"	28	12,70	38 x 10	5	104820	39,60
UNEF 9/16"	24	14,29	38 x 10	5	104834	39,20
UNEF 5/8"	24	15,88	45 x 14	5	104830	49,80
UNEF 11/16"	24	17,46	45 x 14	5	104823	78,70
UNEF 3/4"	20	19,05	45 x 14	6	104826	47,70
UNEF 13/16"	20	20,64	45 x 14	6	104824	80,30
UNEF 7/8"	20	22,23	55 x 16	5	104833	75,10
UNEF 15/16"	20	23,81	55 x 16	6	104825	125,00
UNEF 1"	20	25,40	55 x 16	6	104812	85,00
UNEF 1 1/16"	18	26,99	65 x 18	6	104816	○
UNEF 1 1/8"	18	28,58	65 x 18	6	104815	121,00
UNEF 1 3/16"	18	30,16	65 x 18	6	108559	○
UNEF 1 1/4"	18	31,75	65 x 18	7	104814	○
UNEF 1 5/16"	18	33,34	65 x 18	7	104818	○
UNEF 1 3/8"	18	34,93	65 x 18	8	104817	○
UNEF 1 7/16"	18	36,51	75 x 20	7	106165	○
UNEF 1 1/2"	18	38,10	75 x 20	7	104813	○

→ gel, für geläppte Ausführung 20% Zuschlag
 ○ am Lager, Preis auf Anfrage

→ gel, for lapped threads 20% extra charge
 ○ in stock, price on request





Präzisions-Schneideisen
 ≙ DIN EN 22568
 UN-Gewinde, UNS-Spezialgewinde
 ASME B1.1

Ausführung: mit Schälanschnitt

Precision thread cutting dies
 ≙ DIN EN 22568

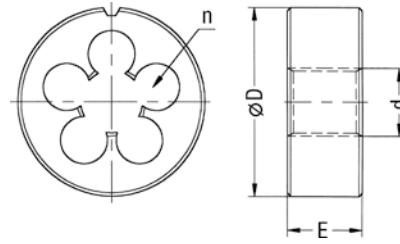
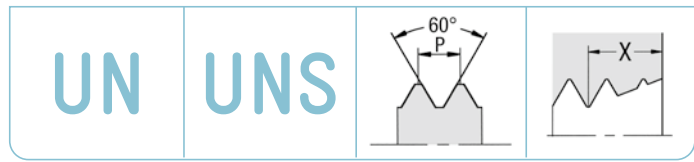
Unified national thread, Unified national special thread ASME B1.1
 Specification: with spiral entry



ORDER-CODE → RU →					HSS Tol. 2A	
d	P Gg/1" tpi	Ø d mm	Ø D x E mm	n	x = 1,75 · P	
↓	↓					
					Art.-Nr.	€
UNS 1/4"	40	6,35	20 x 5	4	103687	48,00
UNS 1/4"	36	6,35	20 x 5	4	103682	30,10
UNS 1/4"	24	6,35	20 x 7	4	103681	50,50
UNS 7/16"	24	11,11	30 x 11	5	103750	37,80
UNS 1/2"	24	12,70	38 x 10	5	105689	54,60
UN 9/16"	20	14,29	38 x 10	5	105749	90,00
UN 11/16"	20	17,46	45 x 14	5	105699	68,10
UN 11/16"	16	17,46	45 x 14	5	105697	57,70
UNS 1"	14	25,40	55 x 16	6	105647	68,90
UN 1 1/16"	12	26,99	65 x 18	5	105664	92,80
UN 1 3/16"	12	30,16	65 x 18	6	105675	148,00
UN 1 5/16"	12	33,34	65 x 18	7	105682	117,00
UN 1 5/8"	12	41,28	75 x 20	8	105679	135,00
UN 1 3/4"	12	44,45	90 x 22	7	105668	168,00
UN 2"	12	50,80	90 x 22	8	105712	225,00
UN 1 1/8"	8	28,58	65 x 25	5	105663	116,00
UN 1 1/4"	8	31,75	65 x 25	6	105660	116,00
UN 1 3/8"	8	34,93	65 x 25	7	105674	133,00
UN 1 1/2"	8	38,10	75 x 20	7	105656	128,00
UN 1 5/8"	8	41,28	75 x 20	7	105681	○
UN 1 3/4"	8	44,45	90 x 22	7	105671	174,00
UN 2"	8	50,80	90 x 22	8	105713	174,00
UN 2 1/4"	8	57,15	105 x 22	8	105717	○
UN 2 1/2"	8	63,50	105 x 22	9	105715	○

→ gel, für geläppte Ausführung 20% Zuschlag
 ○ am Lager, Preis auf Anfrage
 Preise für weitere Gewinde auf Anfrage

→ gel, for lapped threads 20% extra charge
 ○ in stock, price on request
 Prices for further threads on request





Präzisions-Schneideisen
 ≙ DIN EN 22568
 NPSM-Amerikanisches Rohrgewinde
 ASME B1.20.1

Ausführung: mit Schälanschnitt

Precision thread cutting dies
 ≙ DIN EN 22568

National straight pipe thread for mechanical joints ASME B1.20.1

Specification: with spiral entry

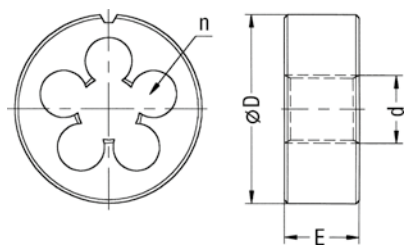
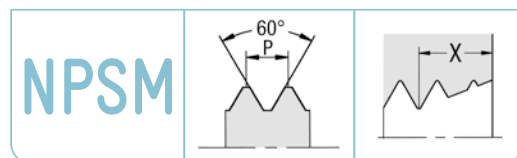

ORDER-CODE → RU →						
d	P Gg/1" tpi	Ø d mm	Ø D x E mm	n	HSS Tol. 2A	
↓					$x = 1,75 \cdot P$ 	
					Art.-Nr.	€
NPSM 1/8"	27	10,11	30 x 11	5	103517	62,60
NPSM 1/4"	18	13,39	38 x 10	5	103515	54,40
NPSM 3/8"	18	16,85	45 x 14	5	103523	72,10
NPSM 1/2"	14	20,94	45 x 14	6	103513	87,00
NPSM 3/4"	14	26,30	55 x 16	6	103521	128,00
NPSM 1"	11,5	32,88	65 x 18	7	103509	○
NPSM 1 1/4"	11,5	41,65	75 x 20	8	103512	○
NPSM 1 1/2"	11,5	47,72	90 x 22	8	103511	○
NPSM 2"	11,5	59,76	105 x 22	9	103520	○

→ gel, für geläppte Ausführung 20% Zuschlag
 ○ am Lager, Preis auf Anfrage

→ gel, for lapped threads 20% extra charge
 ○ in stock, price on request



Präzisions-Schneideisen NPT-Kegeliges Amerikanisches Rohrgewinde ASME B1.20.1

Kegel 1:16
Für Gewinde mit Dichtmittel

Precision thread cutting dies
American Standard taper pipe
thread ASME B1.20.1

Tapet 1:16
For threads used with jointing compound

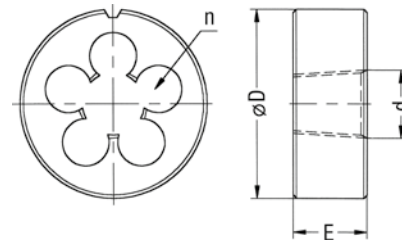
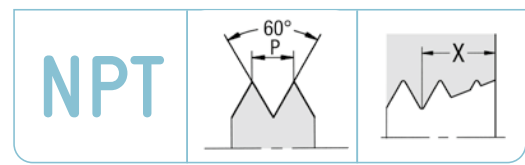

ORDER-CODE → RU →				1		2		3		4	
d	P Gg/1" tpi	Ø D x E mm	n	HSS	HSS Schäl. spiral entry	HSS Messing geläppt, Schäl. brass lapped, spiral entry	MS	VA	MS	VA	VA
				$x = 1,75 \cdot P$	$x = 1,75 \cdot P$	$x = 1,25 \cdot P$		$x = 2 \cdot P$			
↓											
				Art.-Nr.	€	Art.-Nr.	€	Art.-Nr.	€	Art.-Nr.	€
NPT 1/16"	27	25 x 9	4	103418	39,60	105563	41,60			108544	○
NPT 1/8"	27	30 x 11	5	103425	35,10	105567	36,90	103426	○	106119	72,90
NPT 1/4"	18	38 x 14	5	103422	38,70	105565	40,60	103423	○	104653	66,40
NPT 3/8"	18	45 x 14	5	103436	47,10	105573	49,60	103437	○	104655	87,80
NPT 1/2"	14	45 x 18	6	103419	47,10	105564	49,60	103420	○	104652	85,00
NPT 3/4"	14	55 x 22	6	103433	77,70	105572	81,70	103434	○	104654	119,00
NPT 1"	11,5	65 x 25	7	103413	99,50	105558	105,00			104649	○
NPT 1 1/4"	11,5	75 x 26	8	103417	140,00	105562	147,00				
NPT 1 1/2"	11,5	90 x 27	8	103416	194,00	105560	204,00				
NPT 2"	11,5	105 x 28	9	103429	251,00	105568	264,00				
NPT 2 1/2"	8	120 x 36	10	108426	○	105570	○				
NPT 3"	8	140 x 36	11	103432	○	105571	○				

Spalte 1 und 2 → gel, für geläppte Ausführung 20% Zuschlag
○ am Lager, Preis auf Anfrage

Maße für Bolzenvorbereitung siehe Seite 161

Columns 1 and 2 → gel, for lapped threads 20% extra charge
○ in stock, price on request

For blank preparation see page 161

- M
MF
MJ
EG M
- 6
Rc, R
Pg
- UNC
UNF
UN
UNJF
- NPT
NPTF
- M
MF
M keg.
M taper
- 6
BSW
BSF
DIN 477
R, BA, Pg
- UNC
UNF
UNEF
UN, UNS
- NPSM
NPT
NPTF
Tr, Rd
- M
MF
- 6
BSW
BSF
R, Pg
MF-EL
- UNC, UNF
UNEF
UN, UNS
UNJC
UNJF
- NPT
NPTF
Tr
EG

Sechskantschneideisen DIN 382 NPT-Kegeliges Amerikanisches Rohrgewinde ASME B1.20.1

Kegel 1:16
Für Gewinde mit Dichtmittel

Hexagon die nuts DIN 382

American Standard taper pipe
thread ASME B1.20.1
Taper 1:16
For threads used with jointing compound

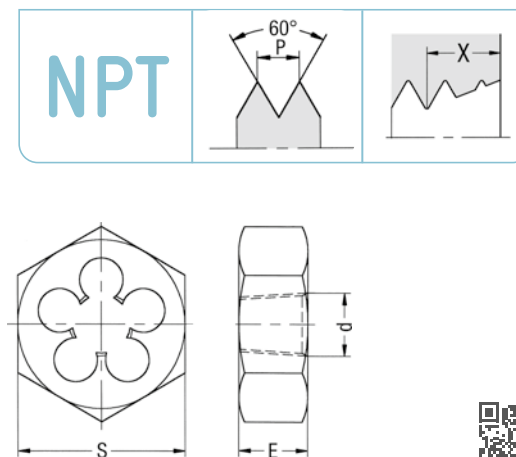

ORDER-CODE → SK →				
d	P Gg/1" tpi	Ø D x E mm	HSS	
			$x = 1,65 \cdot P$	
			Art.-Nr.	€
NPT 1/8"	27	27 x 11	120611	46,60
NPT 1/4"	18	36 x 14	120610	50,60
NPT 3/8"	18	41 x 14	120616	59,60
NPT 1/2"	14	41 x 18	120609	61,90
NPT 3/4"	14	60 x 18	120615	104,00
NPT 1"	11,5	60 x 25	120604	124,00
NPT 1 1/4"	11,5	70 x 30	120606	○
NPT 1 1/2"	11,5	85 x 27	120605	○
NPT 2"	11,5	100 x 28	120612	○

○ am Lager, Preis auf Anfrage

○ in stock, price on request



Präzisions-Schneideisen NPTF-Kegeliges Amerikanisches Rohrgewinde ANSI B1.20.3

Kegel 1:16
Für Gewinde ohne Dichtmittel

Precision thread cutting dies
American Standard taper pipe
thread ANSI B1.20.3
Taper 1:16
For threads used without jointing compound

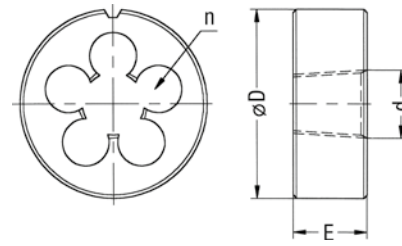
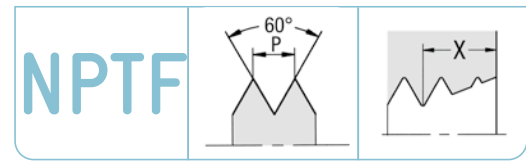

ORDER-CODE → RU →				Schäl			
d	P Gg/1" tpi	Ø D x E mm	n	HSS	HSS Schäl. spiral entry		
↓				$x = 1,75 \cdot P$	$x = 1,75 \cdot P$		
				Art.-Nr.	€	Art.-Nr.	€
NPTF 1/16"	27	25 x 9	4	103526	○	105622	73,80
NPTF 1/8"	27	30 x 11	5	103529	○	105626	43,80
NPTF 1/4"	18	38 x 14	5	103527	○	105624	50,70
NPTF 3/8"	18	45 x 14	5	103534	○	105629	65,60
NPTF 1/2"	14	45 x 18	6	108450	○	105623	77,10
NPTF 3/4"	14	55 x 22	6	103532	○	105628	107,00
NPTF 1"	11,5	65 x 25	7	103524	○	105618	158,00
NPTF 1 1/4"	11,5	75 x 26	8	103525	○	105621	○
NPTF 1 1/2"	11,5	90 x 27	8	108449	○	105620	○
NPTF 2"	11,5	105 x 28	9	103531	○	105627	○

→ gel, für geläppte Ausführung 20% Zuschlag
○ am Lager, Preis auf Anfrage

Maße für Bolzenvorbereitung siehe Seite 161

→ gel, for lapped threads 20% extra charge
○ in stock, price on request

For blank preparation see page 161

M
MF
MJ
EG M

6
Rc, R
Pg

UNC
UNF
UN
UNJF

NPT
NPTF

M
MF
M keg.
M taper

6
BSW
BSF
DIN 477
R, BA, Pg

UNC
UNF
UNEF
UN, UNS

NPSM
NPT
NPTF
Tr, Rd

M
MF

6
BSW
BSF
R, Pg
MF-EL

UNC, UNF
UNEF
UN, UNS
UNJC
UNJF

NPT
NPTF
Tr
EG

Präzisions-Schneideisen

≙ DIN EN 22568

Metrisches ISO-Trapez-Gewinde

DIN 103

Ausführung: mit Schälanschnitt

Precision thread cutting dies
 ≙ DIN EN 22568
 ISO metric trapezoidal thread
 DIN 103
 Specification: with spiral entry

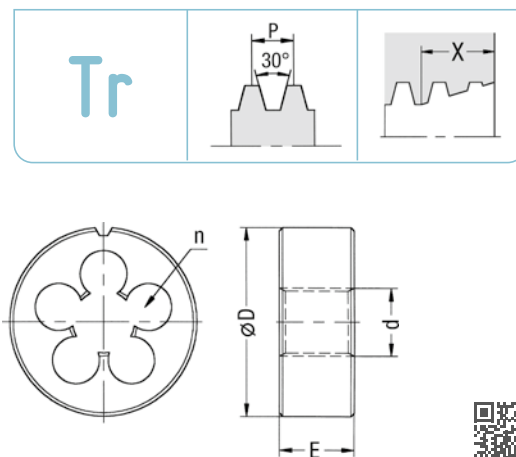

ORDER-CODE → RU →				LH			
d	P mm	Ø D x E mm	n	HSS 7e		HSS 7e links left hand	
↓	↓			x = 1,75 · P		x = 1,75 · P	
				Art.-Nr.	€	Art.-Nr.	€
Tr 8	1,5	25 x 9	4	103626	○		
Tr 9	1,5	30 x 11	4	103631	○		
Tr 9	2	30 x 11	4	103633	○		
Tr 10	1,5	30 x 11	4	108453	○		
Tr 10	2	38 x 14	4	103537	67,80	103538	84,90
Tr 10	3	38 x 14	4	103544	90,40	103546	○
Tr 11	2	38 x 14	4	103550	○		
Tr 11	3	38 x 14	4	103552	○		
Tr 12	2	38 x 14	4	103554	87,50	103556	○
Tr 12	3	38 x 14	4	103558	86,70	103560	135,00
Tr 14	2	38 x 14	4	103561	96,00	103562	○
Tr 14	3	45 x 18	4	103563	97,00	103564	○
Tr 14	4	45 x 18	4	103565	106,00	103566	196,00
Tr 16	2	45 x 18	4	103571	116,00	103572	○
Tr 16	4	45 x 18	4	103574	88,10	103575	137,00
Tr 18	2	45 x 18	5	103579	125,00		
Tr 18	4	45 x 18	5	103581	104,00	103582	171,00
Tr 20	2	45 x 18	6	103585	125,00	106074	○
Tr 20	4	55 x 22	5	103587	116,00	103588	160,00
Tr 22	5	55 x 22	5	103591	168,00	108457	○
Tr 24	3	55 x 22	5	103593	○		
Tr 24	5	65 x 25	5	103594	154,00	108458	219,00
Tr 26	5	65 x 25	5	103599	176,00	103600	○
Tr 28	5	65 x 25	5	103605	196,00	103606	○
Tr 30	3	65 x 25	6	103607	○	103608	○
Tr 30	6	65 x 25	5	103610	185,00	103611	○
Tr 32	6	65 x 25	6	103614	242,00	103615	○
Tr 36	6	65 x 25	6	103618	185,00	141109	○

→ gel, für geläppte Ausführung 20% Zuschlag

○ am Lager, Preis auf Anfrage

Preise für weitere Ausführungen auf Anfrage

→ gel, for lapped threads 20% extra charge

○ in stock, price on request

Prices for further versions on request



Präzisions-Schneideisen
 ≙ DIN EN 22568
Rundgewinde DIN 405
 Ausführung: mit Schälanschnitt

Precision thread cutting dies
 ≙ DIN EN 22568
 Knuckle thread DIN 405
 Specification: with spiral entry

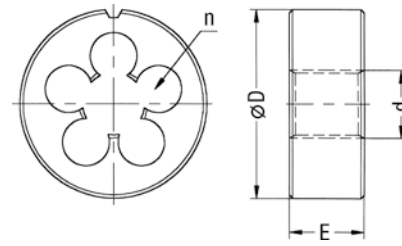
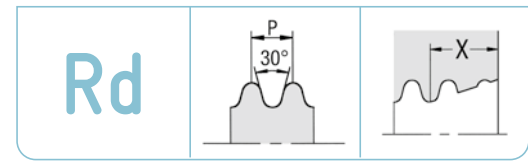

ORDER-CODE → RU →					
d	P Gg/1" tpi	Ø D x E mm	n	HSS 7h	
↓				$x = 1,75 \cdot P$	
				Art.-Nr.	€
Rd 8	10	30 x 11	4	103490	○
Rd 10	10	38 x 14	4	103467	205,00
Rd 11	10	38 x 14	4	103469	○
Rd 12	10	38 x 14	4	103471	138,00
Rd 14	8	45 x 18	4	103473	164,00
Rd 16	8	45 x 18	4	103474	153,00
Rd 18	8	45 x 18	5	103475	225,00
Rd 20	8	55 x 22	5	103477	216,00
Rd 22	8	55 x 22	5	103478	○
Rd 24	8	55 x 22	5	103479	216,00
Rd 26	8	65 x 25	5	103480	○
Rd 28	8	65 x 25	6	103481	○
Rd 30	8	65 x 25	6	103482	271,00
Rd 32	8	65 x 25	6	103483	○
Rd 36	8	65 x 25	7	103484	○
Rd 38	8	75 x 30	7	103485	○
Rd 40	6	75 x 30	7	103486	○

→ gel, für geläppte Ausführung 20% Zuschlag
 ○ am Lager, Preis auf Anfrage

→ gel, for lapped threads 20% extra charge
 ○ in stock, price on request



Schneideisenhalter DIN EN 22568

für geschlitzte und geschlossene Schneideisen
nach DIN EN 22568/24231/24230 und DIN 40434

Ausführung:

<75 Körper aus Druckguß

≥75 Körper aus Stahl, brüniert, Arme ausschraubbar

Precision die stocks DIN EN 22568

for split and solid dies acc.

DIN EN 22568/24231/24230 and DIN 40434

Specification:

<75 die cast body

≥75 body made of steel, bronzed, screw-in arms



ORDER-CODE → Halter →						Stückpreis price	
Größe dimension	Ganze Länge overall length [mm]	für Schneideisen Abmessungen for thread sizes				Art.-Nr.	€
16 x 5	160	bis/till M 2,6	M 2,6 x 0,25	3/32"	750049	7,70	
20 x 5	200	bis/till M 4	M 6 x 0,5	5/32"	750053	9,20	
20 x 7	200	bis/till M 6	M 6 x 0,75	1/4"	750054	9,20	
25 x 9	224	bis/till M 9	M 9 x 1	5/16"	750055	11,50	
30 x 11	280	bis/till M 11	M 11 x 1	7/16", G 1/8"	750056	13,10	
38 x 10	315	bis/till	M 15 x 1,5	G 1/4"	750057	16,40	
38 x 14	315	bis/till M 14		9/16"	750058	16,40	
45 x 14	450	bis/till	M 20 x 2	G 1/2"	750059	22,70	
45 x 18	450	bis/till M 20		13/16"	750060	22,70	
55 x 16	560	bis/till	M 26 x 2	G 3/4"	750061	34,00	
55 x 22	560	bis/till M 24		1"	750062	34,00	
65 x 18	630	bis/till	M 36 x 2	G 1"	750063	43,30	
65 x 25	630	bis/till M 36	M 36 x 3	1 3/8"	750064	43,30	
75 x 20	680	bis/till	M 42 x 3	G 1 1/4"	750065	112,00	
75 x 30	680	bis/till M 42		1 5/8"	750066	124,00	
90 x 22	820	bis/till	M 52 x 3	G 1 3/4"	750067	161,00	
90 x 36	820	bis/till M 52		2"	750068	176,00	
105 x 22	910	bis/till	M 68 x 3	G 2 1/4"	750041	253,00	
105 x 36	910	bis/till M 68		2 1/2"	750042	○	
120 x 22	920	bis/till	M 76 x 3	G 2 3/4"	750043	294,00	
120 x 36	920	bis/till	M 76 x 6	3"	750044	○	
130 x 25	930	bis/till	M 85 x 3	G 3"	750045	328,00	
130 x 36	930				750076	○	
140 x 25	940				750046	○	
150 x 25	950				750048	○	
160 x 25	960				750050	○	
170 x 25	970				750051	○	
180 x 25	980				750052	○	
190 x 25	990				750069	○	

○ am Lager, Preis auf Anfrage

Preise für größere Halter auf Anfrage

○ in stock, price on request

Prices for larger die stocks on request



M
MF
MJ
EG M

G
Rc, R
Pg

UNC
UNF
UN
UNJF

NPT
NPTF



M
MF
M keg.
M taper

G
BSW
BSF
DIN 477
R, BA, Pg

UNC
UNF
UNEF
UN, UNS

NPSM
NPT
NPTF
Tr, Rd



M
MF

G
BSW
BSF
R, Pg
MF-EL

UNC, UNF
UNEF
UN, UNS
UNJC
UNJF

NPT
NPTF
Tr
EG



M
MF
MJ
EG M

G
Rc, R
Pg

UNC
UNF
UN
UNJF

NPT
NPTF



M
MF
M keg.
M taper

G
BSW
BSF
DIN 477
R, BA, Pg

UNC
UNF
UNEF
UN, UNS

NPSM
NPT
NPTF
Tr, Rd



M
MF

G
BSW
BSF
R, Pg
MF-EL

UNC, UNF
UNEF
UN, UNS
UNJC
UNJF

NPT
NPTF
Tr
EG

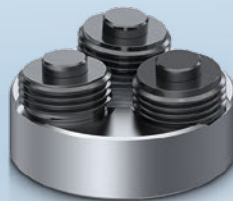



Hochleistungs-Gewinderolleisen

High Performance Thread Rolling Dies



M
MF
MJ
EG M

G
Rc, R
Pg

UNC
UNF
UN
UNJF

NPT
NPTF



M
MF
M keg.
M taper

G
BSW
BSF
DIN 477
R, BA, Pg

UNC
UNF
UNEF
UN, UNS

NPSM
NPT
NPTF
Tr, Rd



M
MF

G
BSW
BSF
R, Pg
MF-EL

UNC, UNF
UNEF
UN, UNS
UNJC
UNJF

NPT
NPTF
Tr
EG



M
MF
MJ
EG M

G
Rc, R
Pg

UNC
UNF
UN
UNJF

NPT
NPTF



M
MF
M keg.
M taper

G
BSW
BSF
DIN 477
R, BA, Pg

UNC
UNF
UNEF
UN, UNS

NPSM
NPT
NPTF
Tr, Rd



M
MF

G
BSW
BSF
R, Pg
MF-EL

UNC, UNF
UNEF
UN, UNS
UNJC
UNJF

NPT
NPTF
Tr
EG

Hochleistungs-Gewinderolleisen

High Performance Thread Rolling Dies

Allgemeine Information General Information

Übersicht Hochleistungs-Gewinderolleisen Seite/page 210
Overview High Performance Thread Rolling Dies

Technische Angaben Technical Information Seite/page 211

M

Metrisches ISO-Gewinde RB und RBV ISO metric thread RB and RBV Seite/page 213

Metrisches ISO-Gewinde RS und RSV ISO metric thread RS and RSV Seite/page 214

MF

Metrisches ISO-Feingewinde RS und RSV ISO metric fine thread RS and RSV Seite/page 215

UNC

UNC-Grobgewinde RS und RSV Unified national coarse thread RS and RSV Seite/page 216

UNF

UNF-Feingewinde RS und RSV Unified national fine thread RS and RSV Seite/page 217



M
MF
MJ
EG M

G
Rc, R
Pg

UNC
UNF
UN
UNJF

NPT
NPTF



M
MF
M keg.
M taper

G
BSW
BSF
DIN 477
R, BA, Pg

UNC
UNF
UNEF
UN, UNS

NPSM
NPT
NPTF
Tr, Rd



M
MF

G
BSW
BSF
R, Pg
MF-EL

UNC, UNF
UNEF
UN, UNS
UNJC
UNJF

NPT
NPTF
Tr
EG

Hochleistungs-Gewinderolleisen Boss Form

Hochbelastbar, Rollen wend- und tauschbar

High Performance Thread Rolling Dies Boss Pattern

High debitable, rolls turnable and exchangeable

RB

Starre Gewinderolleisen
Non-adjustable thread rolling dies



RBV

Verstellbare Gewinderolleisen
Adjustable thread rolling dies



Hochleistungs-Gewinderolleisen Schweizer Form

High Performance Thread Rolling Dies Swiss Pattern

RS

Starre Gewinderolleisen
Non-adjustable thread rolling dies



RSV

Verstellbare Gewinderolleisen
Adjustable thread rolling dies



Allgemeine Vorteile von JBO Hochleistungs-Gewinderolleisen:

General advantages of JBO High Performance Thread Rolling Dies:

- Gerollte Gewinde weisen eine deutlich höhere Festigkeit auf
- Keine Späne die das Bauteil beschädigen können
- Hervorragende Gewindeoberfläche
- Minimaler Platzbedarf durch kleinstmögliche Baumaße
- Kostengünstige Alternative zu marktüblichen Rollköpfen

Die Hochleistungs-Gewinderolleisen erlauben die spanlose Herstellung von Außengewinden. Diese Werkzeuge bieten gegenüber den Gewinderollköpfen verschiedener Hersteller den Vorteil, dass kleine bis mittlere Gewindedurchmesser mühelos auf diese Technologie umgestellt werden können, da die JBO-Hochleistungs-Gewinderolleisen den kleinstmöglichen Bauraum in Anspruch nehmen. Somit ist der Einsatz auch bei Bauteilen mit angrenzenden Störkonturen, als auch auf kleinen Drehmaschinen möglich.

- Rolled threads have a significantly higher strength
- No chips that can damage the component
- Excellent thread surface
- Minimal space requirement due to the smallest possible dimensions
- Cost-effective alternative to commercially available rolling heads

The high performance thread rolling dies allow the non-cutting production of external threads. Compared to the thread rolling heads of various manufacturers, these tools offer the advantage that small to medium thread diameters can be easily converted to this technology, as the JBO High Performance Rolling dies take up the smallest possible installation space. This means that they can also be used on components with contiguous interfering contours, as well as on small lathes.

Technische Angaben

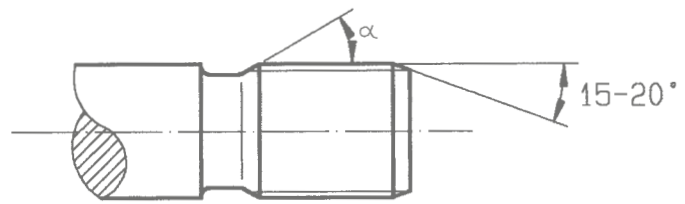

Gewinde	P [mm]	Vorbearbeitungs-Ø [mm] <small>Richtwert Tol. 6g ≤ M 1,4 Tol. 6h</small>
M 1	0,25	0,80
M 1,2	0,25	1,00
M 1,4	0,3	1,16
M 1,6	0,35	1,31
M 1,7	0,35	1,42
M 1,8	0,35	1,52
M 2	0,4	1,67
M 2,2	0,45	1,84
M 2,3	0,4	1,98
M 2,5	0,45	2,13
M 2,6	0,45	2,25
M 3	0,5	2,60
M 3,5	0,6	3,03
M 4	0,7	3,46
M 4,5	0,75	3,93
M 5	0,8	4,39
M 6	1	5,25
M 7	1	6,25
M 8	1,25	7,08
M 2,5	0,35	2,22
M 3	0,35	2,72
M 3,5	0,35	3,22
M 4	0,35	3,72
M 4	0,5	3,60
M 5	0,5	4,60
M 6	0,5	5,60
M 7	0,5	6,60
M 8	0,5	7,60
M 6	0,75	5,43
M 7	0,75	6,43
M 8	0,75	7,43
M 8	1	7,25
M 10	1	9,25

Gewinde	P [Gg/1"]	Vorbearbeitungs-Ø [mm] <small>Richtwert Tol. 2A</small>
UNC Nr. 1	64	1,55
UNC Nr. 2	56	1,84
UNC Nr. 3	48	2,10
UNC Nr. 4	40	2,36
UNC Nr. 5	40	2,69
UNC Nr. 6	32	2,91
UNC Nr. 8	32	3,57
UNC Nr. 10	24	4,05
UNF Nr. 0	80	1,27
UNF Nr. 1	72	1,58
UNF Nr. 2	64	1,87
UNF Nr. 3	56	2,15
UNF Nr. 4	48	2,43
UNF Nr. 5	44	2,73
UNF Nr. 6	40	3,02
UNF Nr. 8	36	3,63
UNF Nr. 10	32	4,23

Rollbare Werkstoffe

JBO-Gewinderolleisen sind geeignet für kaltverformbare Werkstoffe mit einer Mindestdehnung von ca. 8 % und bis ca. 900 N/mm² Festigkeit.

Werkstückvorbereitung

Das zu rollende Werkstück ist auf den Vorbearbeitungs-Ø herzustellen. Dieser ist wegen der Verschiedenheit der walzbaren Werkstoffe Richtwert und wird, wenn erforderlich, in Schritten von 0,01 mm vergrößert, bis das Gewindeprofil nahezu voll ausgebildet ist. Eine weitere Durchmesser vergrößerung würde das Werkzeug infolge Überbelastung schädigen. Beachten Sie bitte die Gewinde-Außen-Ø-Toleranzen. (siehe Seite 158 und 160).

Das Werkstück muss eine Fase von 15–20° erhalten, damit das Rolleisen leicht anrollt. Fase und Vorbearbeitungs-Ø müssen schlagfrei rundlaufen.

Ein Freistich am Gewindeende kann mit einem Übergangswinkel α bis ca. 30° ausgeführt werden. Ein rechtwinkliger Freistich hätte ein Ausbrechen der Gewinderollen zur Folge und müsste deshalb nach dem Gewinderollen angebracht werden.

Rollgeschwindigkeit

Wir empfehlen eine Rollgeschwindigkeit von 20 bis 50 m/min. Buntmetalle sind im oberen, Automatenstähle im mittleren und schwer bearbeitbare Stähle im unteren Schnittgeschwindigkeitsbereich zu rollen. Ausreichende Schmierung mit Schneidöl ist erforderlich.

JBO-Gewinderolleisen haben Rollen mit Vorwalzprofil

Man erreicht damit ein genaueres Gewindeprofil und eine höhere Steigungsgenauigkeit. Außerdem wirkt sich ein Vorwalzprofil bei schwieriger zu bearbeitendem Material vorteilhaft auf die Standzeit der Rollen aus.

Anleitung für das Einstellen

von verstellbaren Gewinderolleisen RSV mittels Rolleisen-Halter RSV 2 bis 10.

1. Rolleisen auf Halter legen, Mutter aufschrauben bis sie Rolleisen zentriert und leicht anliegt. Mit Gegenmutter kontern.
2. Werkstück-Außen-Ø auf Vorbearbeitungs-Ø-Richtwert drehen, Gewinde rollen, Flanken-Ø prüfen.
3. Bei Maßkorrektur erst den Flanken-Ø mit der Mutter einstellen. Dann den Gewinde-Außen-Ø durch Änderung des Vorbearbeitungs-Ø einstellen, wobei die Vorgehensweise in „Werkstückvorbereitung“ beschrieben ist.

Technical Information

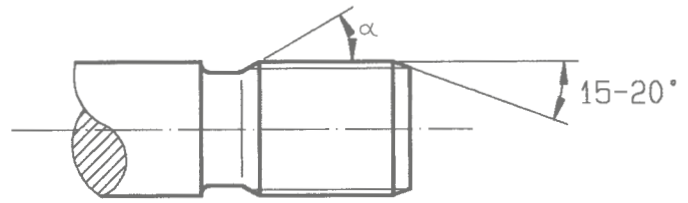

thread	P [mm]	blank dia. [mm]
		guide val. tol. 6g ≤ M 1,4 tol. 6h
M 1	0,25	0,80
M 1,2	0,25	1,00
M 1,4	0,3	1,16
M 1,6	0,35	1,31
M 1,7	0,35	1,42
M 1,8	0,35	1,52
M 2	0,4	1,67
M 2,2	0,45	1,84
M 2,3	0,4	1,98
M 2,5	0,45	2,13
M 2,6	0,45	2,25
M 3	0,5	2,60
M 3,5	0,6	3,03
M 4	0,7	3,46
M 4,5	0,75	3,93
M 5	0,8	4,39
M 6	1	5,25
M 7	1	6,25
M 8	1,25	7,08
M 2,5	0,35	2,22
M 3	0,35	2,72
M 3,5	0,35	3,22
M 4	0,35	3,72
M 4	0,5	3,60
M 5	0,5	4,60
M 6	0,5	5,60
M 7	0,5	6,60
M 8	0,5	7,60
M 6	0,75	5,43
M 7	0,75	6,43
M 8	0,75	7,43
M 8	1	7,25
M 10	1	9,25

thread	P [Gg/1"]	blank dia. [mm]
		guide val.tol. 2A
UNC Nr. 1	64	1,55
UNC Nr. 2	56	1,84
UNC Nr. 3	48	2,10
UNC Nr. 4	40	2,36
UNC Nr. 5	40	2,69
UNC Nr. 6	32	2,91
UNC Nr. 8	32	3,57
UNC Nr. 10	24	4,05
UNF Nr. 0	80	1,27
UNF Nr. 1	72	1,58
UNF Nr. 2	64	1,87
UNF Nr. 3	56	2,15
UNF Nr. 4	48	2,43
UNF Nr. 5	44	2,73
UNF Nr. 6	40	3,02
UNF Nr. 8	36	3,63
UNF Nr. 10	32	4,23

Rollable materials

JBO thread rolling dies are suitable for coldformable materials with a minimum elongation of approx. 8% and up to approx. 900 N/mm² tensile strength.

Workpiece preparation

The workpiece to be rolled must be prepared to the blank diameter. This corresponds to the standard value due to the difference in the materials that can be rolled and, if necessary, is increased in steps of 0.01 mm until the thread profile is almost fully formed. A further increase in diameter would damage the tool due to overloading. Please observe the thread major diameter tolerances (see pages 158 and 160).

The workpiece must have a 15-20° chamfer so that the rolling die rolls on easily.

Both chamfer and blank diameter must run concentrically. The transition between the blank diameter and any undercut at the end of the thread should be at an angle α of approx. 30°. A 90° undercut causes chipping of the thread rolls and must therefore be machined after thread rolling.

Rolling speed

We recommend thread rolling speeds ranging from 20 to 50 m/min. The top speeds are suitable for brass and bronze and medium speeds for free-cutting steels. The lower speeds have to be used for steels that are difficult to form. Adequate lubrication with cutting oil is necessary.

JBO thread rolling dies have thread rolls with lead profile. A more accurate thread profile and a more accurate pitch are thereby achieved. With materials that are difficult to form, the lead profile also extends the life of the thread rolls.

Setting instructions

adjustable thread rolling dies RSV by means of thread rolling die holder RSV 2 to 10.

1. Place the rolling die on the die holder, screw on the nut until it is centred and lightly in contact. Lock with locknut.
2. Turn workpiece outer diameter to guide value of the blank diameter, roll thread, check effective diameter.
3. To correct the thread dimensions, first adjust the effective diameter with the nut. Then correct the thread maximum diameter by altering the blank diameter in accordance with the procedure described in "Workpiece preparation".

Hochleistungs-Gewinderolleisen Boss Form

Metrisches ISO-Gewinde DIN 13

Ausführung: hochbelastbar, für hohe Steigungs- und Profilgenauigkeit, nitrierte Rollen mit Vorwalzprofil

High performance thread rolling dies Boss pattern

ISO metric thread DIN 13

Specification: heavy duty, for highest pitch and profile accuracy, nitrided thread rolls with lead profile

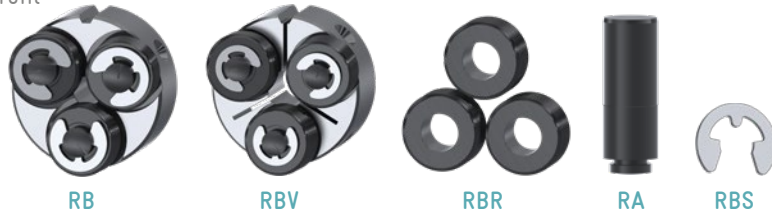

ORDER-CODE →			RB	RBV	RBR	RA	RBS
Gewinde thread	P mm	zu verwendende Haltergröße die stocks to use	6g starre Ausführung non-adjustable design	6g, 6e, 6h verstellbare Ausführung adjustable design	Ersatz Gewinderollen 1 Satz spare thread rolls 1 set	Ersatz Achsen 1 Satz spare axes 1 set	Ersatz Sicherungs-scheiben 1 Stück spare circlips 1 each
↓							
			Art.-Nr. €	Art.-Nr. €	Art.-Nr. €	Art.-Nr. €	Art.-Nr. €
M 3	0,5	20 x 7	200011 144,00	200025 167,00	200002 51,80	200265 44,00	200260 2,10
M 4	0,7	25 x 9	200013 151,00	200026 176,00	200003 52,80	200180 44,00	200510 2,10
M 5	0,8	25 x 9	200016 151,00	200027 176,00	200004 52,80	200221 44,00	200346 2,10
M 6	1	30 x 11	200017 161,00	200029 192,00	200005 54,10	200222 44,00	200345 2,10
M 8	1,25	38 x 14	200020 205,00	200033 248,00	200007 66,60	200231 55,80	200511 2,10

Alle Abmessungen können auch in „links“ angeboten werden.

All dimensions can also be offered in "left hand".

Normale Halter

Diese Gewinderolleisen werden mit handelsüblichen Haltern wie Schneideisen nach DIN EN 22568 (Haltergröße siehe Tabelle) aufgenommen.

Normal die stocks

These thread rolling dies are mounted in normal die stocks like DIN EN 22568 (for die holder size see table).

Rollen wendbar

Die Rollen sind zur axialen Sicherung mit Sicherungsscheiben fixiert. Sind nach längerem Einsatz die Rollen einseitig abgenutzt, werden die Sicherungsscheiben z. B. mittels Schraubenzieher radial abgeschoben und die Rollen gewendet.

Reversible thread rolls

The thread rolls are retained axially by circlips. If, after prolonged use, the thread rolls have become worn on one side, then the rolls can be reversed after the circlips have been pushed off radially, e.g. with a screw driver.

Gewinderollensätze lieferbar

Verbrauchte Rollensätze können durch neue ersetzt werden. Bei der Montage ist zu beachten, dass die Reihenfolge der verschiedenen Rollen eingehalten wird. Rolle Nr. 1 kommt auf die Achse, an der die stirnseitige Ausfräsung des Körpers die geringste Tiefe aufweist*. Die Montage muss im Uhrzeigersinn fortgesetzt werden.

Spare sets of thread rolls suppliable

Spare sets of thread rolls can be supplied to replace worn sets. The new rolls have to be fitted in the correct sequence. Roll no. 1 has to be fitted into the shallowest recess in the face of the die body.* The remaining rolls are fitted clockwise.

* siehe auch Schaubild – Rolle Nr.1 rechts von der Nut

* see also graph – roll no.1 right of the flute

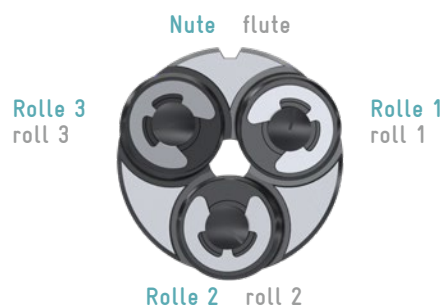

Hochleistungs-Gewinderolleisen Schweizer Form

Metrisches ISO-Gewinde DIN 13

Ausführung: nitrierte Rollen

High performance thread rolling dies
Swiss pattern

ISO metric thread DIN 13

Specification: nitrided thread rolls

M

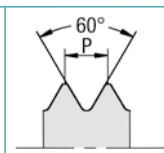

RS



RSV



ORDER-CODE →		RS				RSV					
Gewinde thread	P mm	6g starre Ausführung non-adjustable design ≤ M 1,4 Tol. 6h	Außen-Ø x Breite mm outside dia. x height mm	Rolleisen-Halter rolling die stocks		Rolleisen-Halter Best-Nr. rolling die stocks order-code	6g, 6e, 6h verstellbare Ausführung adjustable design	Außen-Ø x Breite mm outside dia. x height mm	Rolleisen-Halter rolling die stocks		Rolleisen-Halter Best-Nr. rolling die stocks order-code
				Art.-Nr.	€				Art.-Nr.	€	
↓				Schaft shank	↓			Schaft shank	↓		

Ohne Vorwalzprofil, dadurch kann näher an einen Bund gerollt werden														Without lead profile, this enables rolling right to collar													
M 1	0,25	200036	39,30	8 x 4,5	200184	○	5	RS 2	200091	48,60	10 x 6	200189	○	5	RSV 2												
M 1,2	0,25	200037	39,30	8 x 4,5	200184	○	5	RS 2	200092	48,60	10 x 6	200189	○	5	RSV 2												
M 1,4	0,3	200038	49,00	8 /10 x 6	200184	○	5	RS 2	200093	58,90	10 x 6	200189	○	5	RSV 2												
M 1,6	0,35	200590	49,60	12 x 6	200185	○	5	RS 3	200667	○	14 x 6	200190	○	5	RSV 3												
M 1,7	0,35	200622	49,60	12 x 6	200185	○	5	RS 3	200668	○	14 x 6	200190	○	5	RSV 3												
M 1,8	0,35	200655	49,60	12 x 6	200185	○	5	RS 3	200669	○	14 x 6	200190	○	5	RSV 3												
M 2	0,4	200624	49,60	12 x 6	200185	○	5	RS 3	200670	○	14 x 6	200190	○	5	RSV 3												

Mit Vorwalzprofil, für sehr hohe Steigungsgenauigkeiten und Werkzeugstandzeiten														With lead profile, for a very high pitch accuracy and tool durability													
M 1,6	0,35	200039	49,60	12 x 6	200185	○	5	RS 3	200094	59,50	14 x 6	200190	○	5	RSV 3												
M 1,7	0,35	200040	49,60	12 x 6	200185	○	5	RS 3	200095	59,50	14 x 6	200190	○	5	RSV 3												
M 1,8	0,35	200041	49,60	12 x 6	200185	○	5	RS 3	200096	59,50	14 x 6	200190	○	5	RSV 3												
M 2	0,4	200043	49,60	12 x 6	200185	○	5	RS 3	200102	59,50	14 x 6	200190	○	5	RSV 3												
M 2,2	0,45	200045	58,20	12 /16 x 8	200185	○	5	RS 3	200104	71,60	16 x 8	200191	○	6	RSV 4												
M 2,3	0,4	200046	58,20	12 x 6	200185	○	5	RS 3	200105	71,60	14 x 6	200190	○	5	RSV 3												
M 2,5	0,45	200047	58,20	12 /16 x 8	200185	○	5	RS 3	200106	71,60	16 x 8	200191	○	6	RSV 4												
M 2,6	0,45	200050	58,20	12 /16 x 8	200185	○	5	RS 3	200110	71,60	16 x 8	200191	○	6	RSV 4												
M 3-12	0,5	200052	58,20	12 /16 x 8	200185	○	5	RS 3	200113	71,60	16 x 8	200191	○	6	RSV 4												
M 3	0,5	200051	70,10	21,5/23 x 11	200186	○	8	RS 4	200112	85,60	25 x 11	200192	○	8	RSV 5												
M 3,5	0,6	200054	70,10	21,5/23 x 11	200186	○	8	RS 4	200116	85,60	25 x 11	200192	○	8	RSV 5												
M 4	0,7	200057	70,10	21,5/23 x 11	200186	○	8	RS 4	200118	85,60	25 x 11	200192	○	8	RSV 5												
M 4,5	0,75	200060	88,90	25 x 13	200186	○	8	RS 4	200122	107,00	26,7 x 13	200193	○	8	RSV 6												
M 5	0,8	200061	88,90	25 x 13	200186	○	8	RS 4	200124	107,00	26,7 x 13	200193	○	8	RSV 6												
M 6	1	200065	99,40	29,5/30 x 16	200551	○	10	RS 5	200127	120,00	31,75 x 16	200194	○	12	RSV 8												

Alle Abmessungen können auch in „links“ angeboten werden.
Alternativ können weitere Schaft-Ø geliefert werden

All dimensions can also be offered in "left hand".
Alternatively other shank-Ø can be supplied

○ am Lager, Preis auf Anfrage
Preise für Sondergewinde auf Anfrage

○ in stock, price on request
Prices for special threads on request



Hochleistung-Gewinderolleisen Schweizer Form

Metrisches ISO-Feingewinde DIN 13

Ausführung: für hohe Steigungs- und Profildgenauigkeit,
nitrierte Rollen mit Vorwalzprofil

**High performance thread rolling dies
Swiss pattern**

ISO metric fine thread DIN 13

Specification: for highest pitch and profile accuracy,
nitrided thread rolls with lead profile

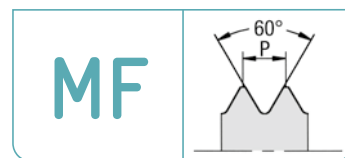

RS



RSV



ORDER-CODE →		RS				RSV									
Gewinde thread	P mm	6g starre Ausführung non-adjustable design ≤ M 1,4 Tol. 6h	Außen-Ø x Breite mm outside dia. x height mm	Rolleisen-Halter rolling die stocks	Rolleisen- Halter Best-Nr. rolling die stocks order-code	6g, 6e, 6h verstellbare Ausführung adjustable design	Außen-Ø x Breite mm outside dia. x height mm	Rolleisen-Halter rolling die stocks	Rolleisen- Halter Best-Nr. rolling die stocks order-code						
↓				Schaft shank	↓			Schaft shank	↓						
		Art.-Nr.	€		Art.-Nr.	€	Ø		Art.-Nr.	€	Ø				
M 3	0,35	200053	81,90	12 /16 x 8	200185	○	5	RS 3	200115	98,00	14 x 6	200190	○	5	RSV 3
M 3,5	0,35	200056	81,90	12 /16 x 8	200185	○	5	RS 3	200117	98,00	16 x 8	200191	○	6	RSV 4
M 4	0,35	200058	81,90	12 /16 x 8	200185	○	5	RS 3	200119	98,00	16 x 8	200191	○	6	RSV 4
M 4	0,5	200059	114,00	21,5/24 x 11	200186	○	8	RS 4	200120	141,00	25 x 11	200192	○	8	RSV 5
M 5	0,5	200063	126,00	25 x 11	200186	○	8	RS 4	200125	153,00	26,7 x 11	200193	○	8	RSV 6
M 6	0,5	200066	139,00	29,5 x 13	200551	○	10	RS 5	200129	153,00	26,7 x 11	200193	○	8	RSV 6
M 6	0,75	200067	147,00	29,5 x 14,5	200551	○	10	RS 5	200130	157,00	26,7 x 13	200193	○	8	RSV 6
M 8	0,75	200072	147,00	29,5 x 14,5	200551	○	10	RS 5	200135	173,00	31,75 x 14,5	200194	○	12	RSV 8
M 8	1	200073	147,00	29,5 x 16	200551	○	10	RS 5	200136	192,00	35 x 16	200195	○	14	RSV 10
M 10	1								200098	211,00	35 x 16	200195	○	14	RSV 10

Alle Abmessungen können auch in „links“ angeboten werden
Alternativ können weitere Schaft-Ø geliefert werden

○ am Lager, Preis auf Anfrage
Preise für Sondergewinde auf Anfrage

All dimensions can also be offered in "left hand".
Alternatively other shank-Ø can be supplied

○ in stock, price on request
Prices for special threads on request



M
MF
MJ
EG M

6
Rc, R
Pg

UNC
UNF
UN
UNJF

NPT
NPTF



M
MF
M keg.
M taper

6
BSW
BSF
DIN 477
R, BA, Pg

UNC
UNF
UNEF
UN, UNS

NPSM
NPT
NPTF
Tr, Rd



M
MF

6
BSW
BSF
R, Pg
MF-EL

UNC, UNF
UNEF
UN, UNS
UNJC
UNJF

NPT
NPTF
Tr
EG

Hochleistungs-Gewinderolleisen Schweizer Form

UNC-Grobgewinde ASME B1.1

Ausführung: nitrierte Rollen

High performance thread rolling dies
Swiss pattern

Unified national coarse thread ASME B1.1
Specification: nitrided thread rolls

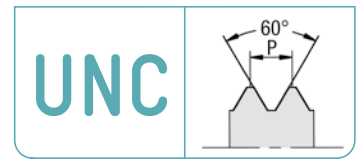

RS



RSV



ORDER-CODE →			RS				RSV									
Gewinde thread	Ø d mm	P Gg/1" tpi	2A starre Ausführung non-adjustable design		Außen-Ø x Breite mm outside dia. x height mm	Rolleisen-Halter rolling die stocks		Rolleisen-Halter Best-Nr. rolling die stocks order-code	2A, 1A, 3A verstellbare Ausführung adjustable design		Außen-Ø x Breite mm outside dia. x height mm	Rolleisen-Halter rolling die stocks		Rolleisen-Halter Best-Nr. rolling die stocks order-code		
↓						Schaft shank		↓				Schaft shank		↓		
UNC Nr.			Art.-Nr.	€		Art.-Nr.	€	Ø	RS	Art.-Nr.	€		Art.-Nr.	€	Ø	RSV
1	1,85	64	200075	62,70	12 x 6	200185	○	5	RS 3	200137	75,40	14 x 6	200190	○	5	RSV 3
2	2,18	56	200077	69,80	12 /16 x 8	200185	○	5	RS 3	200139	83,90	16 x 8	200191	○	6	RSV 4
3	2,52	48	200078	97,80	21,5/23 x 11	200186	○	8	RS 4	200140	119,00	25 x 11	200192	○	8	RSV 5
4	2,85	40	200079	97,80	21,5/23 x 11	200186	○	8	RS 4	200141	119,00	25 x 11	200192	○	8	RSV 5
5	3,18	40			21,5/23 x 11	200186	○	8	RS 4	200142	119,00	25 x 11	200192	○	8	RSV 5
6	3,51	32	200081	126,00	21,5/23 x 11	200186	○	8	RS 4	200143	148,00	25 x 11	200192	○	8	RSV 5
8	4,17	32	200082	126,00	21,5/23 x 11	200186	○	8	RS 4	200144	148,00	25 x 11	200192	○	8	RSV 5
10	4,83	24			25 x 13	200186	○	8	RS 4	200138	305,00	26,7 x 15	200193	○	8	RSV 6

Alle Abmessungen können auch in „links“ angeboten werden
Alternativ können weitere Schaft-Ø geliefert werden

All dimensions can also be offered in "left hand".
Alternatively other shank-Ø can be supplied

○ am Lager, Preis auf Anfrage
Preise für weitere Gewinde auf Anfrage

○ in stock, price on request
Prices for further threads on request



Hochleistungs-Gewinderolleisen Schweizer Form

UNF-Feingewinde ASME B1.1

Ausführung: nitrierte Rollen

High performance thread rolling dies
Swiss pattern

Unified national fine thread ASME B1.1
Specification: nitrided thread rolls

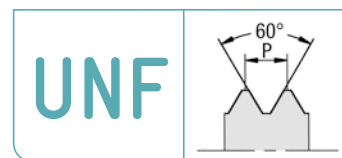



RS



RSV



ORDER-CODE →			RS				RSV				RSV					
Gewinde thread	Ø d mm	P Gg/1" tpi	2A starre Ausführung non-adjustable design	Außen-Ø x Breite mm outside dia. x height mm	Rolleisen-Halter rolling die stocks		Rolleisen-Halter Best-Nr. rolling die stocks order-code	2A, 1A, 3A verstellbare Ausführung adjustable design	Außen-Ø x Breite mm outside dia. x height mm	Rolleisen-Halter rolling die stocks		Rolleisen-Halter Best-Nr. rolling die stocks order-code				
↓						Schaft shank	↓				Schaft shank	↓				
			Art.-Nr.	€		Art.-Nr.	€	Ø		Art.-Nr.	€		Art.-Nr.	€	Ø	
UNF Nr. 0	1,52	80	200301	49,60	8 /10 x 6	200184	○	5	RS 2	200232	61,30	10 x 6	200189	○	5	RSV 2
UNF Nr. 1	1,85	72	200083	62,70	12 x 6	200185	○	5	RS 3	200145	75,40	14 x 6	200190	○	5	RSV 3
UNF Nr. 2	2,18	64	200085	62,70	12 x 6	200185	○	5	RS 3	200147	75,40	14 x 6	200190	○	5	RSV 3
UNF Nr. 3	2,52	56	200086	69,80	12 /16 x 8	200185	○	5	RS 3	200148	83,90	16 x 8	200191	○	6	RSV 4
UNF Nr. 4	2,85	48	200087	97,80	21,5/23 x 11	200186	○	8	RS 4	200149	119,00	25 x 11	200192	○	8	RSV 5
UNF Nr. 5	3,18	44	200088	97,80	21,5/23 x 11	200186	○	8	RS 4	200150	126,00	25 x 11	200192	○	8	RSV 5
UNF Nr. 6	3,51	40	200089	97,80	21,5/23 x 11	200186	○	8	RS 4	200151	126,00	25 x 11	200192	○	8	RSV 5
UNF Nr. 8	4,17	36								200152	148,00	25 x 11	200192	○	8	RSV 5
UNF Nr. 10	4,83	32	200084	126,00	21,5/23 x 11	200186	○	8	RS 4	200146	148,00	25 x 11	200192	○	8	RSV 5

Alle Abmessungen können auch in „links“ angeboten werden.
Alternativ können weitere Schaft-Ø geliefert werden

○ am Lager, Preis auf Anfrage
Preise für weitere Gewinde auf Anfrage

All dimensions can also be offered in "left hand".
Alternatively other shank-Ø can be supplied

○ in stock, price on request
Prices for further threads on request



- M
MF
MJ
EG M
- G
Rc, R
Pg
- UNC
UNF
UN
UNJF
- NPT
NPTF
- M
MF
M keg.
M taper
- G
BSW
BSF
DIN 477
R, BA, Pg
- UNC
UNF
UNEF
UN, UNS
- NPSM
NPT
NPTF
Tr, Rd
- M
MF
- G
BSW
BSF
R, Pg
MF-EL
- UNC, UNF
UNEF
UN, UNS
UNJC
UNJF
- NPT
NPTF
Tr
EG

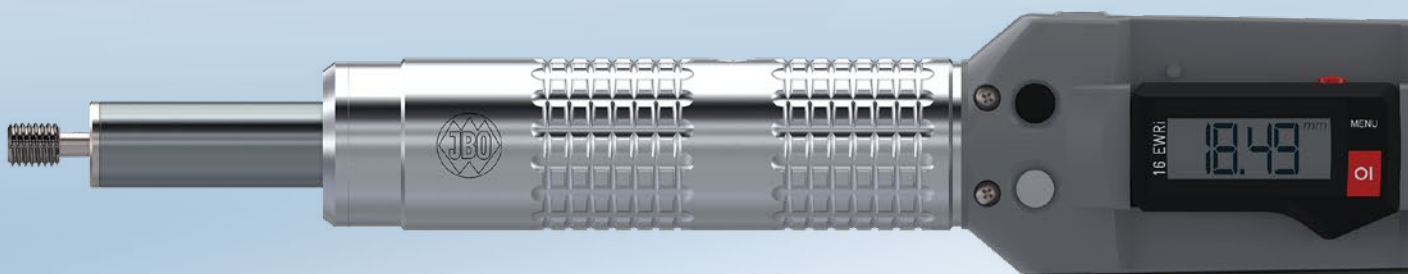
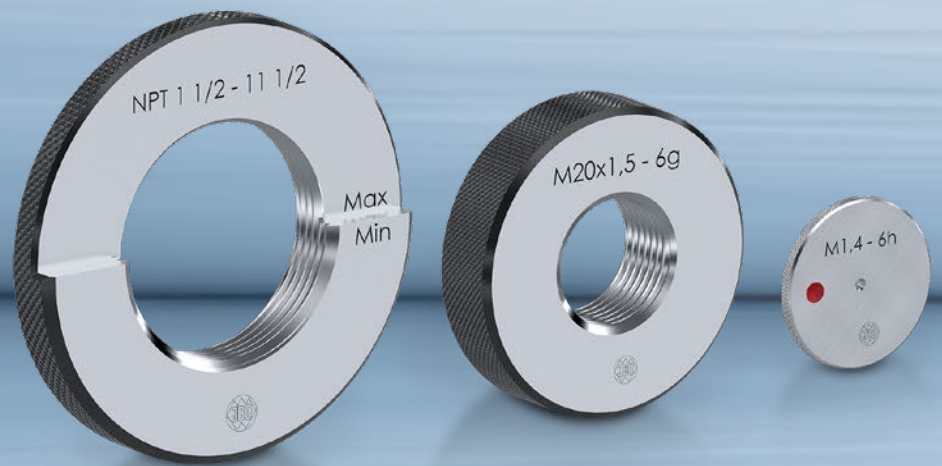



Präzisions-Gewindelehren

Precision Thread Gauges



- M
MF
MJ
EG M
- G
Rc, R
Pg
- UNC
UNF
UN
UNJF
- NPT
NPTF
- M
MF
M keg.
M taper
- G
BSW
BSF
DIN 477
R, BA, Pg
- UNC
UNF
UNEF
UN, UNS
- NPSM
NPT
NPTF
Tr, Rd
- M
MF
- G
BSW
BSF
R, Pg
MF-EL
- UNC, UNF
UNEF
UN, UNS
UNJC
UNJF
- NPT
NPTF
Tr
EG



M
MF
MJ
EG M

G
Rc, R
Pg

UNC
UNF
UN
UNJF

NPT
NPTF



M
MF
M keg.
M taper

G
BSW
BSF
DIN 477
R, BA, Pg

UNC
UNF
UNEF
UN, UNS

NPSM
NPT
NPTF
Tr, Rd



M
MF

G
BSW
BSF
R, Pg
MF-EL

UNC, UNF
UNEF
UN, UNS
UNJC
UNJF

NPT
NPTF
Tr
EG

Präzisions-Gewindelehren

Precision Thread Gauges

Allgemeine Information General Information

JBO-Gewindelehren – ein Begriff für Qualität und Verschleißfestigkeit JBO Thread Gauges – a concept for quality and wear resistance	Seite/page	222
Übersicht Präzisions-Gewindelehren <small>Overview Precision Thread Gauges</small>	Seite/page	223
Sonder-Gewindelehren und Prüfaufnahmen <small>Special Thread Gauges and Inspection Machine Mountings</small>	Seite/page	224
Sonderlängen bei Gewinde-Grenzlehndornen <small>Special length on GO/NOT GO Thread Plug Gauges</small>	Seite/page	227
Allgemeine Informationen MultiCheck <small>General Information MultiCheck</small>	Seite/page	228
Allgemeine Informationen eMultiCheck <small>General Information eMultiCheck</small>	Seite/page	231
Anwendung von Gewindelehren <small>Use of Thread Gauges</small>	Seite/page	232
„FAST LINE“ Express Fertigung <small>“FAST LINE“ express production</small>	Seite/page	235
JBO-Kalibrierservice, DAkkS-Kalibrierscheine, Werkskalibrierscheine JBO calibration service, DAkkS Calibration Certificates, Calibration Certificates	Seite/page	236

M Metrisches ISO-Gewinde <small>ISO metric thread</small>	Seite/page	240
MF Metrisches ISO-Feingewinde <small>ISO metric fine thread</small>	Seite/page	249

G Whitworth-Rohrgewinde <small>Whitworth pipe thread</small>	Seite/page	294
BSW Whitworth-Gewinde <small>British Standard Whitworth thread</small>	Seite/page	298
BSF Whitworth-Feingewinde <small>British Standard Whitworth fine thread</small>	Seite/page	299
R Kegeliges Whitworth-Rohrgewinde <small>Tapered Whitworth pipe thread</small>	Seite/page	300
Pg Stahlpanzerrohr-Gewinde <small>Steel conduit thread</small>	Seite/page	302
MF-EL Gewinde für Elektroinstallationsrohre <small>Electrical conduit thread</small>	Seite/page	303

UNC UNC-Grobgewinde <small>Unified national coarse thread</small>	Seite/page	304
UNF UNF-Feingewinde <small>Unified national fine thread</small>	Seite/page	306
UNEF UNEF-Extra Feingewinde <small>Unified national extra fine thread</small>	Seite/page	308
UN/UNS UN-Gewinde, UNS-Spezialgewinde <small>Unified national thread, Unified national special thread</small>	Seite/page	309
UNJC UNJC-Grobgewinde <small>UNJC Unified national coarse thread</small>	Seite/page	310
UNJF UNJF-Feingewinde <small>UNJF Unified national fine thread</small>	Seite/page	311

NPT NPT-Kegeliges Amerikanisches Rohrgewinde <small>American Standard taper pipe thread</small>	Seite/page	312
NPTF NPTF-Kegeliges Amerikanisches Rohrgewinde <small>American Standard taper pipe thread</small>	Seite/page	313
Tr Metrisches ISO-Trapez-Gewinde <small>ISO metric trapezoidal thread</small>	Seite/page	314
EG (STI) Einsatzgewinde M/MF/UNC/UNF <small>Threads for wire inserts M/MF/UNC/UNF</small>	Seite/page	315

JBO-Gewindelehren – ein Begriff für Qualität und Verschleißfestigkeit

JBO Thread Gauges – a concept for quality and wear resistance

Hervorragendes Verschleißverhalten durch höchste Oberflächengüte der Gewindeflanken und hohe Härte ≥ 62 HRC für lange Lebensdauer.

Excellent wear behaviour due to supreme surface finish of thread flanks and high hardness ≥ 62 HRC for long gauge life.

Das mehrmalige Anlassen nach dem Härteprozess garantiert hohe Form- und Maßstabilität.

Repeated tempering after the annealing process guarantees high form stability and dimensional stability.

Wenn es die Gewindelehren-Toleranz zulässt, wird in eingeschränkter Toleranz gefertigt.

Gauges are produced to the reduced tolerance wherever permitted by the overall gauge tolerance.

Messunsicherheit
Uncertainty of measuring

Eingeschränkte Toleranz (Bereich der Übereinstimmung)
Reduced tolerance (region of conformity)

Messunsicherheit
Uncertainty of measuring

Gewindelehren-Toleranz
Thread gauge tolerance

Großes Lager mit über 10.000 verschiedenen Gewindeabmessungen und Toleranzen für schnelle Lieferung.

Large stocks covering more than 10,000 different thread dimensions and tolerances for quick delivery.

Mit unserer außergewöhnlichen Lagervielfalt sind wir der Marktführer.

We are the market leader with our exceptional stock holding and variety of thread sizes.

Das gesamte Spektrum von Gewinde- \varnothing 0,5 - 300 mm für alle Gewindearten.

Complete range of gauges covering all kinds of threads from 0.5 - 300 mm diameter.

Lieferung erfolgt in Einzelverpackungen, die dauerhaften Schutz gewährleisten.

Gauges are supplied in individual packing for permanent protection.



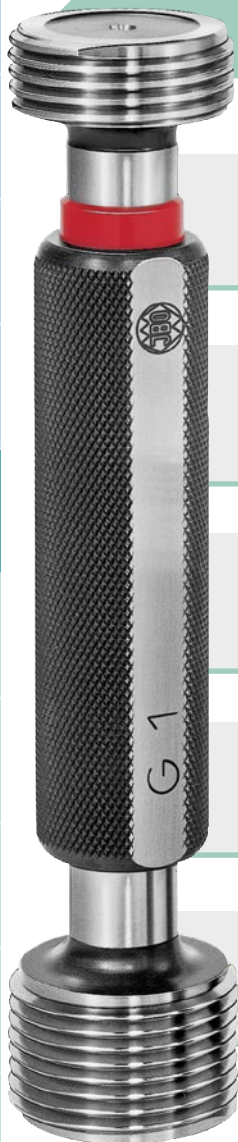

Auf Wunsch mit Kalibrierschein.

Calibration certificate on request.



Präzisions-Gewindelehren

Precision Thread Gauges

LD	GD	AD	LD
 <p>LD LD-DLC</p>			
<p>LD Gewinde-Grenzlehndorn, Baumaße nach DIN 2280 bis Nenn-Ø 40 mm LD GO/NOT GO thread plug gauge, dimensions according DIN 2280 till major-Ø 40 mm</p> <p>LD-DLC Gewinde-Grenzlehndorn, GD DLC-beschichtet LD-DLC GO/NOT GO thread plug gauge, GO side DLC coated</p>	<p>Gewinde-Gutlehdorn Baumaße nach DIN 2281-1 über Nenn-Ø 40 mm DIN 2281-2</p> <p>GO thread plug gauge Dimensions according DIN 2281-1 above major-Ø 40 mm DIN 2281-2</p>	<p>Gewinde-Ausschusslehndorn Baumaße nach DIN 2283-1 über Nenn-Ø 40 mm DIN 2283-2</p> <p>NOT GO thread plug gauge dimensions according DIN 2283-1 above major-Ø 40 mm DIN 2283-2</p>	<p>Gewinde-Grenzlehndorn kegelig mit Meßstufe GO/NOT GO thread plug gauge conical with step limit</p>

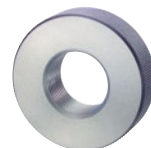
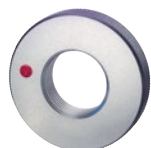
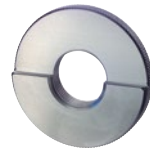
KD	GR	AR	LR
			
<p>Koordinatenmessdorn Bestimmung der Position und Winkligkeit eines Innengewindes mittels 3D Messmaschine</p> <p>Coordinate gauge rod Determination of position and angularity of the thread via 3D measuring machine</p>	<p>Gewinde-Gutlehring Baumaße nach DIN 2285-1</p> <p>GO thread ring gauge Dimensions according DIN 2285-1</p>	<p>Gewinde-Ausschusslehring Baumaße nach DIN 2299-1</p> <p>NOT GO thread ring gauge Dimensions according DIN 2299-1</p>	<p>Gewinde-Grenzlehring mit Meßstufe GO/NOT GO thread ring gauge for tapered thread with step limit</p>

Gewindelehren-Sätze für metrisches ISO-Regelgewinde nach DIN 13

Thread Gauges sets for ISO metric thread according DIN 13



Art.-Nr. 563738
art.-no.

Gewinde-Gutlehdorne M3, M4, M5, M6, M8, M10, M12
Toleranz 6H mit DLC-Beschichtung HV 0,05 > 5000

GO thread plug gauges M3, M4, M5, M6, M8, M10, M12
tolerance 6H with DLC coating HV 0.05 > 5000

Preis auf Anfrage Price on request



Art.-Nr. 239334
art.-no.

Gewinde-Gutlehringe M3, M4, M5, M6, M8, M10, M12
Toleranz 6g mit DLC-Beschichtung HV 0,05 > 5000

GO thread ring gauges M3, M4, M5, M6, M8, M10, M12
tolerance 6g with DLC coating HV 0.05 > 5000

Preis auf Anfrage Price on request

M
MF
MJ
EG M

G
Rc, R
Pg

UNC
UNF
UN
UNJF

NPT
NPTF

M
MF
M keg.
M taper

G
BSW
BSF
DIN 477
R, BA, Pg

UNC
UNF
UNEF
UN, UNS

NPSM
NPT
NPTF
Tr, Rd

M
MF

G
BSW
BSF
R, Pg
MF-EL

UNC, UNF
UNEF
UN, UNS
UNJF
UNJC
UNJF

NPT
NPTF
Tr
EG

Kunden-individuelle Sonder-Gewindelehren und Prüfaufnahmen

Special Client-Specific Thread Gauges and Inspection Machine Mountings

- 1 Gewinde-Grenzlehndorn und Gewinde-Gutlehherring für kundenspezifisches 3-gängiges Sondergewinde.

GO/NOT GO thread plug gauge and GO thread ring gauge for customer-specific 3-starts special thread.

- 2 Gewinde-Grenzlehndorn zur Prüfung kleiner, tiefliegender Gewinde. Hals-Ø verstärkt.

GO/NOT GO thread plug gauge with increased stem diameter for checking small, deep seated threads.

- 3 Der Gewindering, eingebaut in eine Prüfvorrichtung, dient zur Rund- und Planlaufprüfung von Teilen. Zur zentrischen Aufnahme ist das Gewinde leicht kegelig ausgeführt.

Thread ring gauge for mounting in inspection equipment to check radial and axial run-out. The thread of the gauge is lightly tapered to facilitate centring of the workpiece.

- 4 Gewinde-Grenzlehndorn und Gewinde-Gutlehherring für kundenspezifisches unsymmetrisches Sondergewinde.

GO/NOT GO thread plug gauge and GO thread ring gauge for customer-specific asymmetric special thread.

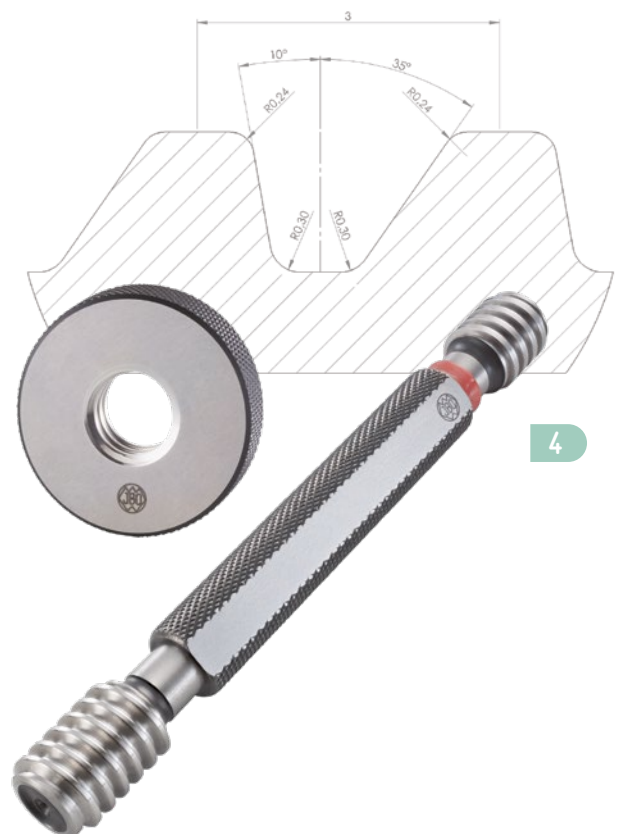
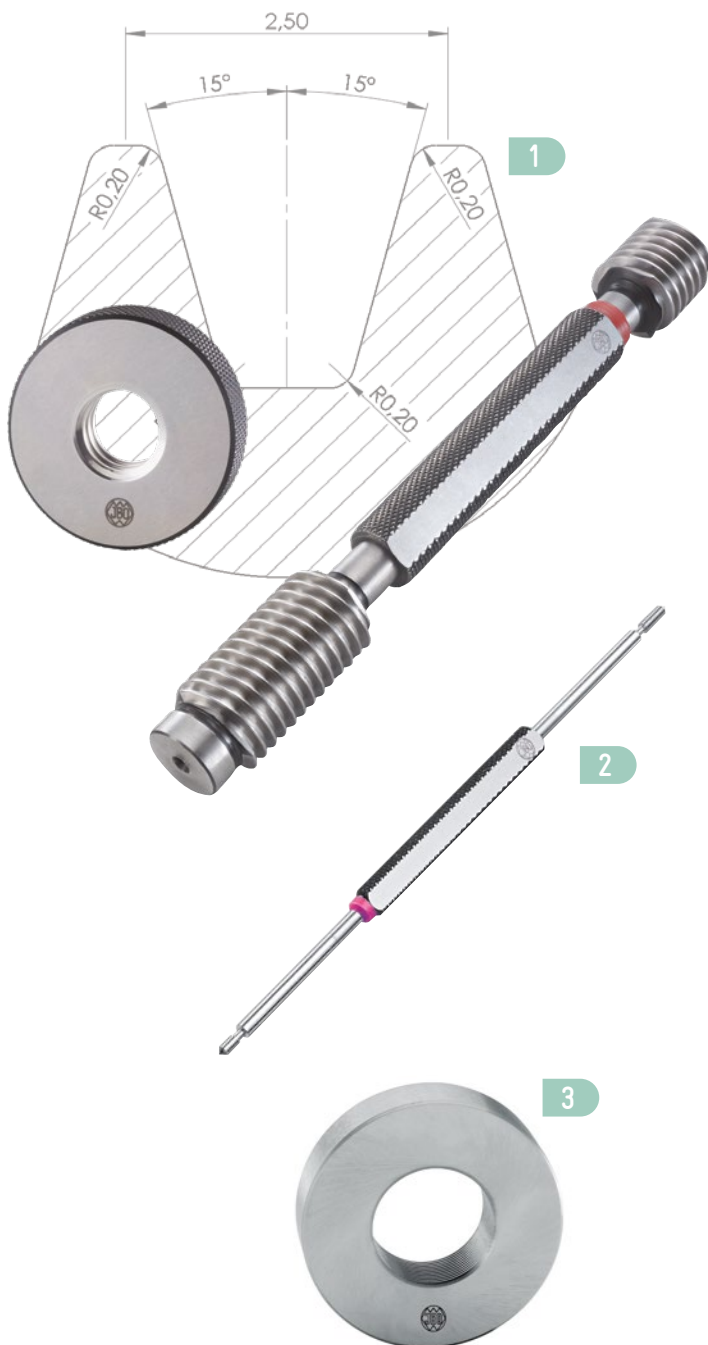

5 Mehrgängiger Gewinde-Gutlehdorn und Gewinde-Gutlehring M 12,5 x 6 P 0,75 - 6g (8-gängig). Höchste Qualität durch geschliffenes Gewinde.

Multiple GO thread plug gauge and GO thread ring gauge M 12.5 x 6 P 0.75 - 6g (8-starts). Maximum quality with ground thread.

6 Der Koordinatenmessdorn dient zur Positionsbestimmung eines Innengewindes mittels 3D Messmaschine. Zur zentrischen Aufnahme ist das Gewinde leicht kegelig ausgeführt. Standardausführung mit Steigungsverzug siehe Seiten 248 und 293.

The coordinate gauge rod determines the position of an internal thread via a 3D measuring machine. The thread is lightly tapered for centric mounting. Standard version with pitch delay see pages 248 and 293.

7 Gewinde-Grenzlehndorn für kundenspezifisches, unsymmetrisches Sondergewinde. Durch das sehr flache Gewindeprofil kann dieses Gewinde konventionell nicht gemessen werden.

GO/NOT GO thread plug gauge for customer-specific, asymmetric special thread. This thread cannot be measured conventionally due to its very flat thread profile.

8 Lehre zur Prüfung des Bohrungs-Ø Kleinmaßes und Konzentrität zum Innengewinde.

Gauge for checking the minimum bore diameter and concentricity of the bore with an internal thread.



Gewindelehren und Prüfaufnahmen nach Zeichnung oder Muster bzw. Auslegung für den speziellen Anwendungsfall des Kunden.

Thread gauges and inspection machine mountings can be made to customer drawings or samples, or can be designed to suit special customer applications.



M
MF
MJ
EG M

G
Rc, R
Pg

UNC
UNF
UN
UNJF

NPT
NPTF



M
MF
M keg.
M taper

G
BSW
BSF
DIN 477
R, BA, Pg

UNC
UNF
UNEF
UN, UNS

NPSM
NPT
NPTF
Tr, Rd



M
MF

G
BSW
BSF
R, Pg
MF-EL

UNC, UNF
UNEF
UN, UNS
UNJC
UNJF

NPT
NPTF
Tr
EG



M
MF
MJ
EG M

G
Rc, R
Pg

UNC
UNF
UN
UNJF

NPT
NPTF



M
MF
M keg.
M taper

G
BSW
BSF
DIN 477
R, BA, Pg

UNC
UNF
UNEF
UN, UNS

NPSM
NPT
NPTF
Tr, Rd



M
MF

G
BSW
BSF
R, Pg
MF-EL

UNC, UNF
UNEF
UN, UNS
UNJC
UNJF

NPT
NPTF
Tr
EG

9 Gewinde-Gutleerring mit DLC-Beschichtung als Verschleißschutz.
GO thread ring gauge with DLC coating provides outstanding wear.

10 Konischer Gewinde-Grenzlehrdorn zur Gewinde- und Koaxialitätsprüfung des Bohrungsdurchmessers zum Gewinde.
Tapered GO/NOT GO thread plug gauge for checking the thread and coaxiality of fit to the thread.

Tapered GO/NOT GO thread plug gauge for checking the thread and coaxiality of fit to the thread.

11 Kegelige Gewinde-Prüfdorn zum Prüfen des kegeligen Gewinde-Lehrringes zur Abnahme und auf Abnutzung.
Tapered thread plug gauge to check the taper thread ring gauge for acceptance and wear.

Tapered thread plug gauge to check the taper thread ring gauge for acceptance and wear.

12 Gewinde-Gutlehdorn zur Gewinde- und Koaxialitätsprüfung von drei Bohrungen zum Gewinde. Die hintere Kante prüft die Mindesteinschraubtiefe.
GO thread plug gauge for checking the thread and coaxiality of three diameters to a thread. The rearward edge shows the minimum length of engagement.

GO thread plug gauge for checking the thread and coaxiality of three diameters to a thread. The rearward edge shows the minimum length of engagement.



Sonderlängen bei Gewinde-Grenzlehrdornen

Special length on GO/NOT GO Thread Plug Gauges

Messlänge

Der Gewinde-Gutlehrdorn ist verlängert, somit ist er einsetzbar für eine Messlänge x . Für die Ausschussteite wird ein Standard-Gewinde-Ausschusslehndorn verwendet. Die Gewindelänge des Gewinde-Gutlehrdorn und des Gewinde-Ausschusslehndorn entspricht dem Standard.

Verwendung

Wird bei überlangen Gewinden im Werkstück benötigt.

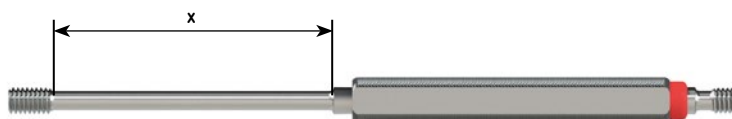
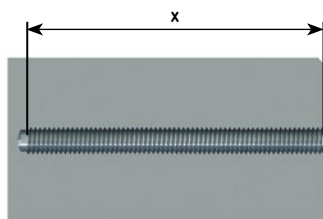

Measuring length

The GO thread plug gauge is extended and therefore suitable for a measuring length x . For the NOT GO side a standard NOT GO thread plug gauge is appropriate. The thread length of the GO thread plug and the NOT GO thread plug is corresponding to the standard.

Application

Required for overlong threads in the workpiece.

Messtiefe

Der Gewinde-Gutlehrdorn und der Gewinde-Ausschusslehndorn sind verlängert, somit sind beide einsetzbar für eine Messtiefe x . Die Gewindelänge des Gewinde-Gutlehrdorn und des Gewinde-Ausschusslehndorn entspricht dem Standard.

Verwendung

Wird für vertieft sitzende Werkstückgewinde benötigt.

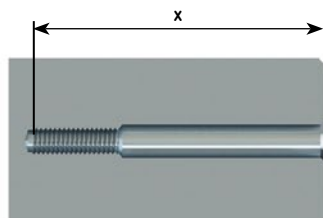

Measuring depth

The GO thread plug gauge and the NOT GO thread plug gauge are extended and therefore both are suitable for a measuring depth x . The thread length of the GO thread plug gauge and the NOT GO thread plug gauge is corresponding to the standard.

Application

Required for recessed threads in the workpiece.

Gewindelänge

Die Gewindelänge des Gewinde-Gutlehrdornes ist verlängert auf die Länge l_2 . Für die Ausschussteite wird ein Standard-Gewinde-Ausschusslehndorn verwendet.

Verwendung

Wird benötigt, wenn z.B. der Steigungsverzug eines langen Werkstückgewindes überprüft werden soll.

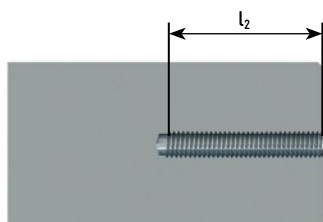

Thread length

The thread length of the GO thread plug gauge is extended on the length l_2 . For the NOT GO side a standard NOT GO thread plug gauge is appropriate.

Application

Required for checking e.g. the pitch delay on a long thread in a workpiece.

- M
MF
MJ
EG M
- G
Rc, R
Pg
- UNC
UNF
UN
UNJF
- NPT
NPTF
- M
MF
M keg.
M taper
- G
BSW
BSF
DIN 477
R, BA, Pg
- UNC
UNF
UNEF
UN, UNS
- NPSM
NPT
NPTF
Tr, Rd
- M
MF
- G
BSW
BSF
R, Pg
MF-EL
- UNC, UNF
UNEF
UN, UNS
UNJC
UNJF
- NPT
NPTF
Tr
EG

Vorteile durch den Einsatz einer MultiCheck

Advantages of using a MultiCheck

- Prüfung der Gewindelehnhaltigkeit und Gewindetiefe mit nur einem Messmittel
- Die Dauer eines Gewindeprüfzyklus wird um 50 % reduziert (eMC 80 %)
- Die messbare Gewindetiefe beträgt 4xD
- Verwendung von leicht modifizierten Standard-Gewindelehrdornen
- Einfacher Austausch von nicht mehr maßhaltigen Lehdornen
- Sichere Ablesung der Gewindetiefe auf Messhülse oder Digitalanzeige
- Gewinde-Gutlehdorn auf Wunsch in beschichteter Ausführung
- One single measuring device for checking both - accuracy to thread size and thread depth
- Thread gauging cycle time reduced by 50 % (eMC 80 %)
- The measurable thread depth is 4xD
- Application of standard thread plug gauges slightly modified
- Simple replacement of worn plug gauges
- Reliable reading of the thread depth from measuring sleeve or digital readout
- GO thread plug gauge with coated finish on request

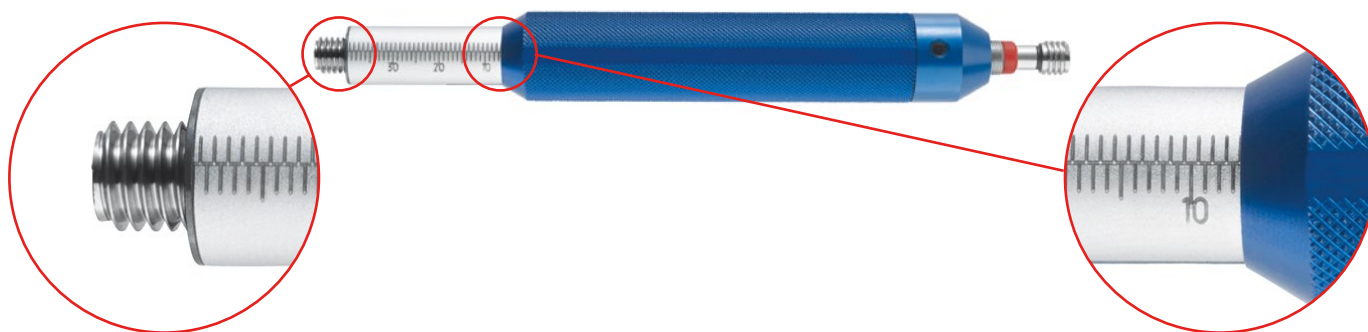

Austausch von Lehdornen

Exchange of thread plug gauges

Wenn Sie den Austausch eines nicht mehr toleranzhaltigen Gewinde-Lehdornes selbst vornehmen wollen, ist ein Abziehset erforderlich, das aus Sechskantmutter, Distanzstück „lang“ für die Gutseite und Distanzstück „kurz“ für die Ausschussteite besteht.

Die mit einer MultiCheck gemessene Gewindetiefe ist die Gewindetiefe des voll ausgebildeten Gewindes und nicht exakt identisch mit der Einschraublänge einer Schraube.

Der Abstand der Planfläche bis zum ersten vollen Gewindeprofil ist $0,5 \times \text{Steigung} \pm 0,02 \text{ mm}$.

Damit wird eine präzise Kalibrierung mit unserer Einstelllehre sichergestellt.

Um Messergebnisse protokollieren zu können, bieten wir für die MultiCheck Digital eine Datenschnittstelle an.

Wir empfehlen zur Kalibrierung unsere Einstelllehre.

If you wish to replace a worn thread plug gauge that is no longer within the specified tolerance yourself, you need a dismantling kit consisting of a draw-off nut, a long spacing sleeve for the „GO“ end and a short spacing sleeve for the „NOT GO“ end.

The MultiCheck measures the length of fully formed thread. This is not exactly identical with the depth to which a screw can be screwed in, due to the distance of the start of the thread from the workpiece face.

The distance from the face to the first complete thread is $0.5 \times \text{pitch} \pm 0.02 \text{ mm}$. This ensures precise calibration with our setting gauge.

For recording measuring results, we offer a data interface for the MultiCheck Digital.

For setting a MultiCheck we recommend our setting gauge.

MCEL

MultiCheck Einstelllehre

- Überprüfung der Nullstellung von MultiCheck-Geräten
- Einstellen der Nullstellung von MultiCheck-Geräten

MultiCheck setting gauge

- Checking the zero position of MultiCheck devices
- Setting the zero position of MultiCheck devices



MultiCheck

MultiCheck

MCS

MultiCheck Skala

- Ablesegenauigkeit 0,5 mm

MultiCheck Scale

- accuracy of reading 0.5 mm



MCN

MultiCheck Nonius

- Ablesegenauigkeit 0,1 mm

MultiCheck Vernier

- accuracy of reading 0.1 mm



MCD

MultiCheck Digital

- Ablesegenauigkeit 0,01 mm

MultiCheck Digital

- accuracy of reading 0.01 mm



MCDW

MultiCheck Digital Wireless

- Digitalanzeige mit integriertem Funk-Modul
- Ablesegenauigkeit 0,01 mm

MultiCheck Digital Wireless

- digital display with integrated wireless module
- accuracy of reading 0.01 mm



WMCD

MultiCheck Digital mit Wechsellehreinsätzen

- Ablesegenauigkeit 0,01 mm

MultiCheck Digital with changeable gauge inserts

- accuracy of reading 0.01 mm



eMC

eMultiCheck

- mit elektronisch geregelttem Antrieb
- Ablesegenauigkeit 0,01 mm
- digitaler Ausgang zur Messwertübertragung

eMultiCheck

- with electronically controlled drive
- accuracy of reading 0.01 mm
- digital output for measured value transmission



eMCW

eMultiCheck Wireless

- mit elektronisch geregelttem Antrieb
- Digitalanzeige mit integriertem Funk-Modul
- Ablesegenauigkeit 0,01 mm

eMultiCheck Wireless

- with electronically controlled drive
- digital display with integrated wireless module
- accuracy of reading 0.01 mm



M
MF
MJ
EG M

G
Rc, R
Pg

UNC
UNF
UN
UNJF

NPT
NPTF

M
MF
M keg.
M taper

G
BSW
BSF
DIN 477
R, BA, Pg

UNC
UNF
UNEF
UN, UNS

NPSM
NPT
NPTF
Tr, Rd

M
MF

G
BSW
BSF
R, Pg
MF-EL

UNC, UNF
UNEF
UN, UNS
UNJC
UNJF

NPT
NPTF
Tr
EG

Kunden-individuelle Sonder-MultiCheck

Special Client-Specific MultiCheck

Wir bieten unsere MultiCheck sowohl für die Prüfung von Gewindebohrungen, als auch für die Prüfung von Passungen und Bohrungen an.
We offer our MultiCheck for the checking of threaded holes as well as for the checking of fits and bores.



Messtation ausgestattet mit MultiCheck
Measuring station equipped with Multi-Check



Kundenspezifischer MultiCheck zur Prüfung der Passung und Messung der Passungstiefe von Bohrungen.
Client-specific MultiCheck plug gauge for checking the fit and measuring the fit depth of bores.

Zusätzliche Adaptionen zum Prüfen mit MultiCheck

Optional adaptors for inspection with MultiCheck



Durchmesservergrößerung für größere Anlageflächen.
Enlarged diameter for large abutment surfaces.



Durchmesserreduzierung für vertiefte Bohrungen.
Reduced diameter for counterbores.

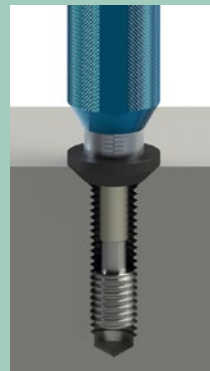

Kegelige Anlagefläche für spezielle Bohrungsansätze.
Conical abutment for special countersinks.



Schräge Anlageflächenhülse für schräge Bohrungen.
Angled abutment sleeve for inclined holes.



Gewindedornverlängerung für sehr tiefe Bohrungen.
Thread plug gauge extension for very deep holes.

Vorteile durch den Einsatz einer eMultiCheck

Advantages of using an eMultiCheck

- Prüfung der Gewindelehnhaltigkeit und Gewindetiefe mit nur einem Messmittel
- Die Dauer eines Gewindeprüfzyklus wird um 80 % reduziert
- Automatisierte Gewindeprüfung mit konstantem Drehmoment unabhängig vom Bediener
- Einfaches Einstellen der unterschiedlichen Parameter wie Drehmoment, Drehrichtung, Prüfung von Sack- oder Durchgangslöcher sowie der Drehzahl
- Sichere Ablesung der Gewindetiefe durch digitale Anzeige
- Die messbare Gewindetiefe beträgt 4xD
- Wechselsysteme für Gewinde-Gutlehrdorn und Messhülse
- Unterstützende Funktion zum Finden des Gewindeanfangs
- Digitaler Ausgang zur Übertragung von Messwerten
- Mit Funkübertragung
- Gewinde-Gutlehrdorn in beschichteter Ausführung
- One single measuring device for checking both – accuracy to thread size and thread depth
- Thread gauging cycle time reduced by 80 %
- Automized thread gauging with constant torque, irrespective of the operator
- Easy setting of the various parameters such as torque, direction of rotation, testing of blind or through holes as well as the speed
- Reliable reading of the thread depth by a digital display
- The measurable thread depth is 4xD
- Changer system for the GO thread plug gauge and the measuring sleeve
- Supporting operation for locating the thread start
- Digital output for transferring the measurement
- With wireless data transmission
- GO thread plug gauge with coated finish



Nach eMultiCheck suchen

Einstellknopf an eMultiCheck sperren

Grundbohrung programmieren

Durchgangsbohrung programmieren

Drehzahl 1 [1/min]

Drehzahl 2 [1/min]

Dauerdrehmodus an aus

Gewindesteigung [mm]

Gewindelänge [mm]

Linksgewinde

Drehmomentstufe 1 - 10 Ncm
empfohlen für Gewindenenn-Ø < 1,6 mm

Drehmomentstufe 2 - 12 Ncm
empfohlen Gewindenenn-Ø ≤ 3,5 mm

Drehmomentstufe 3 - 15 Ncm
empfohlen Gewindenenn-Ø ≤ 5,5 mm

Rechtsgewinde

Drehmomentstufe 4 - 16 Ncm
empfohlen für Gewindenenn-Ø ≤ 8,0 mm

Drehmomentstufe 5 - 17 Ncm
empfohlen für Gewindenenn-Ø ≤ 13,0 mm

Drehmomentstufe 6 - 18 Ncm
empfohlen für Gewindenenn-Ø ≤ 29,0 mm

Einstellungen von eMultiCheck laden

Einstellungen an eMultiCheck senden

Datensatz laden

Datensatz speichern

Alle Datensätze importieren

Alle Datensätze exportieren



Funktionsweise

Mit der eMultiCheck erfolgt die Prüfung automatisch, initiiert durch einen kurzen Knopfdruck. Die Elektronik erkennt das Gewinde und startet den Prüfvorgang durch Eindrehen des Gewinde-Gutlehrdornes mit einem definierten Drehmoment. Dies geschieht ohne die ermüdende Tätigkeit des manuellen Einschraubens der Gutseite des Gewindelehrdornes. Durch Drücken der zweiten Taste wird der Gewinde-Gutlehrdorn wieder aus dem Werkstück heraus gefahren.

Die eMultiCheck ist in zwei verschiedenen Varianten verfügbar, die sich durch einen Netzanschluss oder den Betrieb mit einem integrierten Akku unterscheiden.

Operating mode

With eMultiCheck, testing is initiated automatically via a short press of a button. The electronics recognises the thread and begins the testing procedure by screwing in the GO thread plug gauge according to a defined torque. This occurs without the tiresome manual screwing in of the thread plug gauge's GO side. The GO thread plug gauge is traversed out of the workpiece again by pressing the second push button.

The eMultiCheck is available in two variants, featuring either mains connection or operation via an integral battery.



Anwendung von Gewindelehren

1. Prüfung des zylindrischen Innengewindes mittels eines Gewinde-Grenzlehrdornes

1.1 Anwendung des Gewinde-Gutlehdornes

Ein Gewinde-Gutlehdorn prüft das Paarungsmaß des Innengewindes. Er prüft hierbei die Einhaltung des Mindestmaßes des Flankendurchmessers einschließlich der Steigungsabweichung, Teilflankenabweichungen und Formabweichungen, die eine scheinbare Verkleinerung des Flankendurchmessers des Werkstückgewindes bewirken. Er prüft auch die Einhaltung des Mindestmaßes des Außendurchmessers.

Diese Lehre prüft nicht den Kerndurchmesser des Werkstückes.

Ein Gewinde-Gutlehdorn muss sich von Hand ohne Anwendung besonderer Kraft in die ganze Länge des Werkstückgewindes einschrauben lassen. Ist das Einschrauben nicht möglich, genügt das Werkstückgewinde nicht den Anforderungen.

1.2 Anwendung des Gewinde-Ausschusslehrdornes (mit rotem Ring)

Ein Gewinde-Ausschusslehrdorn prüft, ob der Ist-Flankendurchmesser das vorgeschriebene Höchstmaß überschreitet.

Ein Gewinde-Ausschusslehrdorn darf sich von Hand ohne Anwendung besonderer Kraft in das Werkstückgewinde von beiden Seiten nicht mehr als zwei Umdrehungen einschrauben lassen. Lässt er sich mehr als zwei Umdrehungen einschrauben, genügt das Werkstückgewinde nicht den Anforderungen.

2. Prüfung von zylindrischen Außengewinden mittels eines Gut- und Ausschusslehring

2.1 Anwendung des Gewinde-Gutlehring

Ein Gewinde-Gutlehring prüft das Paarungsmaß des Außengewindes, d.h. er prüft die Einhaltung des Flankendurchmessers einschließlich der Formabweichung und Steigungsabweichung sowie Teilflankenabweichungen, die eine scheinbare Vergrößerung des Werkstückgewindes bewirken. Er prüft auch die Einhaltung des Größtmaßes des Kerndurchmessers. Der Außendurchmesser des Außengewindes wird von dieser Lehre nicht geprüft.

Ein Gewinde-Gutlehring muss sich von Hand ohne Anwendung besonderer Kraft über die ganze Länge des Werkstückgewindes aufschrauben lassen. Ist das Aufschrauben nicht möglich, genügt das Werkstückgewinde nicht den Anforderungen.

2.2 Anwendung des Gewinde-Ausschusslehring (mit roter Markierung)

Ein Gewinde-Ausschusslehring prüft, ob der Ist-Flankendurchmesser des Werkstückes das festgelegte Mindestmaß unterschreitet, also der Flankendurchmesser zu klein ist.

Ein Gewinde-Ausschusslehring darf sich von Hand ohne Anwendung besonderer Kraft auf das Werkstückgewinde nicht mehr als zwei Umdrehungen aufschrauben lassen. Lässt er sich mehr als zwei Umdrehungen aufschrauben, genügt das Werkstückgewinde nicht den Anforderungen.

3. MultiCheck

Diese Lehrdorne mit der Bezeichnung „MultiCheck“ ermöglichen gleichzeitig das Prüfen des Gewindes auf Lehrenhaltigkeit und das Messen der Gewindetiefe bis 4x Gewindedurchmesser. Sonderausführungen sind bis 6xD lieferbar.

Wir bieten 3 Ausführungen an:

Ablesegenauigkeit: MultiCheck Skala: 0,5 mm / MultiCheck Nonius: 0,1 mm / MultiCheck mit Digitalanzeige: 0,01 mm.

Use of Thread Gauges

1. Inspection of parallel internal threads with GO and NOT GO thread plug gauges

1.1 Use of GO thread plug gauge

A GO thread plug gauge checks the virtual size of the internal thread (gauging the virtual pitch diameter). This is effected by checking the minimum limit of the pitch diameter, taking into account pitch errors, errors in flank angles and deviations of form, which produce an apparent reduction of the pitch diameter of the workpiece (virtual pitch diameter). In addition, it checks the minimum limit of the major diameter and also whether the length of straight flank is sufficient; i.e. that the rounding at the root of the profile does not encroach too far upon the flank of the thread.

This gauge does not check the minor diameter of the workpiece thread.

The GO thread plug gauge, when screwed by hand without using excessive force, shall enter the whole length of the workpiece thread. If the entry is not possible, the workpiece thread does not comply with the specification.

1.2 Use of NOT GO thread plug gauge (with red ring)

A NOT GO thread plug gauge checks whether the actual pitch diameter exceeds the specified maximum size.

The NOT GO thread plug gauge, when screwed by hand without using excessive force, may enter into both ends of the threaded part, but by not more than two turns of thread. If it can be screwed in by more than two turns of thread, the workpiece thread does not comply with the specification.

2. Inspection of parallel external threads with GO and NOT GO thread ring gauges

2.1 Use of GO thread ring gauge

A GO thread ring gauge checks the virtual size of the external thread (gauging the virtual pitch diameter); i.e. it checks the maximum material limit of the pitch diameter, taking into account deviations of form and pitch errors and errors in flank angles, which produce an apparent enlargement of the pitch diameter (virtual pitch diameter) of the workpiece. It also checks that the maximum minor diameter has not been exceeded. The major diameter of the external thread is not checked by this gauge.

The GO thread ring gauge, when screwed by hand without using excessive force, shall pass over the whole length of the workpiece thread. If assembly is not possible, the workpiece thread does not comply with the specification.

2.2 Use of NOT GO thread ring gauge (with red spot)

A NOT GO thread ring gauge is intended to check whether the actual pitch diameter of a workpiece exceeds the specified minimum size.

A NOT GO thread ring gauge, when screwed by hand without using excessive force on the workpiece thread, may enter on both sides but by not more than two turns of thread. If the gauge can be screwed onto the workpiece by more than two turns of thread, the thread does not comply with the specification.

3. MultiCheck thread plug gauges

MultiCheck plug gauges enable the thread and its depth up to 4 x thread diameter to be checked simultaneously. Special versions for up to 6xD can be supplied.

Three types of MultiCheck are available with the following reading of accuracy:

MultiCheck Scale: 0.5 mm / MultiCheck Vernier: 0.1 mm / MultiCheck with digital display: 0.01 mm



M
MF
MJ
EG M

G
Rc, R
Pg

UNC
UNF
UN
UNJF

NPT
NPTF



M
MF
M keg.
M taper

G
BSW
BSF
DIN 477
R, BA, Pg

UNC
UNF
UNEF
UN, UNS

NPSM
NPT
NPTF
Tr, Rd



M
MF

G
BSW
BSF
R, Pg
MF-EL

UNC, UNF
UNEF
UN, UNS
UNJC
UNJF

NPT
NPTF
Tr
EG

4. Prüfung von kegeligen Gewinden

Betrifft unter anderem folgende Gewindearten, amerikanisches Rohrgewinde nach ASME B1.20.1 und ANSI B1.20.3 (NPT, NPTF), Rohrgewinde nach DIN EN 10226, ISO 7, DIN 2999, DIN 3858 und BS 21, metrisches kegeliges Gewinde nach DIN 158.

4. Inspection of taper threads

Concerning for example the following thread type, american pipe threads according to ASME B1.20.1 and ANSI B1.20.3 (NPT, NPTF), pipe threads according to DIN EN 10226, ISO 7, DIN 2999, DIN 3858 and BS 21, metric tapered threads according to DIN 158.

Prüfung des Innengewindes

Inspection of internal thread

Prüfung des Aussengewindes

Inspection of external thread

Werkstück Kleinstmaß workpiece minimum size

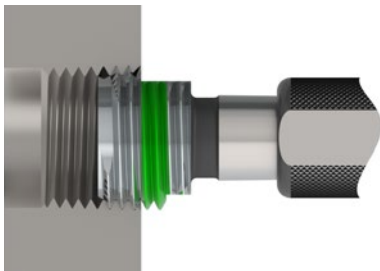

Die Gewindelehre lässt sich bis zum Kleinstmaß-Absatz ein- bzw. aufschrauben. Das Werkstückgewinde ist am Kleinstmaß.

The thread gauge can be screwed (in or on) until the minimum step of thread gauge is reached. The workpiece thread is up to the minimum size.

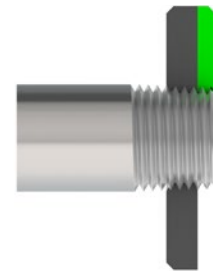

Werkstück innerhalb der Toleranz workpiece in tolerance

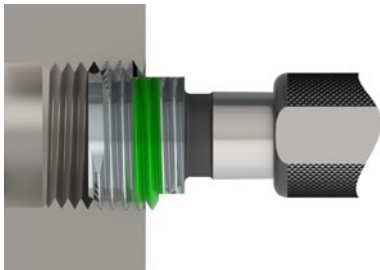

Die Gewindelehre bleibt zwischen den beiden Absätzen stehen. Das Werkstückgewinde ist in Ordnung.

The thread gauge can be screwed (in or on) between the minimum and maximum step of the thread gauge. The workpiece thread is in tolerance.

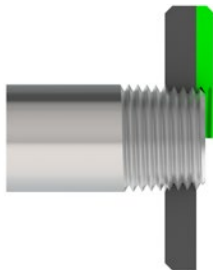

Werkstück Größtmaß workpiece maximum size

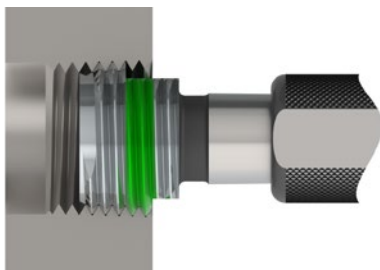

Die Gewindelehre lässt sich bis zum Größtmaß-Absatz ein- bzw. aufschrauben. Das Werkstückgewinde ist am Größtmaß.

Thread gauge can be screwed (in or on) until the maximum step of the thread gauge is reached. The workpiece thread is up to the maximum size.

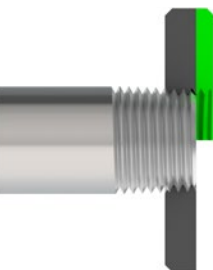

Werkstück ist Ausschuss (zu klein) workpiece is out of tolerance (undersize)

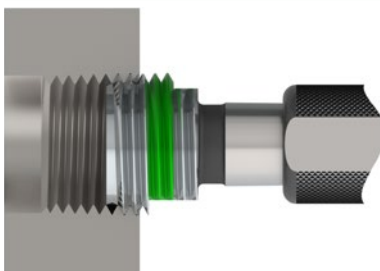

Der Gewinde-Grenzlehndorn lässt sich nicht bis zum Kleinstmaß-Absatz einschrauben, bzw. der Gewinde-Grenzlehherring geht über diesen Absatz hinaus. Das Werkstückgewinde ist zu klein.

The GO/NOT GO thread plug gauge can not be screwed in until the minimum step is reached. The GO/NOT GO thread ring gauge can not be screwed on above the minimum step. The workpiece thread is undersized.

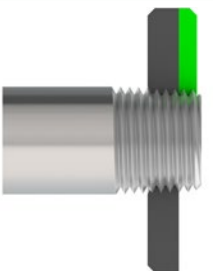

Werkstück ist Ausschuss (zu groß) workpiece is out of tolerance (oversize)

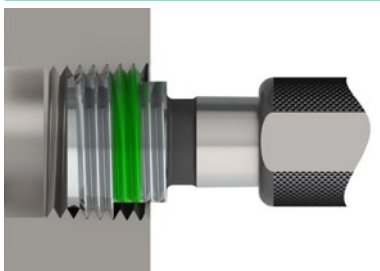

Der Gewinde-Grenzlehndorn lässt sich über den Größtmaß-Absatz hinaus einschrauben, bzw. der Gewinde-Grenzlehherring erreicht diesen Absatz nicht. Das Werkstückgewinde ist zu groß.

The GO/NOT GO thread plug gauge can not be screwed in above the maximum step. The GO/NOT GO thread ring gauge can not be screwed on until the maximum step is reached. The workpiece thread is oversized.

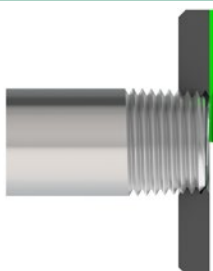

« FAST LINE »



LIEFERUNG INNERHALB 2 WOCHEN
DELIVERY WITHIN 2 WEEKS



Unsere „FAST LINE“ Express-Fertigung ist für Gewindelehrdorne und Gewindelehrringe möglich. Die Lieferung erfolgt innerhalb von 2 Arbeitswochen. Der Expresszuschlag hierfür beträgt € 200,00 pro Auftragsposition.

Bitte kennzeichnen Sie Anfragen und Bestellungen im Betreff mit „FAST LINE“ und richten diese an:

Our "FAST LINE" express production is now possible for thread plug gauges and thread ring gauges. Delivery takes place within 2 working weeks. The express surcharge for this is € 200,00 per order item.

Please mark enquiries and orders in the subject "FAST LINE" and send them to:

fastline@johs-boss.de

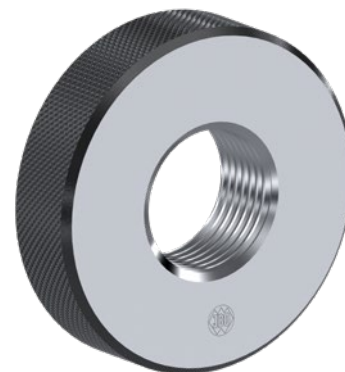

Unser „FAST LINE“ Programm umfasst Gewindelehrdorne und Gewindelehrringe in Sondertoleranzen und Zwischenabmessungen, basierend auf zylindrischen Gewindetypen, die hier im Katalog gelistet sind. Bestellbar sind bis zu 3 Stück pro Artikel im Durchmesser-Bereich von 3 - 100 mm und mit Steigungen von P 0,5 - 4 mm. Ausgenommen davon sind Trapez-Gewinde.

Our "FAST LINE" programme includes thread plug gauges and thread ring gauges in special tolerances and intermediate dimensions, based on cylindrical thread types, which are listed here in the catalogue. Up to 3 pieces are available per article in the diameter range from 3 - 100 mm and with pitches from P 0.5 - 4 mm. Except trapezoidal threads.



M
MF
MJ
EG M

G
Rc, R
Pg

UNC
UNF
UN
UNJF

NPT
NPTF



M
MF
M keg.
M taper

G
BSW
BSF
DIN 477
R, BA, Pg

UNC
UNF
UNEF
UN, UNS

NPSM
NPT
NPTF
Tr, Rd



M
MF

G
BSW
BSF
R, Pg
MF-EL

UNC, UNF
UNEF
UN, UNS
UNJC
UNJF

NPT
NPTF
Tr
EG

Messmaschinen und Messmethoden zur Prüfung und Kalibrierung von Gewindelehren

Measuring machines and measurement process for the testing and calibration of thread gauges

Um die gewohnt hohe Qualität unserer Produkte sicher zu stellen, erfolgt die Prüfung und Kalibrierung der von uns hergestellten Gewindelehren in der Fertigung und im Messlabor, unter Anwendung verschiedener anerkannter Prüf- und Messmethoden.

Die Prüfung und Kalibrierung erfolgt sowohl mittels Gewinde-Prüfdornen, der Dreidraht-/Zweikugelmethode auf Längenkomparatoren der Marken Mahr, Zeiss und Trimos, als auch mit IAC-Gewindescannern. Die IAC-Gewindescanner kommen für erweiterte Kalibrierungen, zur Kalibrierung kegelliger Lehren und zur Ermittlung wichtiger Profilparameter, wie z.B. der Steigung oder dem Flankenwinkel, sowohl in der Fertigung als auch im Messlabor zum Einsatz.

To ensure the high quality of our products, the testing and the calibration of our manufactured thread gauges is carried out with and based on different and approved test and measuring methods, in the production as well as in the measuring laboratory.

The testing and the calibration is carried out with plug check gauges, the three-wire/two-ball method on length comparators of the following brands: Mahr, Zeiss and Trimos as well as with IAC-thread scanners. The IAC-thread scanners are used for extended tests, for the testing and the calibration of tapered gauges and for the determination of important profile parameters, e.g. the pitch or the flank angle, in our production as well as in our measuring laboratory.



JBO-Kalibrierservice für Gewindelehren

JBO calibration service on thread gauges

Unser hauseigenes Kalibrierlabor erfüllt die höchsten Anforderungen an die Messtechnik. Zwei Verfahren zur Kalibrierung von Gewindelehren sind durch die DAkkS akkreditiert. Dies bedeutet, dass die internationalen Normvorgaben für Kalibrierlabore eingeführt, umgesetzt und regelmäßig überwacht werden. Die Vorteile für unsere Kunden liegen auf der Hand, JBO kann DAkkS-Kalibrierscheine zusammen mit lagerhaltigen Gewindelehren in kürzester Zeit liefern. Insbesondere in den Branchen Automotive, Luftfahrt und in dem Bereich Medizin sind sehr häufig DAkkS-Kalibrierscheine gefordert. Der jeweils aktuelle Geltungsbereich (Anlage zur Akkreditierungsurkunde) ist auf unserer Website verlinkt und steht zum Download bereit.

Gerne erstellen wir für Sie Kalibrierscheine mit nationalem und internationalem Logo (DAkkS und ILAC). Des Weiteren bieten wir eine Vielzahl an verschiedenen Werkskalibrierscheinen an. Auch eine Rekalibrierung der Gewindelehren gehört zu unserem Leistungsspektrum. Weiterführende Informationen wie die zugrundeliegenden Richtlinien und den Kalibrierumfang sind auf den folgenden Seiten dokumentiert.

Our in-house calibration laboratory meets the highest requirements for measurement technology. Two procedures for the calibration of thread gauges are accredited by the DAkkS. This means that the international standard specifications for calibration laboratories are introduced, implemented and regularly monitored. The advantages for our customers are obvious, JBO can deliver DAkkS calibration certificates together with stocked thread gauges in the shortest possible time. DAkkS calibration certificates are very often required, especially in the automotive, aviation and medical sectors. The current scope of validity (annex to the accreditation certificate) is linked on our website and is available for download.

We are pleased to issue calibration certificates with national and international logos (DAkkS and ILAC) for you. Furthermore, we offer a variety of different factory calibration certificates. Recalibration of thread gauges is also part of our range of services. Further information such as the underlying guidelines and the scope of calibration are documented on the following pages.

JBO DAkKS-Kalibrierscheine

JBO DAkKS Calibration Certificates



ORDER-CODE ↓	Bezeichnung Designation	Prüfumfang Scope of inspection
Option 1-D	JBO DAkKS-Kalibrierschein Akkreditiert für die Kalibrierung von Gewindelehren nach der Richtlinie VDI/VDE/DGQ 2618 Blatt 4.8/4.9 durch die DAkKS JBO DAkKS calibration certificate Accredited for the calibration of thread gauges according to the guideline VDI/VDE/DGQ 2618 Part 4.8/4.9 by DAkKS	einfacher Flankendurchmesser, ermittelt in zwei Ebenen in jeweils zwei zueinander senkrechten Achsschnitten simple pitch diameter determined in two levels in two axial sections normal to each other
Z1	Preiszuschlag für die Überwachungsprüfung gebrauchter Gewindelehren auf den zuvor gewählten Prüfumfang Price surcharge for the monitoring inspection of used thread gauges on the previously selected inspection scope	
KM	Kalibriermarke für DAkKS-Kalibrierschein Calibration mark for DAkKS calibration certificate	

Messebenen und Achsschnitte

Measuring planes and axial sections

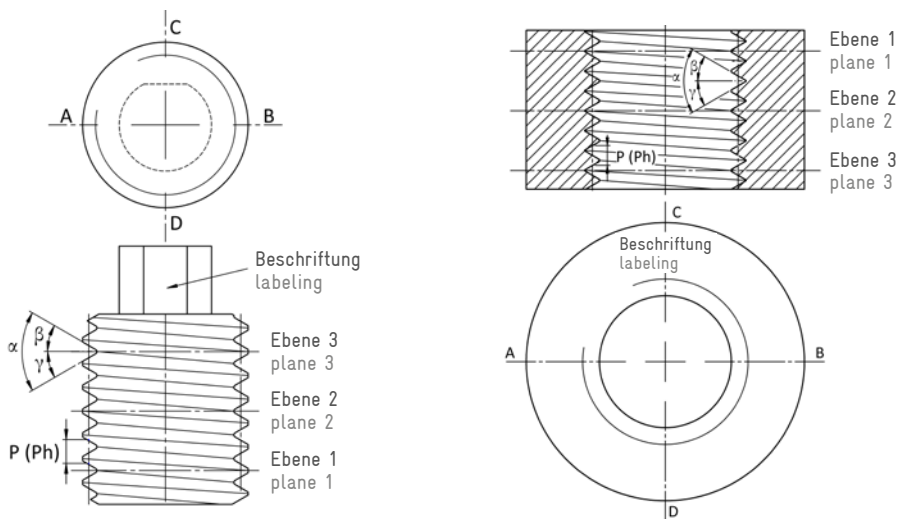

- α = Gewindeprofilwinkel
thread angle
- β = Gewindeflankenwinkel
thread flank angle
- γ = Gewindeflankenwinkel
thread flank angle
- P (Ph) = Teilung (Steigung)
pitch (lead)
- 0° = Achsschnitt A-B
axial section A-B
- 90° = Achsschnitt C-D
axial section C-D

Gewinde-Nenn- \varnothing mm Thread nominal \varnothing mm	P mm	ORDER-CODE ↓	Nettopreise zylindrische Gewinde Net prices parallel threads					
			LD		GD/AD		GR/AR	
			Art.-Nr.	€	Art.-Nr.	€	Art.-Nr.	€
3 - 6	0,5 - 6	Option 1-D	301	32,00	303	26,00	311	38,00
>6 - 40	0,5 - 6	Option 1-D	302	32,00	304	26,00	312	38,00
>40 - 100	0,5 - 6	Option 1-D			305	29,00	313	42,00
		Z1	329	6,00	329	6,00	329	6,00
		KM	294	4,00	294	4,00	294	4,00

Preise sind gültig für im Katalog aufgeführte Gewindearten

Prices are valid for the thread types listed in the catalogue

Preise für Trapez-, Rund-, Sägen-, mehrgängige- und kegelige Gewinde sowie Nenn- \varnothing <3 und >100 mm und weitere Optionen auf Anfrage

Prices for trapezoidal, round, saw, multi-start and tapered threads as well as nominal \varnothing <3 and >100 mm and further options on request

Arten an Werkskalibrierscheinen

Types of Calibration Certificates

ORDER-CODE ↓	Bezeichnung Designation	Prüfumfang Scope of inspection
C5	JBO-Werkskalibrierschein für neue Gewindelehren JBO calibration certificate of new thread gauges	einfacher Flankendurchmesser, ermittelt in einer Ebene simple pitch diameter determined on one level
Option 1	JBO-Werkskalibrierschein nach der Richtlinie VDI/VDE/DGQ 2618 Blatt 4.8/4.9 JBO calibration certificate according to VDI/VDE/DGQ 2618 Part 4.8/4.9	einfacher Flankendurchmesser, ermittelt in zwei Ebenen in jeweils zwei zueinander senkrechten Achsschnitten simple pitch diameter determined on two levels in two axial sections normal to each other
Option 4	JBO-Werkskalibrierschein nach der Richtlinie VDI/VDE/DGQ 2618 Blatt 4.8/4.9 JBO calibration certificate according to VDI/VDE/DGQ 2618 Part 4.8/4.9	wie Option 1 + Messung der Steigung, Messung des Gewindeprofilwinkels und der Gewindeflankenwinkel + Aussendurchmesser bei Gewindelehrdornen bzw. Kerndurchmesser bei Gewindelehrringen as option 1 + the gauging of the pitch and gauging of the thread angle and the flank angles + major-diameter on thread plug gauges, minor-diameter on thread ring gauges
C3	Erweiterter JBO-Werkskalibrierschein zu C5 für neue Gewindelehren Extended JBO calibration certificate to C5 for new thread gauges	wie C5 + Außendurchmesser bei Gewinde-Lehrdornen bzw. Kerndurchmesser bei Gewinde-Lehrringen as C5 + major-diameter on thread plug gauges resp. minor diameter on thread ring gauges
Z1	Preiszuschlag für die Überwachungsprüfung gebrauchter Gewindelehren auf den zuvor gewählten Prüfumfang Price surcharge for the monitoring inspection of used thread gauges on the previously selected inspection scope	

Messebenen und Achsschnitte

Measuring planes and axial sections

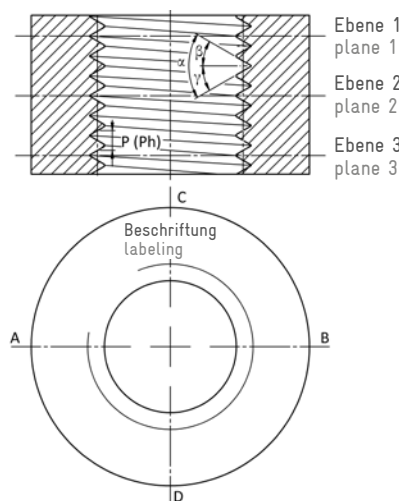
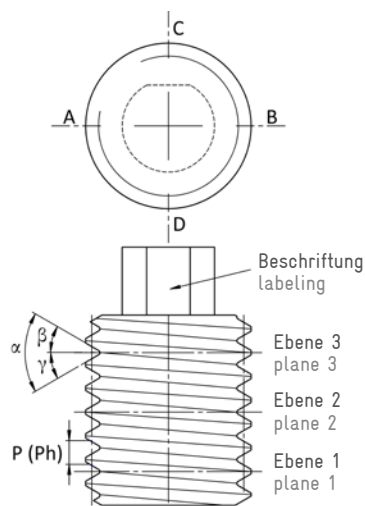

- α = Gewindeprofilwinkel
thread angle
- β = Gewindeflankenwinkel
thread flank angle
- γ = Gewindeflankenwinkel
thread flank angle
- $P (Ph)$ = Teilung (Steigung)
pitch (lead)
- 0° = Achsschnitt A-B
axial section A-B
- 90° = Achsschnitt C-D
axial section C-D

JBO-Werkskalibrierscheine

JBO Calibration Certificates

Gewinde-Nenn-Ø mm Thread nominal Ø mm	ORDER-CODE	Nettopreise Net prices							
		Gewindelehren für zylindrische Gewinde Thread gauges for parallel threads						Gewindelehren für kegelige Gewinde Thread gauges for taper threads	
		LD		GD/AD		GR/AR		LD/LR	
	↓	Art.-Nr.	€	Art.-Nr.	€	Art.-Nr.	€	Art.-Nr.	€
0,5 - <1 unter anderem Gewinde nach DIN 14 amongst others threads according DIN 14	C5	153	35,40						
	Option 1	191	47,80						
	C3	175	42,80						
1 - <3 GR/AR ⁽¹⁾	C5	154	16,50	155	12,80	156	18,20		
	Option 1	192	21,80	193	16,70	auf Anfrage on request			
	C3	176	20,00	177	15,50				
3 - 6 GR/AR ⁽¹⁾ Lehren mit Steigung <0,5 mm Option 4 nicht möglich Gauges with pitch <0.5 mm Option 4 not available	C5	157	12,90	158	10,00	159	14,60		
	Option 1	194	17,10	195	13,00	196	19,30		
	Option 4	229	28,20	507	22,00	508	21,00		
	C3	178	16,10	179	12,40	180	16,20		
>6 - 40 GR/AR ⁽¹⁾ Lehren mit Steigung <0,5 mm Option 4 nicht möglich Gauges with pitch <0.5 mm Option 4 not available	C5	160	11,30	161	9,00	174	12,90	162	22,50
	Option 1	197	15,50	198	11,70	198	17,10		
	Option 4	222	28,20	223	22,00	224	21,00		
	C3	181	14,30	182	11,20	183	14,60	184	24,00 ⁽²⁾
>40 - 100 GR/AR ⁽¹⁾ Lehren mit Steigung <0,5 mm Option 4 nicht möglich Gauges with pitch <0.5 mm Option 4 not available	C5			163	10,70	164	16,00	165	27,00
	Option 1			202	13,30	203	21,20		
	Option 4			225	23,10	226	24,80		
	C3			185	12,40	186	17,70	200	29,00 ⁽²⁾
>100 - 200 GR/AR Lehren mit Steigung <0,5 mm Option 4 nicht möglich Gauges with pitch <0.5 mm Option 4 not available	C5			166	15,00	167	19,50	168	33,00
	Option 1			204	21,20	205	24,80		
	Option 4			227	28,30	228	30,10		
	C3			187	17,80	188	21,20	201	35,00 ⁽²⁾
>200 - 300 GR/AR Lehren mit Steigung <0,5 mm Option 4 nicht möglich Gauges with pitch <0.5 mm Option 4 not available	C5			169	27,40	173	32,20	auf Anfrage on request	
	Option 1			206	37,00	207	38,60		
	Option 4			509	42,30	510	45,00		
	C3			189	30,60	190	35,40	auf Anfrage on request	
	Z1		6,00	329	6,00	329	6,00	329	6,00

Preise sind gültig für im Katalog aufgeführte Gewindearten, alle anderen und mehrgängige Gewinde auf Anfrage

The prices are valid for the thread types listed in the catalogue, other threads and multi-start threads on request

Für Trapezgewinde berechnen wir 50 % Zuschlag

For trapezoidal threads we charge 50 % surcharge

(1) Bei kleinen Nenndurchmessern oder bei Steigungen <0,35 mm, wird eine Prüfung mit Prüfdornen durchgeführt. Es wird ein C5 Werkskalibrierschein erstellt.

(1) For small nominal diameters or pitches <0.35 mm, a test with test mandrels is carried out. In these cases, a C5 factory calibration certificate is issued.

(2) Bei Gewinde-Grenzlehrringen der Gewindeart R, wird eine Prüfung mit Prüfdornen durchgeführt. Es wird ein C5 Werkskalibrierschein erstellt.

(2) For thread limit ring gauges of thread type R, a test is carried out with test mandrels. In these cases, a C5 works calibration certificate is issued.



Präzisions-Gewindelehren

Metrisches ISO-Gewinde DIN 13

Lehrenmaße nach DIN ISO 1502

Precision thread gauges

ISO metric thread DIN 13

Gauge dimensions acc. DIN ISO 1502



LD

LD-DLC

M

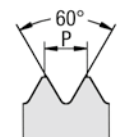

ORDER-CODE →		LD	LD-6G	LD-4H	LD-DLC	LD-6G-DLC	LD-LH	LD-6G-LH
d	P mm	6H Grenzlehndorn Plug gauge ≤ M 0,9 Tol. 4H DIN 14 M 1-M 1,4 Tol. 5H	6G Grenzlehndorn Plug gauge	4H Grenzlehndorn Plug gauge	6H Grenzlehndorn GD: DLC-Härte HV 0,05 > 5000 Plug gauge GO: DLC hardness HV 0.05 > 5000	6G Grenzlehndorn GD: DLC-Härte HV 0,05 > 5000 Plug gauge GO: DLC hardness HV 0.05 > 5000	6H links Grenzlehndorn left hand Plug gauge ≤ M 1,4 Tol. 5H	6G links Grenzlehndorn left hand Plug gauge
↓								
		Art.-Nr. €	Art.-Nr. €	Art.-Nr. €	Art.-Nr. €	Art.-Nr. €	Art.-Nr. €	Art.-Nr. €
M 0,5	0,125	524336 ○						
M 0,6	0,15	527515 ○						
M 0,7	0,175	527516 ○						
M 0,8	0,2	524340 ○						
M 0,9	0,225	527517 ○						
M 1*	0,25	511618 129,00		517091 162,00			517151 166,00	
M 1,1*	0,25	511621 148,00		517158 ○			517152 196,00	
M 1,2*	0,25	511623 108,00		511624 136,00			514484 136,00	
M 1,4*	0,3	511629 87,00		511630 110,00			514485 115,00	
M 1,6	0,35	511636 80,20	511639 96,30	511637 101,00	514136 102,00		513913 106,00	
M 1,7	0,35	511642 91,30						
M 1,8	0,35	511644 73,70	511645 90,20	514527 92,90			517011 102,00	
M 2	0,4	511859 65,10	511862 72,70	511860 83,30	513460 85,90		511867 84,90	
M 2,2	0,45	511873 70,30	511876 92,70	511874 93,20			514486 97,60	
M 2,3	0,4	511879 72,70						
M 2,5	0,45	511883 56,30	511886 62,90	511884 72,00	512756 76,20	512757 87,60	511888 75,60	
M 2,6	0,45	511894 70,60	511897 ○					
M 3	0,5	512036 47,10	512043 53,30	512039 60,80	512777 66,10	512778 76,00	512049 62,00	514584 ○
M 3,5	0,6	512059 49,50	512064 54,50	512060 63,70			512066 65,50	
M 4	0,7	512177 44,30	512182 50,20	512179 57,20	512788 63,40	512789 72,90	512186 57,20	512187 ○
M 4,5	0,75	512202 61,20	512203 76,90	514587 ○			512204 80,90	
M 5	0,8	512218 43,20	512225 49,00	512221 55,80	512792 64,50	512793 74,20	512231 55,80	512232 63,70
M 6	1	512252 41,80	512259 49,80	512256 54,10	512796 63,00	512797 72,40	512268 54,10	512269 61,50
M 7	1	512286 46,30	512288 50,90	512287 58,20	512800 74,50		512290 58,20	516976 ○
M 8	1,25	512305 43,20	512311 49,00	512307 55,80	512801 68,40	512802 78,80	512318 55,80	512319 63,70
M 9	1,25	512345 57,60	512347 70,50	512346 ○			512959 76,10	
M 10	1,5	511646 46,40	511650 52,50	511648 60,00	512731 73,50	512732 84,50	511654 60,00	511655 68,20
M 11	1,5	511679 61,40	511680 77,40	514214 ○			514583 79,00	
M 12	1,75	511689 50,40	511693 55,90	511691 65,30	512737 78,20	512738 89,80	511697 64,10	511698 74,30

* Toleranz 6H auf Anfrage

○ am Lager, Preis auf Anfrage

* tolerance 6H on request

○ in stock, price on request

Präzisions-Gewindelehren Metrisches ISO-Gewinde DIN 13

Lehrenmaße nach DIN ISO 1502

Precision thread gauges
ISO metric thread DIN 13
Gauge dimensions acc. DIN ISO 1502

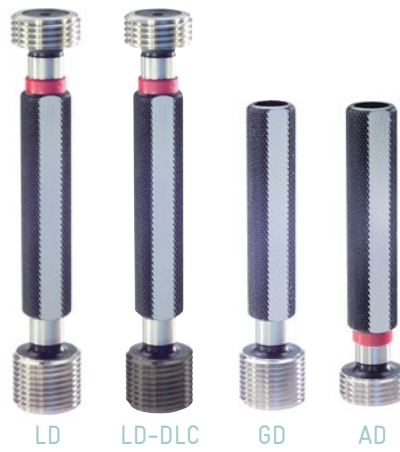

ORDER-CODE →		LD	LD-6G	LD-4H	LD-DLC	LD-6G-DLC	LD-LH	LD-6G-LH
d	P mm	6H Grenzlehrdorn Plug gauge	6G Grenzlehrdorn Plug gauge	4H Grenzlehrdorn Plug gauge	6H Grenzlehrdorn GD: DLC-Härte HV 0,05 > 5000 Plug gauge GO: DLC hardness HV 0.05 > 5000	6G Grenzlehrdorn GD: DLC-Härte HV 0,05 > 5000 Plug gauge GO: DLC hardness HV 0.05 > 5000	6H links Grenzlehrdorn left hand Plug gauge	6G links Grenzlehrdorn left hand Plug gauge
↓								
		Art.-Nr. €	Art.-Nr. €	Art.-Nr. €	Art.-Nr. €	Art.-Nr. €	Art.-Nr. €	Art.-Nr. €
M 14	2	511730 54,30	511733 60,30	511732 72,40	512744 89,20		511735 69,00	514055 ○
M 16	2	511776 58,10	511780 64,60	511778 77,70	512749 93,50	516828 107,00	511784 73,90	514056 88,20
M 18	2,5	511820 63,00	511822 80,20	511821 84,10			511823 80,10	511824 ○
M 20	2,5	511902 67,60	511904 81,80	516781 90,30	512758 114,00		511908 86,00	513902 112,00
M 22	2,5	511934 71,50	511935 88,30				511938 91,00	
M 24	3	511965 80,60	511966 97,60				511969 103,00	516995 133,00
M 27	3	512005 90,50	512006 111,00				512007 114,00	517816 ○
M 30	3,5	512075 100,00	512076 120,00				512077 126,00	513995 164,00
M 33	3,5	512108 111,00	512109 136,00				514298 142,00	
M 36	4	512144 120,00	512145 144,00				512146 151,00	
M 39	4	512166 132,00	512167 162,00				514299 183,00	

ORDER-CODE →		GD	AD	GD-LH	AD-LH	
d	P mm	6H Gutlehrdorn GO plug gauge	6H Ausschusslehrdorn NOT GO plug gauge	6H links Gutlehrdorn left hand GO plug gauge	6H links Ausschusslehrdorn left hand NOT GO plug gauge	
↓						
		Art.-Nr. €	Art.-Nr. €	Art.-Nr. €	Art.-Nr. €	
M 42	4,5	511110 87,40	510383 78,20	514598 110,00	514600 98,60	
M 45	4,5	511122 93,90	510395 84,80	513679 118,00	516961 107,00	
M 48	5	511136 101,00	510408 91,50	511137 127,00	510409 115,00	
M 52	5	511174 108,00	510444 98,00	514599 136,00	517178 124,00	
M 56	5,5	511187 120,00	510457 108,00			
M 60	5,5	511211 134,00	510482 122,00			
M 64	6	511218 148,00	510492 134,00			
M 68	6	513504 157,00	513505 142,00			

○ am Lager, Preis auf Anfrage

○ in stock, price on request



Präzisions-Gewindelehren

Metrisches ISO-Gewinde DIN 13

Lehrenmaße nach DIN ISO 1502

Precision thread gauges

ISO metric thread DIN 13

Gauge dimensions acc. DIN ISO 1502

M

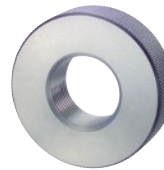
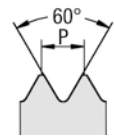

GR

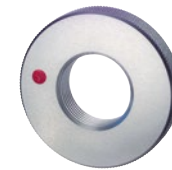

AR



ORDER-CODE →		GR	AR	GR-6e	AR-6e	GR-6h	AR-6h				
d	P mm	6g Gutlehring GO ring gauge ≤ M 1,4 Tol. 6h 	6g Ausschusslehring NOT GO ring gauge ≤ M 1,4 Tol. 6h 	6e Gutlehring GO ring gauge 	6e Ausschusslehring NOT GO ring gauge 	6h Gutlehring GO ring gauge 	6h Ausschusslehring NOT GO ring gauge 				
		Art.-Nr.	€	Art.-Nr.	€	Art.-Nr.	€	Art.-Nr.	€	Art.-Nr.	€
M 1*	0,25	501426	107,00	500131	107,00						
M 1,1*	0,25	501430	138,00	500135	138,00						
M 1,2*	0,25	501431	99,90	500136	99,90						
M 1,4*	0,3	501434	89,30	500139	89,30						
M 1,6	0,35	501441	77,20	500146	77,20	501443	91,40	500148	91,40	501444	97,30
M 1,7	0,35	501446	94,30	500151	94,30						
M 1,8	0,35	501448	68,90	500154	68,90	504215	○	520148	○	501450	97,30
M 2	0,4	501700	65,20	500404	65,20	501704	74,90	500409	74,90	501705	82,10
M 2,2	0,45	501714	72,70	500419	72,70	501715	83,60	500420	83,60	506050	91,70
M 2,3	0,4	501720	120,00	500425	120,00						
M 2,5	0,45	501724	52,80	500429	52,80	501728	59,50	500432	59,50	501729	64,50
M 2,6	0,45	501739	64,80	500441	64,80					501743	○
M 3	0,5	501903	40,70	500596	40,70	501906	45,90	500600	45,90	501908	49,70
M 3,5	0,6	501919	42,80	500611	42,80	501921	46,80	500613	46,80	501923	51,40
M 4	0,7	502047	37,10	500734	37,10	502051	41,80	500736	41,80	502052	45,90
M 4,5	0,75	502069	57,80	500752	57,80	502071	○	500754	○	503374	○
M 5	0,8	502138	37,10	500822	37,10	502143	41,80	500826	41,80	502145	45,90
M 6	1	502214	37,10	500896	37,10	502218	41,80	500900	41,80	502220	45,90
M 7	1	502271	42,50	500948	42,50	502272	48,90	500949	48,90	502273	53,40
M 8	1,25	502301	38,10	500980	38,10	502305	42,90	500984	42,90	502306	47,10
M 9	1,25	502347	50,80	501024	50,80	502956	64,10	502957	64,10	502349	64,10
M 10	1,5	501452	42,50	500158	42,50	501456	49,40	500162	49,40	501457	54,10
M 11	1,5	501492	59,60	500201	59,60	501494	75,10	500202	75,10	501495	75,10
M 12	1,75	501512	47,40	500218	47,40	501517	54,80	500221	54,80	501518	60,20
M 14	2	501572	50,60	500277	50,60	501574	60,90	500279	60,90	501575	64,30
M 16	2	501623	57,90	500327	57,90	501626	65,20	500331	65,20	501627	71,40
M 18	2,5	501663	68,50	500370	68,50	501664	75,60	500371	75,60	501665	82,90
M 20	2,5	501748	74,10	500447	74,10	501751	83,50	500452	83,50	501752	91,60
M 22	2,5	501782	83,20	500479	83,20	501783	101,00	500480	101,00	501784	101,00
M 24	3	501815	87,30	500508	87,30	501817	108,00	500511	108,00	501818	108,00
M 27	3	501868	99,90	500559	99,90	501869	120,00	500560	120,00	501870	120,00

* Toleranz 6g auf Anfrage

○ am Lager, Preis auf Anfrage

* tolerance 6g on request

○ in stock, price on request



Präzisions-Gewindelehren

Metrisches ISO-Gewinde DIN 13

Lehrenmaße nach DIN ISO 1502

Precision thread gauges

ISO metric thread DIN 13

Gauge dimensions acc. DIN ISO 1502

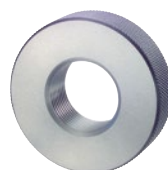

GR

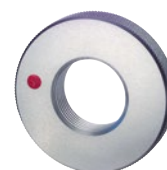

AR



ORDER-CODE →		GR-4h		AR-4h		GR-LH		AR-LH		GR-6e-LH		AR-6e-LH	
d	P mm	4h Gutlehring GO ring gauge		4h Ausschusslehring NOT GO ring gauge		6g links Gutlehring left hand GO ring gauge		6g links Ausschusslehring left hand NOT GO ring gauge		6e links Gutlehring left hand GO ring gauge		6e links Ausschusslehring left hand NOT GO ring gauge	
↓													
		Art.-Nr.	€	Art.-Nr.	€	Art.-Nr.	€	Art.-Nr.	€	Art.-Nr.	€	Art.-Nr.	€
M 1	0,25	501427	397,00	500132	397,00	506035	○	506028	○				
M 1,1	0,25	506034	506,00	506046	506,00	506036	○	506029	○				
M 1,2	0,25	501432	365,00	500137	365,00	506037	○	506030	○				
M 1,4	0,3	501435	113,00	500140	113,00	506038	127,00	506031	127,00				
M 1,6	0,35	501442	97,30	500147	97,30	505880	110,00	505436	110,00				
M 1,7	0,35												
M 1,8	0,35	501449	86,80	500155	86,80	506040	○	506033	○				
M 2	0,4	501702	82,10	500407	82,10	501707	99,30	502739	99,30				
M 2,2	0,45	503906	91,70	503923	91,70	506045	○	505461	○				
M 2,3	0,4												
M 2,5	0,45	501726	64,50	500430	64,50	501730	73,90	500434	73,90				
M 2,6	0,45												
M 3	0,5	501905	49,70	500598	49,70	501910	49,70	500604	49,70				
M 3,5	0,6	501920	51,40	500612	51,40	501924	51,40	500615	51,40				
M 4	0,7	502049	45,90	500735	45,90	502053	45,90	500739	45,90	503914	54,30	503918	54,30
M 4,5	0,75	502070	○	500753	○	502072	○	500756	○				
M 5	0,8	502141	45,90	500824	45,90	502147	45,90	500831	45,90	502954	54,30	502955	54,30
M 6	1	502217	45,90	500899	45,90	502222	45,90	500904	45,90	502224	54,30	500905	54,30
M 7	1	502915	53,40	502914	53,40	502274	53,40	500951	53,40				
M 8	1,25	502304	47,10	500983	47,10	502308	47,10	500989	47,10	502309	55,70	500990	55,70
M 9	1,25	502348	64,10	501025	64,10	502800	64,10	502801	64,10				
M 10	1,5	501455	54,10	500161	54,10	501459	54,10	500167	54,10	503093	64,20	503094	64,20
M 11	1,5	501493	75,10	503125	75,10	503911	75,10	503904	75,10				
M 12	1,75	501515	60,20	500220	60,20	501520	60,20	500227	60,20	503759	71,30	503760	71,30
M 14	2	503905	64,30	503920	64,30	501576	73,30	500281	73,30	505585	○	500282	○
M 16	2	501625	71,40	500330	71,40	501628	71,40	500334	71,40	503643	84,70	500335	84,70
M 18	2,5	503907	82,90	503921	82,90	501666	82,90	500373	82,90				
M 20	2,5	501750	91,60	500450	91,60	501753	91,60	500454	91,60	503915	108,00	503919	108,00
M 22	2,5	503879	103,00	503922	103,00	501786	101,00	503353	101,00				
M 24	3	503588	108,00	500510	108,00	501819	108,00	500514	108,00				
M 27	3	503908	113,00	506047	113,00	501871	120,00	500562	120,00				

○ am Lager, Preis auf Anfrage

○ in stock, price on request



M
MF
MJ
EG M

G
Rc, R
Pg

UNC
UNF
UN
UNJF

NPT
NPTF

M
MF
M keg.
M taper

G
BSW
BSF
DIN 477
R, BA, Pg

UNC
UNF
UNEF
UN, UNS

NPSM
NPT
NPTF
Tr, Rd

M
MF

G
BSW
BSF
R, Pg
MF-EL

UNC, UNF
UNEF
UN, UNS
UNJC
UNJF

NPT
NPTF
Tr
EG

Präzisions-Gewindelehren

Metrisches ISO-Gewinde DIN 13

Lehrenmaße nach DIN ISO 1502

Precision thread gauges

ISO metric thread DIN 13

Gauge dimensions acc. DIN ISO 1502

M

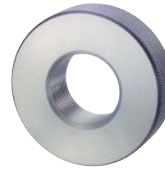
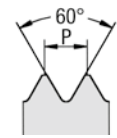

GR

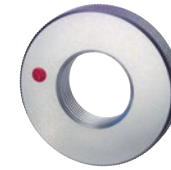

AR



ORDER-CODE →		GR	AR	GR-6e	AR-6e	GR-6h	AR-6h	
d	P mm	6g Gutlehring GO ring gauge	6g Ausschusslehring NOT GO ring gauge	6e Gutlehring GO ring gauge	6e Ausschusslehring NOT GO ring gauge	6h Gutlehring GO ring gauge	6h Ausschusslehring NOT GO ring gauge	
↓								
		Art.-Nr. €	Art.-Nr. €	Art.-Nr. €	Art.-Nr. €	Art.-Nr. €	Art.-Nr. €	
M 30	3,5	501929 107,00	500623 107,00	501931 131,00	500625 131,00	501932 131,00	500626 131,00	
M 33	3,5	501975 120,00	500664 120,00	504575 147,00	505324 147,00	503924 144,00	503925 144,00	
M 36	4	502011 127,00	500696 127,00	503038 155,00	540008 155,00	502012 155,00	500697 155,00	
M 39	4	502039 141,00	500723 141,00	518837 169,00	540862 169,00	503893 169,00	506052 169,00	
M 42	4,5	502093 146,00	500775 146,00			503932 223,00	506061 223,00	
M 45	4,5	502108 154,00	500791 154,00			506059 235,00	506062 235,00	
M 48	5	502125 163,00	500807 163,00			505775 250,00	505776 250,00	
M 52	5	502176 195,00	500860 195,00			506060 268,00	506063 268,00	
M 56	5,5	502199 187,00	500877 187,00					
M 60	5,5	502244 250,00	500923 250,00					
M 64	6	502257 265,00	500935 265,00					
M 68	6	502267 283,00	500944 283,00					

Präzisions-Gewindelehren

Metrisches ISO-Gewinde DIN 13

Lehrenmaße nach DIN ISO 1502

Precision thread gauges

ISO metric thread DIN 13

Gauge dimensions acc. DIN ISO 1502

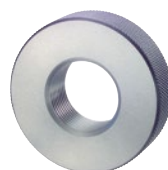

GR

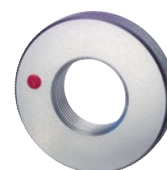

AR



ORDER-CODE →		GR-4h	AR-4h	GR-LH	AR-LH	GR-6e-LH	AR-6e-LH		
d	P mm	4h Gutlehring GO ring gauge	4h Ausschusslehring NOT GO ring gauge	6g links Gutlehring GO ring gauge	6g links Ausschusslehring NOT GO ring gauge	6e links Gutlehring GO ring gauge	6e links Ausschusslehring NOT GO ring gauge		
↓									
		Art.-Nr.	€	Art.-Nr.	€	Art.-Nr.	€	Art.-Nr.	€
M 30	3,5	501930	134,00	500624	134,00	501933	131,00	500627	131,00
M 33	3,5					501976	144,00	500665	144,00
M 36	4					502013	155,00	500698	155,00
M 39	4					502987	179,00	502988	179,00
M 42	4,5					503533	195,00	503933	195,00
M 45	4,5					503327	205,00	505825	205,00
M 48	5					503534	219,00	503726	219,00
M 52	5					503535	235,00	506064	235,00
M 56	5,5								
M 60	5,5								
M 64	6								
M 68	6								

M
MF
MJ
EG M

G
Rc, R
Pg

UNC
UNF
UN
UNJF

NPT
NPTF

M
MF
M keg.
M taper

G
BSW
BSF
DIN 477
R, BA, Pg

UNC
UNF
UNEF
UN, UNS

NPSM
NPT
NPTF
Tr, Rd

M
MF

G
BSW
BSF
R, Pg
MF-EL

UNC, UNF
UNEF
UN, UNS
UNJC
UNJF

NPT
NPTF
Tr
EG



M
MF
MJ
EG M

G
Rc, R
Pg

UNC
UNF
UN
UNJF

NPT
NPTF

M
MF
M keg.
M taper

G
BSW
BSF
DIN 477
R, BA, Pg

UNC
UNF
UNEF
UN, UNS

NPSM
NPT
NPTF
Tr, Rd

M
MF

G
BSW
BSF
R, Pg
MF-EL

UNC, UNF
UNEF
UN, UNS
UNJC
UNJF

NPT
NPTF
Tr
EG

Präzisions-Gewindelehren MultiCheck

Metrisches ISO-Gewinde DIN 13

Lehrenmaße nach DIN ISO 1502
Messtiefe bis 4 x D, max. 80 mm

Precision thread gauges MultiCheck
ISO metric thread DIN 13
Gauge dimensions acc.
DIN ISO 1502
Gauging depth up to 4 x D,
max. 80 mm



Nonius/Vernier

Skala/Scale

Digital/Digital readout



ORDER-CODE →			MCS	MCN			MCD		
Ablesegenauigkeit Accuracy of reading			0,5 mm		0,1 mm			0,01 mm	
d	P mm	System- größe System size	Skala 6H Scale		Nonius 6H Vernier		System- größe System size	Digital 6H inkl. Prüfzert. Digital readout incl. inspection certificate	
↓									
			Art.-Nr.	€	Art.-Nr.	€		Art.-Nr.	€
M 2	0,4	15	590035	293,00	590242	426,00	28	590137	699,00
M 2,5	0,45	15	590069	284,00	590243	404,00	28	590138	690,00
M 3	0,5	15	590005	276,00	590244	396,00	28	590119	681,00
M 3,5	0,6	15	590070	xx	590245	xx	28	590139	xx
M 4	0,7	15	590006	271,00	590246	389,00	28	590117	686,00
M 5	0,8	15	590007	265,00	590247	378,00	28	590140	676,00
M 6	1	15	590000	247,00	590234	366,00	28	590114	666,00
M 7	1	20	590071	328,00	590248	440,00	28	590115	714,00
M 8	1,25	20	590001	293,00	590249	409,00	28	590116	705,00
M 10	1,5	20	590002	297,00	590251	412,00	28	590118	709,00
M 12	1,75	25	590003	317,00	590253	442,00	35	590121	846,00
M 14	2	25	590014	320,00	590254	445,00	35	590144	857,00
M 16	2	28	590015	386,00	590255	525,00	35	590145	885,00
M 18	2,5	28	590074	391,00	590256	530,00	35	590146	897,00
M 20	2,5	36	590017	xx	590257	xx	35	590147	xx
M 22	2,5	36	590075	xx	590258	xx	35	590148	xx
M 24	3	36	590076	xx	590259	xx	35	590149	xx
M 27	3	43	590077	xx	590260	xx	35	590150	xx
M 30	3,5	43	590078	xx	590261	xx	35	590151	xx

xx Preis auf Anfrage

Preise für Gutseite DLC beschichtet auf Anfrage

MultiCheck Einstelllehre € 263,- (Art.-Nr. 592010)

Abb. siehe Seite 228

Abziehset für Gewinde

Ø 2-24 € 132,-

Datenübertragung auf Anfrage

MultiCheck Digital mit integriertem Funk-Modul (MCDW)
auf Anfrage

xx price on request

Prices for GO side DLC coated on request

MultiCheck setting gauge € 263,- (article no. 592010)

see figure page 228

dismantling kit for threads

Ø 2-24 € 132,-

Data transfer on request

MultiCheck digital with integrated wireless data transmission
(MCDW) on request



Präzisions-Gewindelehren MultiCheck Digital mit Wechsellehreinsätzen

Metrisches ISO-Gewinde DIN 13

Lehrenmaße nach DIN ISO 1502

Messtiefe bis 4 x D, max. 80 mm

Ausführung: Grundgerät MultiCheck Digital mit Wechsellehreinsätzen, Messhülse, Schutzhülse, Ablesegenauigkeit 0,01 mm

Anwendung: Prüfung der Lehrenhaltigkeit und die Messung der Gewindetiefen

Precision thread gauges MultiCheck Digital with changeable gauge inserts

ISO metric thread DIN 13

Gauge dimensions acc. DIN ISO 1502

Gauging depth up to 4 x D, max. 80 mm

Specification: basic device MultiCheck Digital with changeable gauge inserts, measuring sleeve, interchangeable gauge inserts, protective sleeve reading accuracy 0.01mm

Usage: checking of the gauge accuracy and measurement of the thread depths



ORDER-CODE →		WMCD	WMH	WGD	WSH	AD				
d	P mm	Systemgröße System size	Grundgerät inkl. Prüfzert. basic unit incl. inspection certificate	Messhülse inkl. Prüfzert. measuring sleeve incl. inspection certificate	Wechsel- gewindelehre inkl. Prüfzert. changeable thread gauge incl. inspection certificate	Schutzhülse inkl. Prüfzert. protective sleeve incl. inspection certificate	Ausschuss- lehndorn inkl. Prüfzert. NOT GO plug gauge incl. inspection certificate			
↓										
			Art.-Nr. €	Art.-Nr. €	Art.-Nr. €	Art.-Nr. €	Art.-Nr. €			
M 2	0,45	28	229743 708,00	229747 82,30	232694 291,00	232697 112,00	510191 39,60			
M 3	0,5				232693 273,00	232696 112,00	510289 28,70			
M 4	0,7				232692 270,00	232695 112,00	510358 27,00			
M 5	0,8				229750 224,00	229759 79,00	510419 26,30			
M 6	1				229751 213,00	229760 79,00	510469 25,40			
M 8	1,25				229752 214,00	229761 83,40	510519 26,30			
M 10	1,5				229753 217,00	229762 83,40	510067 28,20			
M 12	1,75				35	229744 910,00	229748 82,30	229754 237,00	229763 89,90	510106 30,20
M 14	2							229755 240,00	229764 89,90	510130 32,60
M 16	2							229756 245,00	229765 94,30	510151 34,90
M 18	2,5	229757 250,00	229766 94,30	510174 37,70						
M 20	2,5	229758 254,00	229767 94,30	510216 40,60						

Preise für weitere Gewindearten und glatte Lehren auf Anfrage

Optionen: Schmutz- bzw. Luftnut; oberflächenbehandelt z.B. hartverchromt, TiN oder DLC- beschichtet; integriertes Funkmodul
MultiCheck Einstelllehre € 263,- (Art.-Nr. 592010)

Montageschlüssel € 12,- (Art.-Nr. 229768)

Unser Standardlieferprogramm beinhaltet Systemgrößen, innerhalb deren Gewindegrößen, von Ø 2-10 mm und ≤20 mm, unterschiedlicher Gewindearten gewechselt werden können.

MultiCheck Digital mit integriertem Funk-Modul (MCDW) auf Anfrage

- Prüfung der Lehrenhaltigkeit und die Messung der Gewindetiefen mit nur einem Messmittel
- Gewindeprüfzyklus bis zu 50% reduziert
- Definierte Abflachung am ersten Gewinegang ermöglicht eine exakte Messung der lehrenhaltigen Einschraubtiefe des Gewindes
- Einfaches und fehlerfreies Ablesen der Gewindetiefe durch kontrastreiche Ziffernanzeige (Ablesegenauigkeit 0,01mm)
- Kosteneinsparungspotential durch Reduzierung der Gerätezahl und einfachen, schnellen Wechsel der Lehreinsätze

Prices for other thread types and smooth gauges on request

Options: dirt or air groove; surface-treated e.g. hard-chrome plated, TiN or DLC-coated; integrated wireless module
Multicheck setting gauge € 263,- (article no. 592010)

Assembly wrench € 12,- (article no. 229768)

Our standard delivery programme includes system sizes within whose thread sizes, of Ø 2-10 mm and ≤20 mm, of different thread types can be changed.

MultiCheck digital with integrated wireless data transmission (MCDW) on request

- One single measuring device for checking both - accuracy to thread size and thread depth
- Thread gauging cycle time reduced by 50%
- Defined flattening on the first thread enables an exact measurement of the thread's screw-in depth in the gauge
- Easy and error-free reading of the thread depth due to high-contrast numerical display (reading accuracy 0.01mm)
- Cost-saving potential due to the simple and quick change of gauge inserts



M

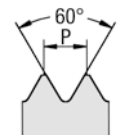

Koordinatenmessdorne

Metrisches ISO-Gewinde DIN 13

Ausführung: Steigungsverzug im Gewinde
Stützt sich an zwei Gewindeflanken ab

Anwendung: Bestimmung der Position und Winkligkeit eines Innengewindes mittels 3D Messmaschine

Coordinate gauge rod

ISO metric thread DIN 13

Specification: Pitch correction in the thread
Fitted in two thread flanks for centric mounting

Usage: Determination of position and angularity of the thread via 3D measuring machine

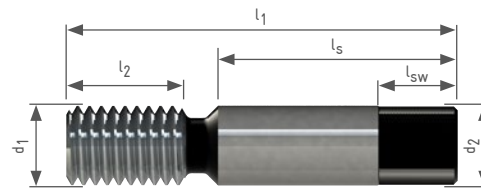

ORDER-CODE								KD	
d	P mm	d ₂	l ₁	l ₂	l _s	sw	l _{sw}	Koordinatenmessdorn Coordinate gauge rod	
↓									
								Art.-Nr.	€
M 3	0,5	6	26	5	18	4	6	220629	241,00
M 4	0,7	6	29	7	18	4	6	220630	230,00
M 5	0,8	6	29	8	18	4	6	220631	225,00
M 6	1	6	31	10	18	4	6	220632	225,00
M 8	1,25	8	41	13	24	6	8	220258	225,00
M 10	1,5	10	49	15	30	8	10	220635	241,00
M 12	1,75	12	59	18	36	10	12	220636	252,00
M 14	2	14	67	20	42	12	14	220637	274,00
M 16	2	16	73	20	48	14	16	220638	296,00

Preise für weitere Gewinde auf Anfrage

Prices for other threads on request

Präzisions-Gewindelehren

Metrisches ISO-Feingewinde DIN 13

Lehrenmaße nach DIN ISO 1502

Precision thread gauges

ISO metric fine thread DIN 13

Gauge dimensions acc. DIN ISO 1502



LD

LD-DLC



ORDER-CODE →		LD	LD-6G	LD-DLC	LD-4H	LD-LH	LD-6G-LH	LD-5H
d	P mm	6H Grenzlehndorn Plug gauge P=0,2 Tol. 4H	6G Grenzlehndorn Plug gauge	6H Grenzlehndorn GD: DLC-Härte HV 0,05 > 5000 Plug gauge GD: DLC hardness HV 0.05 > 5000	4H Grenzlehndorn Plug gauge	6H links Grenzlehndorn left hand Plug gauge	6G links Grenzlehndorn left hand Plug gauge	5H Grenzlehndorn Plug gauge
↓	↓							
		Art.-Nr. €	Art.-Nr. €	Art.-Nr. €	Art.-Nr. €	Art.-Nr. €	Art.-Nr. €	Art.-Nr. €
M 1	0,2	530859 260,00						514276 260,00
M 1,2	0,2	528018 258,00						514294 263,00
M 1,4	0,2	513456 251,00						511633 251,00
M 1,6	0,2	517010 239,00						514210 239,00
M 1,8	0,2	513362 235,00						513520 235,00
M 2	0,2	518211 229,00						511869 229,00
M 2,5	0,2	530985 224,00						511889 224,00
M 2	0,25	511872 169,00			514143 210,00			511870 169,00
M 2,2	0,25	511878 169,00						511877 169,00
M 2,5	0,25	511891 164,00			513132 204,00			511890 164,00
M 3	0,25	512053 164,00			512051 204,00			512050 164,00
M 3,5	0,25	512068 174,00						512067 174,00
M 4	0,25	514142 174,00						512188 174,00
M 5	0,25	512235 172,00						512233 172,00
M 6	0,25	513946 172,00						514948 172,00
M 2,5	0,35	511892 122,00			513962 ○	513976 ○		
M 3	0,35	512054 108,00			513713 136,00	512056 136,00		
M 3,5	0,35	512069 108,00			512070 136,00	512071 136,00		
M 4	0,35	512190 102,00			514398 128,00	514591 128,00		
M 4,5	0,35	512205 146,00						
M 5	0,35	512236 146,00						
M 6	0,35	512270 151,00						
M 7	0,35	512291 151,00						
M 8	0,35	512320 159,00						
M 9	0,35	512348 159,00						
M 10	0,35	520002 164,00						
M 3,5	0,5	512072 120,00						
M 4	0,5	512195 80,50	512197 92,60	512791 101,00	512196 101,00	512198 103,00		
M 4,5	0,5	512206 90,30	512207 104,00		517022 ○	517168 ○		
M 5	0,5	512238 78,10	512240 89,70	516834 97,10	514083 98,30	512242 98,30		
M 5,5	0,5	512248 151,00	512249 158,00					

○ am Lager, Preis auf Anfrage

○ in stock, price on request



M
MF
MJ
EG M

G
Rc, R
Pg

UNC
UNF
UN
UNJF

NPT
NPTF

M
MF
M keg.
M taper

G
BSW
BSF
DIN 477
R, BA, Pg

UNC
UNF
UN, UNS

NPSM
NPT
NPTF
Tr, Rd

M
MF

G
BSW
BSF
R, Pg
MF-EL

UNC, UNF
UNEF
UN, UNS
UNJC
UNJF

NPT
NPTF
Tr
EG

Präzisions-Gewindelehren

Metrisches ISO-Feingewinde DIN 13

Lehrenmaße nach DIN ISO 1502

Precision thread gauges

ISO metric fine thread DIN 13

Gauge dimensions acc. DIN ISO 1502

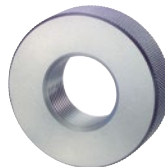

GR

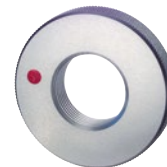

AR



ORDER-CODE →		GR	AR	GR-6e	AR-6e	GR-6h	AR-6h		
d	P mm	6g Gutlehring GO ring gauge ≤ M 1,4 Tol. 6h 	6g Ausschusslehring NOT GO ring gauge ≤ M 1,4 Tol. 6h 	6e Gutlehring GO ring gauge 	6e Ausschusslehring NOT GO ring gauge 	6h Gutlehring GO ring gauge 	6h Ausschusslehring NOT GO ring gauge 		
↓	↓	Art.-Nr.	€	Art.-Nr.	€	Art.-Nr.	€	Art.-Nr.	€
M 1*	0,2	503692	373,00	503693	373,00	siehe Spalte 1 see column 1		siehe Spalte 2 see column 2	
M 1,2*	0,2	503704	365,00	503705	365,00				
M 1,4*	0,2	501438	355,00	500143	355,00				
M 1,6	0,2	501445	342,00	500150	342,00	504191	579,00	504192	579,00
M 1,8	0,2	503212	327,00	503213	327,00	501451	554,00	500157	554,00
M 2	0,2	501709	322,00	500413	322,00	547089	544,00	540740	544,00
M 2,5	0,2	501732	314,00	500436	314,00	501731	533,00	500435	533,00
M 2	0,25	501711	244,00	500416	244,00	501710	446,00	500414	446,00
M 2,2	0,25	501717	225,00	500423	225,00	505599	459,00	500422	459,00
M 2,5	0,25	501735	236,00	500437	236,00	501733	457,00	503559	457,00
M 3	0,25	503544	231,00	503545	231,00	501912	437,00	500605	437,00
M 3,5	0,25	543778	231,00	504324	231,00	503004	443,00	500616	443,00
M 4	0,25	503709	223,00	503710	223,00	502055	434,00	500740	434,00
M 5	0,25	503840	220,00	503841	220,00	503079	436,00	503080	436,00
M 6	0,25	503491	220,00	503492	220,00	520151	498,00	520152	498,00
M 2,5	0,35	501736	85,00	500438	85,00	501738	○	500440	○
M 3	0,35	501913	67,50	500607	67,50	501914	81,00	500608	81,00
M 3,5	0,35	501925	66,40	500617	66,40	501926	○	500618	○
M 4	0,35	502057	61,10	500742	61,10	502059	○	500743	○
M 4,5	0,35	502074	93,90	500757	93,90				
M 5	0,35	502149	96,70	500834	96,70				
M 6	0,35	502225	96,70	500907	96,70				
M 7	0,35	502275	122,00	500952	122,00				
M 8	0,35	502311	122,00	500992	122,00				
M 9	0,35	502350	125,00	501026	125,00				
M 10	0,35	501461	125,00	500169	125,00				
M 3,5	0,5	501927	89,30	500620	89,30				
M 4	0,5	502062	55,60	500745	55,60	502065	68,90	500748	68,90
M 4,5	0,5	502075	73,00	500758	70,90	502076	87,90	500759	87,90
M 5	0,5	502152	55,60	500836	55,60	502155	68,90	500838	68,90
M 5,5	0,5	502166	159,00	500849	159,00				

* Toleranz 6g auf Anfrage ○ am Lager, Preis auf Anfrage

* tolerance 6g on request ○ in stock, price on request



Präzisions-Gewindelehren

Metrisches ISO-Feingewinde DIN 13

Lehrenmaße nach DIN ISO 1502

Precision thread gauges

ISO metric fine thread DIN 13

Gauge dimensions acc. DIN ISO 1502

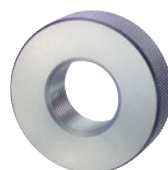

GR

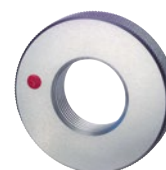

AR



ORDER-CODE →		GR-4h	AR-4h	GR-LH	AR-LH		
d	P mm	4h Gutlehring GO ring gauge	4h Ausschusslehring NOT GO ring gauge	6g links Gutlehring left hand GO ring gauge	6g links Ausschusslehring left hand NOT GO ring gauge		
↓	↓						
		Art.-Nr.	€	Art.-Nr.	€	Art.-Nr.	€
M 1	0,2						
M 1,2	0,2						
M 1,4	0,2						
M 1,6	0,2						
M 1,8	0,2						
M 2	0,2						
M 2,5	0,2						
M 2	0,25	502822	○	500415	○		
M 2,2	0,25						
M 2,5	0,25	501734	○	502795	○		
M 3*	0,25						
M 3,5	0,25						
M 4	0,25						
M 5	0,25						
M 6	0,25						
M 2,5	0,35	501737	98,80	500439	98,80	506071	○
M 3	0,35	503341	85,00	503342	85,00	501916	88,40
M 3,5	0,35	503200	81,80	503201	81,80	503655	81,80
M 4	0,35	502058	76,90	502796	76,90	503683	79,20
M 4,5	0,35						
M 5	0,35						
M 6	0,35						
M 7	0,35						
M 8	0,35						
M 9	0,35						
M 10	0,35						
M 3,5	0,5						
M 4	0,5	502064	70,00	500747	70,00	502067	79,10
M 4,5	0,5	505904	○	503530	○	503934	89,20
M 5	0,5	502154	70,00	500837	70,00	502158	79,10
M 5,5	0,5						

○ am Lager, Preis auf Anfrage

○ in stock, price on request



M
MF
MJ
EG M

G
Rc, R
Pg

UNC
UNF
UN
UNJF

NPT
NPTF

M
MF
M keg.
M taper

G
BSW
BSF
DIN 477
R, BA, Pg

UNC
UNF
UNEF
UN, UNS

NPSM
NPT
NPTF
Tr, Rd

M
MF

G
BSW
BSF
R, Pg
MF-EL

UNC, UNF
UNEF
UN, UNS
UNJC
UNJF

NPT
NPTF
Tr
EG

Präzisions-Gewindelehren

Metrisches ISO-Feingewinde DIN 13

Lehrenmaße nach DIN ISO 1502

Precision thread gauges

ISO metric fine thread DIN 13

Gauge dimensions acc. DIN ISO 1502

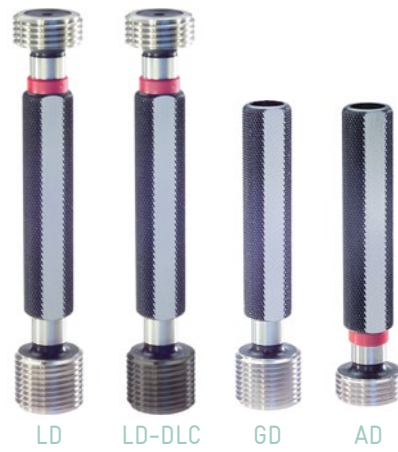

MF

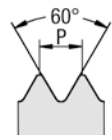

ORDER-CODE →		LD	GD	AD	LD-6G	GD-6G	AD-6G	LD-DLC
d	P mm	6H Grenzlehrdorn Plug gauge	6H Gutlehrdorn GO plug gauge	6H Ausschusslehrdorn NOT GO plug gauge	6G Grenzlehrdorn Plug gauge	6G Gutlehrdorn GO plug gauge	6G Ausschusslehrdorn NOT GO plug gauge	6H Grenzlehrdorn GD: DLC-Härte HV 0,05 > 5000 Plug gauge GO: DLC hardness HV 0.05 > 5000
↓	↓							
		Art.-Nr. €	Art.-Nr. €	Art.-Nr. €	Art.-Nr. €	Art.-Nr. €	Art.-Nr. €	Art.-Nr. €
M 6	0,5	512271 77,40			512274 89,10			512798 100,00
M 6,5	0,5	512285 151,00						
M 7	0,5	512292 79,70			512294 93,40			
M 7,5	0,5	512301 153,00						
M 8	0,5	512321 80,40			512324 92,40			
M 8,5	0,5	512343 153,00						
M 9	0,5	512350 91,60			512351 112,00			
M 10	0,5	511656 88,90			511657 104,00			
M 11	0,5	511681 102,00			514114 123,00			
M 12	0,5	511699 96,40			511700 111,00			
M 13	0,5	511722 112,00						
M 14	0,5	511736 105,00			511738 124,00			
M 15	0,5	511762 123,00			511763 148,00			
M 16	0,5	511785 117,00			511787 143,00			
M 17	0,5	511812 148,00			518297 177,00			
M 18	0,5	511825 132,00			513016 167,00			
M 19	0,5	511845 166,00						
M 20	0,5	511909 148,00			516782 181,00			
M 21	0,5	511927 226,00						
M 22	0,5	511939 236,00						
M 23	0,5	511960 244,00						
M 24	0,5	511970 238,00						
M 25	0,5	514233 244,00						
M 26	0,5	512999 245,00						
M 27	0,5	513054 245,00						
M 28	0,5	513285 247,00						
M 29	0,5	513562 250,00						
M 30	0,5	513366 250,00						
M 31	0,5	512095 252,00						
M 32	0,5	512097 252,00						
M 33	0,5	512110 296,00						

Präzisions-Gewindelehren

Metrisches ISO-Feingewinde DIN 13

Lehrenmaße nach DIN ISO 1502

Precision thread gauges

ISO metric fine thread DIN 13

Gauge dimensions acc. DIN ISO 1502



LD

GD

AD



ORDER-CODE →		LD-4H	GD-4H	AD-4H	LD-LH	GD-LH	AD-LH	LD-6G-LH
d	P mm	4H Grenzlehndorn Plug gauge	4H Gutlehndorn GO plug gauge	4H Ausschusslehndorn NOT GO plug gauge	6H links Grenzlehndorn left hand Plug gauge	6H links Gutlehndorn left hand GO plug gauge	6H links Ausschusslehndorn left hand NOT GO plug gauge	6G links Grenzlehndorn left hand Plug gauge
↓	↓							
		Art.-Nr. €	Art.-Nr. €	Art.-Nr. €	Art.-Nr. €	Art.-Nr. €	Art.-Nr. €	Art.-Nr. €
M 6	0,5	512272 97,50			512276 97,50			
M 6,5	0,5							
M 7	0,5				514592 102,00			
M 7,5	0,5							
M 8	0,5	512322 103,00			512325 103,00			
M 8,5	0,5							
M 9	0,5				514593 121,00			
M 10	0,5	514341 114,00			513087 114,00			
M 11	0,5	514631 131,00			517169 141,00			
M 12	0,5	514328 124,00			513466 128,00			
M 13	0,5	516917 148,00						
M 14	0,5	513088 139,00			517171 139,00			
M 15	0,5				514594 155,00			
M 16	0,5				514595 150,00			
M 17	0,5				517172 190,00			
M 18	0,5				514596 175,00			
M 19	0,5							
M 20	0,5							
M 21	0,5							
M 22	0,5							
M 23	0,5							
M 24	0,5							
M 25	0,5							
M 26	0,5							
M 27	0,5							
M 28	0,5							
M 29	0,5							
M 30	0,5							
M 31	0,5							
M 32	0,5							
M 33	0,5							



M
MF
MJ
EG M

G
Rc, R
Pg

UNC
UNF
UN
UNJF

NPT
NPTF

M
MF
M keg.
M taper

G
BSW
BSF
DIN 477
R, BA, Pg

UNC
UNF
UNEF
UN, UNS

NPSM
NPT
NPTF
Tr, Rd

M
MF

G
BSW
BSF
R, Pg
MF-EL

UNC, UNF
UNEF
UN, UNS
UNJC
UNJF

NPT
NPTF
Tr
EG

M
MF
MJ
EG M

G
Rc, R
Pg

UNC
UNF
UN
UNJF

NPT
NPTF

M
MF
M keg.
M taper

G
BSW
BSF
DIN 477
R, BA, Pg

UNC
UNF
UN, UNS

NPSM
NPT
NPTF
Tr, Rd

M
MF

G
BSW
BSF
R, Pg
MF-EL

UNC, UNF
UNEF
UN, UNS
UNJC
UNJF

NPT
NPTF
Tr
EG

Präzisions-Gewindelehren

Metrisches ISO-Feingewinde DIN 13

Lehrenmaße nach DIN ISO 1502

Precision thread gauges

ISO metric fine thread DIN 13

Gauge dimensions acc. DIN ISO 1502

MF

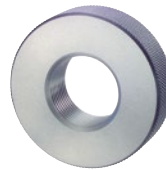
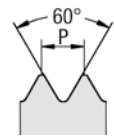

GR

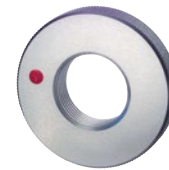

AR



ORDER-CODE →		GR	AR	GR-6e	AR-6e	GR-6h	AR-6h							
d	P mm	6g Gutlehring GO ring gauge	6g Ausschusslehring NOT GO ring gauge	6e Gutlehring GO ring gauge	6e Ausschusslehring NOT GO ring gauge	6h Gutlehring GO ring gauge	6h Ausschusslehring NOT GO ring gauge							
↓	↓													
		Art.-Nr.	€	Art.-Nr.	€	Art.-Nr.	€	Art.-Nr.	€	Art.-Nr.	€			
M 6	0,5	502228	56,20	500910	56,20	502230	68,60	500912	68,60	502231	82,30	500913	82,30	
M 6,5	0,5	502241	159,00	500922	159,00									
M 7	0,5	502276	58,70	500953	58,70	502277	68,10	500955	68,10	502278	83,50	500956	83,50	
M 7,5	0,5	502284	156,00	502740	156,00									
M 8	0,5	502312	60,30	500993	60,30	502314	73,10	500995	73,10	502315	86,30	500996	86,30	
M 8,5	0,5	502330	156,00	501011	156,00									
M 9	0,5	502351	65,60	501027	65,60	502353	75,50	501029	75,50	503951	90,60	501030	90,60	
M 10	0,5	501462	67,40	500170	67,40	501463	79,00	500172	79,00	502852	95,00	502853	95,00	
M 11	0,5	501496	81,90	500204	81,90	501498	94,20	500206	94,20	501499	104,00	500207	104,00	
M 12	0,5	501523	77,30	500231	77,30	501524	90,20	500232	90,20	501525	109,00	500233	109,00	
M 13	0,5	501558	98,80	500262	98,80	505714	114,00	502727	114,00	505715	125,00	502728	125,00	
M 14	0,5	501577	93,80	500284	93,80	501579	103,00	500286	103,00	502734	120,00	502735	120,00	
M 15	0,5	501610	101,00	500313	101,00	503074	119,00	500314	119,00	503380	134,00	500315	134,00	
M 16	0,5	501629	104,00	500336	104,00	501631	125,00	500338	125,00	503581	130,00	503582	130,00	
M 17	0,5	501653	118,00	500361	118,00	506090	136,00	506112	136,00	506107	145,00	506110	145,00	
M 18	0,5	501667	117,00	500374	117,00					503382	148,00	505847	148,00	
M 19	0,5	501690	134,00	500397	134,00					506108	172,00	506111	172,00	
M 20	0,5	501754	126,00	500455	126,00	506096	○	506114	○	506109	164,00	505464	164,00	
M 21	0,5	502741	220,00	502755	220,00									
M 22	0,5	501787	229,00	500482	229,00									
M 23	0,5	501807	229,00	500502	229,00									
M 24	0,5	501821	229,00	500515	229,00									
M 25	0,5	501842	237,00	500534	237,00									
M 26	0,5	502744	256,00	502743	256,00									
M 27	0,5	501872	256,00	500563	256,00									
M 28	0,5	501887	256,00	500580	256,00									
M 29	0,5	502975	256,00	502976	256,00									
M 30	0,5	503070	256,00	500628	256,00									
M 31	0,5	503261	282,00	503260	282,00									
M 32	0,5	502942	282,00	502943	282,00									
M 33	0,5	502979	287,00	502980	287,00									

○ am Lager, Preis auf Anfrage

○ in stock, price on request



Präzisions-Gewindelehren

Metrisches ISO-Feingewinde DIN 13

Lehrenmaße nach DIN ISO 1502

Precision thread gauges

ISO metric fine thread DIN 13

Gauge dimensions acc. DIN ISO 1502

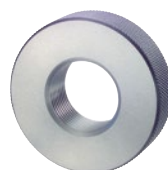

GR

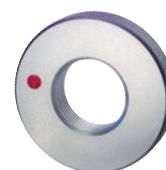

AR



ORDER-CODE →		GR-4h	AR-4h	GR-LH	AR-LH				
d	P mm	4h Gutlehring GO ring gauge	4h Ausschusslehring NOT GO ring gauge	6g links Gutlehring left hand GO ring gauge	6g links Ausschusslehring left hand NOT GO ring gauge				
↓	↓								
		Art.-Nr.	€	Art.-Nr.	€	Art.-Nr.	€	Art.-Nr.	€
M 6	0,5	502229	70,60	500911	70,60	502232	82,30	500914	82,30
M 6,5	0,5								
M 7	0,5	503193	73,90	503194	73,90	503935	81,70	503942	81,70
M 7,5	0,5								
M 8	0,5	502313	76,00	500994	76,00	502316	86,30	500997	86,30
M 8,5	0,5								
M 9	0,5	502352	82,70	501028	82,70	503936	88,50	503943	88,50
M 10	0,5	503188	84,80	500171	84,80	501464	95,00	500173	95,00
M 11	0,5					506072	111,00	506081	111,00
M 12	0,5	502860	97,40	502861	97,40	503937	109,00	503944	109,00
M 13	0,5	503072	125,00	503073	125,00	506073	119,00	506082	119,00
M 14	0,5	501578	118,00	500285	118,00	506074	118,00	506083	118,00
M 15	0,5	505828	○	503334	○	503938	130,00	506084	130,00
M 16	0,5	501630	○	500337	○	503939	128,00	503945	128,00
M 17	0,5	506097	○	506102	○	506075	149,00	506085	149,00
M 18	0,5	506098	○	506103	○	503940	155,00	503946	155,00
M 19	0,5	506099	○	503566	○	506076	○	506086	○
M 20	0,5	505924	○	505923	○	506077	○	506087	○
M 21	0,5								
M 22	0,5								
M 23	0,5								
M 24	0,5								
M 25	0,5								
M 26	0,5								
M 27	0,5								
M 28	0,5								
M 29	0,5								
M 30	0,5								
M 31	0,5								
M 32	0,5								
M 33	0,5								

○ am Lager, Preis auf Anfrage

○ in stock, price on request



Präzisions-Gewindelehren

Metrisches ISO-Feingewinde DIN 13

Lehrenmaße nach DIN ISO 1502

Precision thread gauges

ISO metric fine thread DIN 13

Gauge dimensions acc. DIN ISO 1502



MF

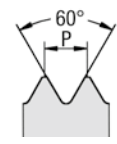

ORDER-CODE →		LD	GD	AD	LD-6G	GD-6G	AD-6G	LD-DLC
d	P mm	6H Grenzlehndorn Plug gauge	6H Gutlehdorn GO plug gauge	6H Ausschusslehndorn NOT GO plug gauge	6G Grenzlehndorn Plug gauge	6G Gutlehdorn GO plug gauge	6G Ausschusslehndorn NOT GO plug gauge	6H Grenzlehndorn GD: DLC-Härte HV 0,05 > 5000 Plug gauge GO: DLC hardness HV 0.05 > 5000
↓	↓							
		Art.-Nr. €	Art.-Nr. €	Art.-Nr. €	Art.-Nr. €	Art.-Nr. €	Art.-Nr. €	Art.-Nr. €
M 34	0,5	512125 301,00						
M 35	0,5	512134 305,00						
M 36	0,5	513561 314,00						
M 37	0,5	514184 324,00						
M 38	0,5	514226 333,00						
M 39	0,5	513747 344,00						
M 40	0,5	514150 354,00						
M 5	0,75	512243 62,20						
M 6	0,75	512277 52,30			512280 58,00			512799 73,70
M 7	0,75	512295 56,00			512298 65,20			
M 8	0,75	512326 54,90			512327 58,10			512803 81,50
M 9	0,75	512352 62,10			512354 72,60			
M 10	0,75	511659 58,60			511661 68,50			512733 86,50
M 11	0,75	511682 66,50			511683 79,90			
M 12	0,75	511701 63,30			511702 75,20			512739 94,00
M 13	0,75	511723 69,10			513284 82,90			
M 14	0,75	511739 69,10			511742 80,60			
M 15	0,75	511764 73,90			511765 86,20			
M 16	0,75	511789 73,90			511790 86,20			
M 17	0,75	511813 84,30			511814 101,00			
M 18	0,75	511826 78,00			511828 91,00			
M 19	0,75	511846 91,60			511847 107,00			
M 20	0,75	511910 86,40			514211 104,00			
M 21	0,75	511928 99,10			511929 119,00			
M 22	0,75	511940 102,00			511941 119,00			
M 23	0,75	512997 110,00			523226 128,00			
M 24	0,75	511971 109,00						
M 25	0,75	511984 113,00			513970 ○			
M 26	0,75	511993 116,00						
M 27	0,75	512009 117,00			512010 ○			
M 28	0,75	512025 121,00						

○ am Lager, Preis auf Anfrage

○ in stock, price on request



Präzisions-Gewindelehren

Metrisches ISO-Feingewinde DIN 13

Lehrenmaße nach DIN ISO 1502

Precision thread gauges

ISO metric fine thread DIN 13

Gauge dimensions acc. DIN ISO 1502



ORDER-CODE →		LD-4H	GD-4H	AD-4H	LD-LH	GD-LH	AD-LH	LD-6G-LH	
d	P mm	4H Grenzlehndorn Plug gauge	4H Gutlehndorn GO plug gauge	4H Ausschusslehndorn NOT GO plug gauge	6H links Grenzlehndorn left hand Plug gauge	6H links Gutlehndorn left hand GO plug gauge	6H links Ausschusslehndorn left hand NOT GO plug gauge	6G links Grenzlehndorn left hand Plug gauge	
↓	↓								
		Art.-Nr.	€	Art.-Nr.	€	Art.-Nr.	€	Art.-Nr.	€
M 34	0,5								
M 35	0,5								
M 36	0,5								
M 37	0,5								
M 38	0,5								
M 39	0,5								
M 40	0,5								
M 5	0,75								
M 6	0,75	512278	69,90		512281	67,90		513003	79,20
M 7	0,75	512296	70,50		513676	68,50		514225	87,20
M 8	0,75	514632	67,90		512329	67,90			
M 9	0,75	517211	81,90		514031	81,90			
M 10	0,75	511660	73,90		511662	71,80		517197	91,70
M 11	0,75	517212	83,80		514468	83,80			
M 12	0,75	517214	81,30		513885	79,00			
M 13	0,75	517213	91,20		514597	87,10			
M 14	0,75	511740	87,10		511744	84,60			
M 15	0,75				513785	93,20			
M 16	0,75	516771	93,20		511791	90,50			
M 17	0,75				517176	106,00			
M 18	0,75				516901	○			
M 19	0,75								
M 20	0,75				514340	109,00			
M 21	0,75								
M 22	0,75	514661	124,00		517216	○			
M 23	0,75				514635	○			
M 24	0,75				514320	133,00			
M 25	0,75								
M 26	0,75				517217	○			
M 27	0,75								
M 28	0,75								

○ am Lager, Preis auf Anfrage

○ in stock, price on request



M
MF
MJ
EG M

G
Rc, R
Pg

UNC
UNF
UN
UNJF

NPT
NPTF

M
MF
M keg.
M taper

G
BSW
BSF
DIN 477
R, BA, Pg

UNC
UNF
UNEF
UN, UNS

NPSM
NPT
NPTF
Tr, Rd

M
MF

G
BSW
BSF
R, Pg
MF-EL

UNC, UNF
UNEF
UN, UNS
UNJC
UNJF

NPT
NPTF
Tr
EG



Präzisions-Gewindelehren

Metrisches ISO-Feingewinde DIN 13

Lehrenmaße nach DIN ISO 1502

Precision thread gauges

ISO metric fine thread DIN 13

Gauge dimensions acc. DIN ISO 1502

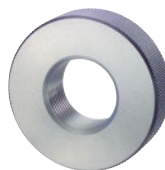

GR

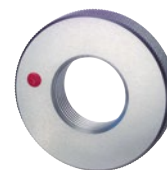

AR



ORDER-CODE →		GR	AR	GR-6e	AR-6e	GR-6h	AR-6h						
d	P mm	6g Gutlehring GO ring gauge	6g Ausschusslehring NOT GO ring gauge	6e Gutlehring GO ring gauge	6e Ausschusslehring NOT GO ring gauge	6h Gutlehring GO ring gauge	6h Ausschusslehring NOT GO ring gauge						
↓	↓												
		Art.-Nr.	€	Art.-Nr.	€	Art.-Nr.	€	Art.-Nr.	€	Art.-Nr.	€	Art.-Nr.	€
M 34	0,5	501989	287,00	500676	287,00								
M 35	0,5	501997	293,00	500685	293,00								
M 36	0,5	503262	297,00	503263	297,00								
M 37	0,5	503629	297,00	503630	297,00								
M 38	0,5	502814	344,00	502815	344,00								
M 39	0,5	502040	344,00	500724	344,00								
M 40	0,5	502077	344,00	500760	344,00								
M 5	0,75	502160	57,20	500843	57,20	502162	○	505752	○	505931	70,00	505932	70,00
M 6	0,75	502234	43,80	500916	43,80	502237	49,50	500918	49,50	502238	63,90	500919	63,90
M 7	0,75	502279	53,00	500957	53,00	502281	59,10	500959	59,10	502282	64,80	500960	64,80
M 8	0,75	502317	45,50	500998	45,50	502319	51,40	501000	51,40	502320	65,00	501001	65,00
M 9	0,75	502354	57,50	501031	57,50	502355	64,20	501032	64,20	503130	81,70	503131	81,70
M 10	0,75	501465	49,60	500174	49,60	501466	57,00	500176	57,00	501467	72,50	500177	72,50
M 11	0,75	501500	63,80	500208	63,80	501501	73,50	500209	73,50	501502	80,40	505442	80,40
M 12	0,75	501526	58,30	500234	58,30	501528	65,20	500236	65,20	501529	79,90	500237	79,90
M 13	0,75	501559	72,90	500263	72,90	501560	83,90	500264	83,90	505583	96,50	500265	96,50
M 14	0,75	501580	62,90	500287	62,90	501582	75,90	500289	75,90	501583	83,20	500290	83,20
M 15	0,75	501611	82,60	500316	82,60	501612	90,40	500317	90,40	505786	104,00	503117	104,00
M 16	0,75	501632	72,50	500339	72,50	501634	83,30	500341	83,30	501635	91,20	503376	91,20
M 17	0,75	501654	91,60	500362	91,60	501655	102,00	500363	102,00	501656	115,00	500364	115,00
M 18	0,75	501668	78,10	500375	78,10	501669	89,80	500376	89,80	503526	98,50	503525	98,50
M 19	0,75	501691	93,60	500398	93,60	501692	113,00	505459	113,00	503554	118,00	503977	118,00
M 20	0,75	501755	83,20	500456	83,20	501756	96,20	500457	96,20	502903	105,00	502904	105,00
M 21	0,75	501774	105,00	500474	105,00								
M 22	0,75	501788	98,10	500484	98,10	506150	○	506163	○	501789	○	500485	○
M 23	0,75	501808	113,00	500503	113,00	506151	○	506164	○	501809	○	505468	○
M 24	0,75	501822	105,00	500516	105,00					503976	132,00	506181	132,00
M 25	0,75	501843	106,00	500535	106,00					505936	140,00	505937	140,00
M 26	0,75	501856	115,00	500547	115,00					506189	159,00	506182	159,00
M 27	0,75	501873	125,00	500564	125,00	506186	○	506187	○				
M 28	0,75	501888	128,00	500582	128,00								

○ am Lager, Preis auf Anfrage

○ in stock, price on request



Präzisions-Gewindelehren

Metrisches ISO-Feingewinde DIN 13

Lehrenmaße nach DIN ISO 1502

Precision thread gauges

ISO metric fine thread DIN 13

Gauge dimensions acc. DIN ISO 1502

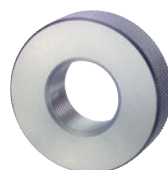

GR

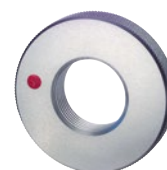

AR



ORDER-CODE →		GR-4h	AR-4h	GR-LH	AR-LH					
d	P mm	4h Gutlehring GO ring gauge	4h Ausschusslehring NOT GO ring gauge	6g links Gutlehring left hand GO ring gauge	6g links Ausschusslehring left hand NOT GO ring gauge					
↓	↓									
		Art.-Nr.	€	Art.-Nr.	€	Art.-Nr.	€	Art.-Nr.	€	
M 34	0,5									
M 35	0,5									
M 36	0,5									
M 37	0,5									
M 38	0,5									
M 39	0,5									
M 40	0,5									
M 5	0,75					503264	74,20	503265	74,20	
M 6	0,75	502236	54,20	500917	54,20	502239	57,40	500920	57,40	
M 7	0,75	502280	64,80	500958	64,80	502283	68,70	500961	68,70	
M 8	0,75	502318	56,30	500999	56,30	502321	58,50	501002	58,50	
M 9	0,75	503948	70,40	503950	70,40	502783	70,40	502782	70,40	
M 10	0,75	503150	62,50	500175	62,50	501468	65,00	500178	65,00	
M 11	0,75	506100	80,40	506104	80,40	501503	80,40	500210	80,40	
M 12	0,75	501527	71,30	500235	71,30	501530	71,70	500238	71,70	
M 13	0,75	503541	91,90	503553	91,90	506078	91,90	506088	91,90	
M 14	0,75	501581	79,20	500288	79,20	501584	79,20	500291	79,20	
M 15	0,75	503949	99,10	506105	99,10	503399	99,10	505856	99,10	
M 16	0,75	501633	91,20	500340	91,20	501636	91,20	500342	91,20	
M 17	0,75	506101	115,00	506106	115,00	506079	115,00	506089	115,00	
M 18	0,75	506156	103,00	506169	103,00	503241	98,50	503242	98,50	
M 19	0,75	506157	124,00	506170	124,00	501693	124,00	505460	124,00	
M 20	0,75	502762	110,00	502763	110,00	502787	105,00	502788	105,00	
M 21	0,75	501775	132,00	500475	132,00	503954	132,00	503962	132,00	
M 22	0,75	503965	129,00	503971	129,00	506134	124,00	506142	124,00	
M 23	0,75	506158	142,00	506171	142,00	503102	142,00	503101	142,00	
M 24	0,75	501823	132,00	500517	132,00	503587	128,00	503723	128,00	
M 25	0,75	503966	147,00	506172	147,00	501844	140,00	500536	140,00	
M 26	0,75	506159	159,00	506173	159,00	505970	152,00	506143	152,00	
M 27	0,75	503967	153,00	506174	153,00	505610	153,00	506144	153,00	
M 28	0,75	506160	158,00	506175	158,00	505902	162,00	506145	162,00	



Präzisions-Gewindelehren

Metrisches ISO-Feingewinde DIN 13

Lehrenmaße nach DIN ISO 1502

Precision thread gauges

ISO metric fine thread DIN 13

Gauge dimensions acc. DIN ISO 1502

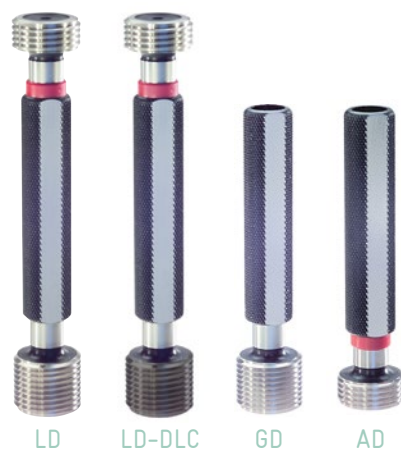

ORDER-CODE →		LD	GD	AD	LD-6G	GD-6G	AD-6G	LD-DLC
d	P mm	6H Grenzlehrdorn Plug gauge	6H Gutlehrdorn GO plug gauge	6H Ausschusslehrdorn NOT GO plug gauge	6G Grenzlehrdorn Plug gauge	6G Gutlehrdorn GO plug gauge	6G Ausschusslehrdorn NOT GO plug gauge	6H Grenzlehrdorn GD: DLC-Härte HV 0,05 > 5000 Plug gauge GO: DLC hardness HV 0.05 > 5000
↓	↓							
		Art.-Nr. €	Art.-Nr. €	Art.-Nr. €	Art.-Nr. €	Art.-Nr. €	Art.-Nr. €	Art.-Nr. €
M 29	0,75	512034 130,00						
M 30	0,75	512078 125,00						
M 31	0,75	513442 293,00						
M 32	0,75	516791 293,00						
M 33	0,75	512111 294,00						
M 34	0,75	516445 294,00						
M 35	0,75	513917 297,00						
M 36	0,75	512147 297,00						
M 37	0,75	513182 299,00						
M 38	0,75	512159 299,00						
M 39	0,75	512168 308,00						
M 40	0,75	512208 302,00						
M 8	1	512331 48,30			512335 54,00			512804 73,30
M 9	1	512356 52,90			512359 62,10			
M 10	1	511663 50,90			511668 56,80			512735 77,60
M 11	1	511684 56,40			511685 67,70			
M 12	1	511703 55,30			511706 61,80			512740 83,60
M 13	1	511724 64,30			511725 77,20			
M 14	1	511745 58,80			511747 71,50			512745 94,10
M 15	1	511766 66,60			511768 79,90			
M 16	1	511792 63,10			511795 76,00			512750 98,10
M 17	1	511815 71,50			511816 85,80			
M 18	1	511829 66,10			511831 80,40			512753 112,00
M 19	1	511849 78,70			511851 96,20			
M 20	1	511911 70,60			511913 84,80			512760 117,00
M 21	1	511930 89,10			511932 109,00			
M 22	1	511942 79,20			511945 94,90			
M 23	1	511961 96,00			511962 115,00			
M 24	1	511972 85,20			511974 102,00			
M 25	1	511985 94,10			511986 113,00			
M 26	1	511994 97,00			511995 116,00			



Präzisions-Gewindelehren

Metrisches ISO-Feingewinde DIN 13

Lehrenmaße nach DIN ISO 1502

Precision thread gauges

ISO metric fine thread DIN 13

Gauge dimensions acc. DIN ISO 1502



LD

GD

AD



ORDER-CODE →		LD-4H	GD-4H	AD-4H	LD-LH	GD-LH	AD-LH	LD-6G-LH			
d	P mm	4H Grenzlehndorn Plug gauge	4H Gutlehdorn GO plug gauge	4H Ausschusslehndorn NOT GO plug gauge	6H links Grenzlehndorn left hand Plug gauge	6H links Gutlehdorn left hand GO plug gauge	6H links Ausschusslehndorn left hand NOT GO plug gauge	6G links Grenzlehndorn left hand Plug gauge			
↓	↓										
		Art.-Nr.	€	Art.-Nr.	€	Art.-Nr.	€	Art.-Nr.	€	Art.-Nr.	€
M 29	0,75										
M 30	0,75										
M 31	0,75										
M 32	0,75										
M 33	0,75										
M 34	0,75										
M 35	0,75										
M 36	0,75										
M 37	0,75										
M 38	0,75										
M 39	0,75										
M 40	0,75										
M 8	1	512332	61,40		512340	61,40		512341	71,50		
M 9	1	512358	66,70		512360	68,60		514643	84,80		
M 10	1	511665	64,80		511673	64,80		511674	73,90		
M 11	1	514205	69,50		511686	70,90		517227	94,80		
M 12	1	511704	70,40		511708	70,40		511710	81,90		
M 13	1	514005	82,70		511727	81,10		517228	105,00		
M 14	1	513384	74,80		511751	74,80		513215	94,80		
M 15	1	511767	85,60		511770	83,90					
M 16	1	511794	79,40		511799	79,40		520023	101,00		
M 17	1	514668	91,90		511817	91,90		517236	123,00		
M 18	1	511830	84,90		511832	83,30		517238	110,00		
M 19	1	511850	104,00		511853	99,10					
M 20	1	511912	89,10		511915	89,10		520026	112,00		
M 21	1	514662	118,00		520014	118,00					
M 22	1	511944	99,80		511947	99,80		520027	129,00		
M 23	1	514663	123,00		520016	123,00					
M 24	1	511973	107,00		511975	107,00		520028	139,00		
M 25	1	513153	125,00		514639	119,00		520029	154,00		
M 26	1	513451	125,00		520019	122,00					



M
MF
MJ
EG M

G
Rc, R
Pg

UNC
UNF
UN
UNJF

NPT
NPTF

M
MF
M keg.
M taper

G
BSW
BSF
DIN 477
R, BA, Pg

UNC
UNF
UNEF
UN, UNS

NPSM
NPT
NPTF
Tr, Rd

M
MF

G
BSW
BSF
R, Pg
MF-EL

UNC, UNF
UNEF
UN, UNS
UNJC
UNJF

NPT
NPTF
Tr
EG

M
MF
MJ
EG M

G
Rc, R
Pg

UNC
UNF
UN
UNJF

NPT
NPTF

M
MF
M keg.
M taper

G
BSW
BSF
DIN 477
R, BA, Pg

UNC
UNF
UNEF
UN, UNS

NPSM
NPT
NPTF
Tr, Rd

M
MF

G
BSW
BSF
R, Pg
MF-EL

UNC, UNF
UNEF
UN, UNS
UNJC
UNJF

NPT
NPTF
Tr
EG

Präzisions-Gewindelehren

Metrisches ISO-Feingewinde DIN 13

Lehrenmaße nach DIN ISO 1502

Precision thread gauges

ISO metric fine thread DIN 13

Gauge dimensions acc. DIN ISO 1502

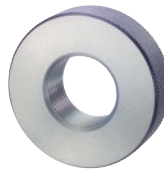

GR

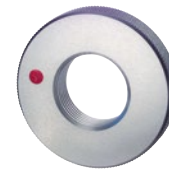

AR



ORDER-CODE →		GR	AR	GR-6e	AR-6e	GR-6h	AR-6h				
d	P mm	6g Gutlehring GO ring gauge	6g Ausschusslehring NOT GO ring gauge	6e Gutlehring GO ring gauge	6e Ausschusslehring NOT GO ring gauge	6h Gutlehring GO ring gauge	6h Ausschusslehring NOT GO ring gauge				
↓	↓										
		Art.-Nr.	€	Art.-Nr.	€	Art.-Nr.	€	Art.-Nr.	€	Art.-Nr.	€
M 29	0,75	501899	158,00	500592	158,00						
M 30	0,75	501934	128,00	500630	128,00	506155	155,00	506168	155,00	503835	170,00
M 31	0,75	503105	242,00	500648	242,00						
M 32	0,75	501958	245,00	500651	245,00						
M 33	0,75	502916	250,00	500666	250,00						
M 34	0,75	502918	257,00	500677	257,00						
M 35	0,75	501998	262,00	500686	262,00						
M 36	0,75	502014	269,00	500699	269,00						
M 37	0,75	502968	274,00	500710	274,00						
M 38	0,75	502932	281,00	500714	281,00						
M 39	0,75	503580	314,00	500725	314,00						
M 40	0,75	502078	293,00	500761	293,00						
M 8	1	502322	40,50	501003	40,50	502325	46,80	501006	46,80	502326	50,90
M 9	1	502357	51,70	501034	51,70	502358	57,80	501035	57,80	502359	63,20
M 10	1	501470	45,20	500179	45,20	501474	52,50	500182	52,50	501475	57,00
M 11	1	501504	58,50	500211	58,50	501505	65,40	500212	65,40	501506	71,60
M 12	1	501531	51,30	500239	51,30	501535	59,60	500242	59,60	501536	64,60
M 13	1	501561	68,90	500266	68,90	501562	79,20	500267	79,20	501563	86,80
M 14	1	501585	55,30	500292	55,30	501587	64,30	500293	64,30	501588	78,10
M 15	1	501613	72,40	500318	72,40	501615	84,80	500320	84,80	501616	91,20
M 16	1	501637	60,60	500343	60,60	501640	69,50	500347	69,50	501641	76,30
M 17	1	501657	70,20	500365	70,20	501658	82,30	500366	82,30	501659	90,30
M 18	1	501670	66,70	500377	66,70	501673	78,20	500380	78,20	501674	85,70
M 19	1	501695	81,10	500399	81,10	501696	97,90	500400	97,90	502778	107,00
M 20	1	501757	71,60	500458	71,60	501759	84,00	500460	84,00	501760	92,10
M 21	1	501776	87,20	500476	87,20	505602	105,00	505466	105,00	505808	115,00
M 22	1	501790	79,20	500486	79,20	501792	93,00	500488	93,00	501793	102,00
M 23	1	501811	91,30	500505	91,30	501812	110,00	500506	110,00	501813	121,00
M 24	1	501824	84,50	500518	84,50	501826	99,10	500519	99,10	501827	109,00
M 25	1	501845	89,50	500537	89,50	501846	108,00	500538	108,00	501847	115,00
M 26	1	501857	92,60	500548	92,60	501858	112,00	500549	112,00	501859	122,00



Präzisions-Gewindelehren

Metrisches ISO-Feingewinde DIN 13

Lehrenmaße nach DIN ISO 1502

Precision thread gauges

ISO metric fine thread DIN 13

Gauge dimensions acc. DIN ISO 1502

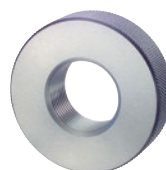

GR

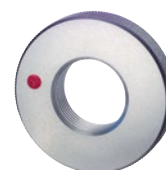

AR



ORDER-CODE →		GR-4h	AR-4h	GR-LH	AR-LH					
d	P mm	4h Gutlehring GO ring gauge	4h Ausschusslehring NOT GO ring gauge	6g links Gutlehring left hand GO ring gauge	6g links Ausschusslehring left hand NOT GO ring gauge					
↓	↓									
		Art.-Nr.	€	Art.-Nr.	€	Art.-Nr.	€	Art.-Nr.	€	
M 29	0,75									
M 30	0,75					506185	162,00	506146	162,00	
M 31	0,75									
M 32	0,75									
M 33	0,75									
M 34	0,75									
M 35	0,75									
M 36	0,75									
M 37	0,75									
M 38	0,75									
M 39	0,75									
M 40	0,75									
M 8	1	502324	51,40	501005	51,40	502327	51,40	501008	51,40	
M 9	1	505670	63,20	503927	63,20	502360	63,20	501037	63,20	
M 10	1	501472	57,60	500181	57,60	501477	57,60	500185	57,60	
M 11	1	503234	71,60	503235	71,60	502747	71,60	502746	71,60	
M 12	1	501533	65,30	500241	65,30	501537	65,30	500244	65,30	
M 13	1	503082	86,80	505771	86,80	501564	86,80	500269	86,80	
M 14	1	501586	71,80	503269	71,80	501589	70,40	500295	70,40	
M 15	1	501614	91,20	500319	91,20	501617	93,00	500322	93,00	
M 16	1	501639	77,90	500346	77,90	501643	76,30	500349	76,30	
M 17	1	502902	93,00	503826	93,00	501660	93,00	500368	93,00	
M 18	1	501672	85,70	500379	85,70	501675	85,70	500382	85,70	
M 19	1	503542	112,00	503973	112,00	501697	107,00	500402	107,00	
M 20	1	501758	90,30	500459	90,30	501761	90,30	500462	90,30	
M 21	1	503146	115,00	503147	115,00	506137	115,00	506147	115,00	
M 22	1	501791	105,00	500487	105,00	501794	105,00	500490	105,00	
M 23	1	503969	121,00	503974	121,00	506139	121,00	506148	121,00	
M 24	1	501825	112,00	505470	112,00	501828	109,00	500522	109,00	
M 25	1	502900	118,00	503751	118,00	503313	115,00	503314	115,00	
M 26	1	502899	119,00	503975	119,00	501860	119,00	500551	119,00	



Präzisions-Gewindelehren

Metrisches ISO-Feingewinde DIN 13

Lehrenmaße nach DIN ISO 1502

Precision thread gauges

ISO metric fine thread DIN 13

Gauge dimensions acc. DIN ISO 1502

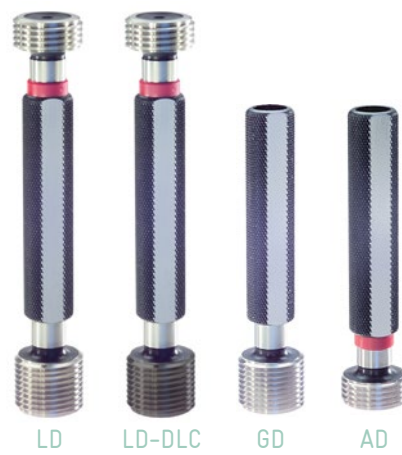

MF

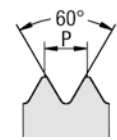

ORDER-CODE →		LD	GD	AD	LD-6G	GD-6G	AD-6G	LD-DLC
d	P mm	6H Grenzlehrdorn Plug gauge	6H Gutlehrdorn GO plug gauge	6H Ausschusslehrdorn NOT GO plug gauge	6G Grenzlehrdorn Plug gauge	6G Gutlehrdorn GO plug gauge	6G Ausschusslehrdorn NOT GO plug gauge	6H Grenzlehrdorn GD: DLC-Härte HV 0,05 > 5000 Plug gauge GO: DLC hardness HV 0.05 > 5000
↓	↓							
		Art.-Nr. €	Art.-Nr. €	Art.-Nr. €	Art.-Nr. €	Art.-Nr. €	Art.-Nr. €	Art.-Nr. €
M 27	1	512011 101,00			512012 121,00			
M 28	1	512026 103,00			512027 124,00			
M 29	1	512035 117,00			513718 140,00			
M 30	1	512079 105,00			512081 126,00			
M 32	1	512098 108,00			512099 129,00			
M 33	1	512112 112,00			512114 137,00			
M 34	1	512126 115,00			516792 138,00			
M 35	1	512135 122,00			514470 150,00			
M 36	1	512148 125,00			512149 150,00			
M 38	1	512160 134,00			512161 164,00			
M 39	1	512169 176,00						
M 40	1	512209 144,00			512210 173,00			
M 42	1		511113 83,30	510384 77,60				
M 45	1		511123 89,00	510396 81,70				
M 48	1		511138 95,70	510410 87,80				
M 50	1		511165 99,90	510435 91,70				
M 52	1		511175 104,00	510445 95,30				
M 55	1		513565 112,00	513566 102,00				
M 56	1		511188 114,00	510458 104,00				
M 58	1		511194 120,00	510465 110,00				
M 60	1		511212 125,00	513147 115,00				
M 62	1		513478 145,00	513479 131,00				
M 64	1		513730 148,00	513731 133,00				
M 65	1		514015 151,00	514016 135,00				
M 68	1		511228 159,00	516620 143,00				
M 70	1		511239 163,00	510507 147,00				
M 72	1		520030 168,00	520033 151,00				
M 75	1		520031 180,00	520034 162,00				
M 76	1		511249 181,00	520035 163,00				
M 78	1		520032 192,00	520036 173,00				
M 80	1		511273 190,00	520037 171,00				

Präzisions-Gewindelehren

Metrisches ISO-Feingewinde DIN 13

Lehrenmaße nach DIN ISO 1502

Precision thread gauges

ISO metric fine thread DIN 13

Gauge dimensions acc. DIN ISO 1502



ORDER-CODE →		LD-4H	GD-4H	AD-4H	LD-LH	GD-LH	AD-LH	LD-6G-LH	
d	P mm	4H Grenzlehndorn Plug gauge	4H Gutlehdorn GO plug gauge	4H Ausschusslehndorn NOT GO plug gauge	6H links Grenzlehndorn left hand Plug gauge	6H links Gutlehdorn left hand GO plug gauge	6H links Ausschusslehndorn left hand NOT GO plug gauge	6G links Grenzlehndorn left hand Plug gauge	
↓	↓								
		Art.-Nr.	€	Art.-Nr.	€	Art.-Nr.	€	Art.-Nr.	€
M 27	1	514664	133,00			512014	127,00		
M 28	1	514665	133,00			513575	130,00		
M 29	1	514666	150,00			520022	147,00		
M 30	1	512080	132,00			512082	132,00	517267	172,00
M 32	1	514200	143,00			512100	136,00		
M 33	1	512113	148,00			512115	141,00		
M 34	1	514674	148,00			512128	148,00		
M 35	1	514675	157,00			512136	154,00		
M 36	1	514676	160,00			516794	157,00		
M 38	1	517272	177,00			517222	169,00		
M 39	1								
M 40	1	516799	191,00			512211	186,00		
M 42	1							513222	110,00
M 45	1							513673	118,00
M 48	1							520040	103,00
M 50	1							514650	127,00
M 52	1							514651	116,00
M 55	1							516866	132,00
M 56	1							516867	121,00
M 58	1							517229	138,00
M 60	1							517230	126,00
M 62	1							517231	146,00
M 64	1							517232	133,00
M 65	1							517233	143,00
M 68	1							517234	131,00
M 70	1							517235	159,00
M 72	1							517237	146,00
M 75	1							517239	165,00
M 76	1							517240	152,00
M 78	1								
M 80	1								



M
MF
MJ
EG M

G
Rc, R
Pg

UNC
UNF
UN
UNJF

NPT
NPTF

M
MF
M keg.
M taper

G
BSW
BSF
DIN 477
R, BA, Pg

UNC
UNF
UN, UNS

NPSM
NPT
NPTF
Tr, Rd

M
MF

G
BSW
BSF
R, Pg
MF-EL

UNC, UNF
UNF
UN, UNS
UNJC
UNJF

NPT
NPTF
Tr
EG

Präzisions-Gewindelehren

Metrisches ISO-Feingewinde DIN 13

Lehrenmaße nach DIN ISO 1502

Precision thread gauges

ISO metric fine thread DIN 13

Gauge dimensions acc. DIN ISO 1502

MF

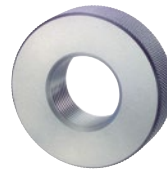
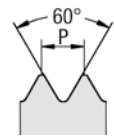

GR

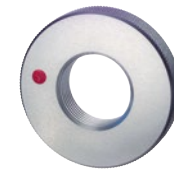

AR



ORDER-CODE →		GR	AR	GR-6e	AR-6e	GR-6h	AR-6h						
d	P mm	6g Gutlehring GO ring gauge	6g Ausschusslehring NOT GO ring gauge	6e Gutlehring GO ring gauge	6e Ausschusslehring NOT GO ring gauge	6h Gutlehring GO ring gauge	6h Ausschusslehring NOT GO ring gauge						
↓	↓												
		Art.-Nr.	€	Art.-Nr.	€	Art.-Nr.	€	Art.-Nr.	€	Art.-Nr.	€	Art.-Nr.	€
M 27	1	501874	94,90	500565	94,90	501876	115,00	500566	115,00	501877	122,00	500567	122,00
M 28	1	501889	98,60	500583	98,60	501891	119,00	500584	119,00	501892	127,00	500585	127,00
M 29	1	501900	159,00	500593	159,00								
M 30	1	501935	99,80	500631	99,80	501937	121,00	500632	121,00	501938	128,00	500633	128,00
M 32	1	501959	112,00	500652	112,00	501961	135,00	500653	135,00	501962	148,00	503089	148,00
M 33	1	501977	114,00	500667	114,00	503097	134,00	503098	134,00	501978	151,00	506215	151,00
M 34	1	501990	116,00	500678	116,00	503719	140,00	506130	140,00	501991	154,00	503498	154,00
M 35	1	501999	119,00	500687	119,00	502000	143,00	503664	143,00	502001	157,00	503985	157,00
M 36	1	502015	123,00	500700	123,00	502016	149,00	505479	149,00	505617	159,00	506216	159,00
M 38	1	502031	128,00	500715	128,00	502875	154,00	502876	154,00	505720	177,00	503986	177,00
M 39	1	502041	158,00	500726	158,00								
M 40	1	502079	139,00	500762	139,00	502877	162,00	502878	162,00	502879	178,00	502880	178,00
M 42	1	502095	143,00	500778	143,00	502096	172,00	503602	172,00	505626	189,00	503987	189,00
M 45	1	502109	152,00	500793	152,00	505760	183,00	505761	183,00	503827	195,00	506217	195,00
M 48	1	502127	161,00	500808	161,00	506129	188,00	500809	188,00	506196	212,00	506218	212,00
M 50	1	502168	166,00	500852	166,00	505830	195,00	505831	195,00	503982	220,00	506219	220,00
M 52	1	502178	174,00	500862	174,00	506131	204,00	503953	204,00	505946	240,00	505947	240,00
M 55	1	502794	181,00	502793	181,00	506132	212,00	506133	212,00	505925	240,00	505926	240,00
M 56	1	502200	185,00	500878	185,00	503955	234,00	503956	234,00	506197	244,00	506220	244,00
M 58	1	502209	191,00	500890	191,00	506135	243,00	506136	243,00	506198	255,00	506221	255,00
M 60	1	502245	198,00	500924	198,00	505649	240,00	505509	240,00	506199	263,00	506222	263,00
M 62	1	506643	234,00	500932	234,00								
M 64	1	504044	240,00	504314	240,00								
M 65	1	503522	244,00	500941	244,00								
M 68	1	503496	252,00	520154	252,00								
M 70	1	502892	259,00	520155	259,00								
M 72	1	520153	271,00	520156	271,00								
M 75	1	502293	290,00	500972	290,00								
M 76	1	507386	293,00	520157	293,00								
M 78	1	502298	311,00	520158	311,00								
M 80	1	502333	307,00	520159	307,00								



Präzisions-Gewindelehren

Metrisches ISO-Feingewinde DIN 13

Lehrenmaße nach DIN ISO 1502

Precision thread gauges

ISO metric fine thread DIN 13

Gauge dimensions acc. DIN ISO 1502

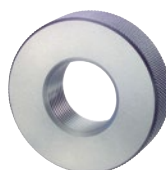

GR

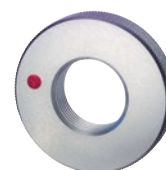

AR



ORDER-CODE →		GR-4h	AR-4h	GR-LH	AR-LH					
d	P mm	4h Gutlehring GO ring gauge	4h Ausschusslehring NOT GO ring gauge	6g links Gutlehring left hand GO ring gauge	6g links Ausschusslehring left hand NOT GO ring gauge					
↓	↓									
		Art.-Nr.	€	Art.-Nr.	€	Art.-Nr.	€	Art.-Nr.	€	
M 27	1	501875	126,00	506188	126,00	501878	126,00	500568	126,00	
M 28	1	503970	130,00	506177	130,00	501893	127,00	500586	127,00	
M 29	1									
M 30	1	501936	128,00	503700	128,00	501939	126,00	500634	126,00	
M 32	1	501960	148,00	506200	148,00	501963	144,00	500654	144,00	
M 33	1	503957	151,00	506201	151,00	502990	147,00	502989	147,00	
M 34	1	505890	161,00	505891	161,00	502838	154,00	500679	154,00	
M 35	1	506138	157,00	506202	157,00	502002	153,00	505478	153,00	
M 36	1	505921	163,00	506203	163,00	503047	159,00	500701	159,00	
M 38	1	503958	169,00	506204	169,00	502032	164,00	505480	164,00	
M 39	1									
M 40	1	503959	178,00	503983	178,00	503267	178,00	503268	178,00	
M 42	1	503960	183,00	506205	183,00	502995	183,00	502994	183,00	
M 45	1	506140	210,00	506206	210,00	503256	195,00	503257	195,00	
M 48	1	503961	206,00	503984	206,00	506116	206,00	506117	206,00	
M 50	1	505862	220,00	503414	220,00	505636	230,00	505955	230,00	
M 52	1	506141	230,00	506207	230,00	503952	223,00	506118	223,00	
M 55	1	506190	240,00	506208	240,00	506119	235,00	506120	235,00	
M 56	1	506191	244,00	506209	244,00	506121	244,00	506122	244,00	
M 58	1	506192	255,00	506210	255,00	506123	255,00	506124	255,00	
M 60	1	506193	263,00	506211	263,00	506125	263,00	506126	263,00	
M 62	1									
M 64	1									
M 65	1									
M 68	1									
M 70	1									
M 72	1									
M 75	1									
M 76	1									
M 78	1									
M 80	1									



Präzisions-Gewindelehren

Metrisches ISO-Feingewinde DIN 13

Lehrenmaße nach DIN ISO 1502

Precision thread gauges

ISO metric fine thread DIN 13

Gauge dimensions acc. DIN ISO 1502

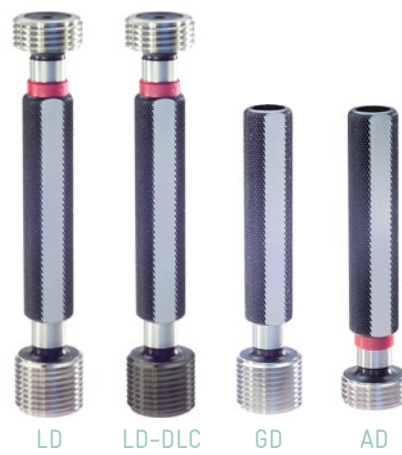

MF

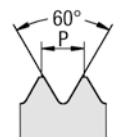

ORDER-CODE →		LD	GD	AD	LD-6G	GD-6G	AD-6G	LD-DLC
d	P mm	6H Grenzlehrdorn Plug gauge	6H Gutlehrdorn GO plug gauge	6H Ausschusslehrdorn NOT GO plug gauge	6G Grenzlehrdorn Plug gauge	6G Gutlehrdorn GO plug gauge	6G Ausschusslehrdorn NOT GO plug gauge	6H Grenzlehrdorn GD: DLC-Härte HV 0,05 > 5000 Plug gauge GO: DLC hardness HV 0.05 > 5000
↓	↓							
		Art.-Nr. €	Art.-Nr. €	Art.-Nr. €	Art.-Nr. €	Art.-Nr. €	Art.-Nr. €	Art.-Nr. €
M 10	1,25	511675 59,30			511676 71,90			513639 86,80
M 12	1,25	511711 63,00			511713 76,30			520038 ○
M 14	1,25	511752 72,70			511754 89,00			
M 16	1,25	511800 174,00						
M 18	1,25	511833 206,00						
M 20	1,25	511917 219,00						
M 22	1,25	514324 224,00						
M 24	1,25	514109 228,00						
M 12	1,5	511716 50,40			511718 55,80			512742 78,20
M 13	1,5	511728 105,00						
M 14	1,5	511755 53,80			511759 59,70			512747 88,60
M 15	1,5	511771 66,60			511772 81,50			
M 16	1,5	511802 56,30			511806 62,50			512751 91,40
M 17	1,5	511818 93,50			511819 110,00			
M 18	1,5	511835 59,80			511837 66,30			512754 106,00
M 19	1,5	511855 140,00						
M 20	1,5	511918 64,20			511920 71,20			512761 110,00
M 21	1,5	511933 151,00						
M 22	1,5	511948 70,50			511951 85,50			512765 125,00
M 24	1,5	511976 75,70			511978 91,70			512769 130,00
M 25	1,5	511989 78,70			511990 94,20			512771 ○
M 26	1,5	511997 81,10			512000 97,40			512772 ○
M 27	1,5	512015 83,60			512018 100,00			512773 ○
M 28	1,5	512028 86,00			512030 103,00			512775 ○
M 30	1,5	512083 92,70			512085 111,00			512783 ○
M 32	1,5	512101 94,90			512103 114,00			
M 33	1,5	512117 97,40			512118 117,00			
M 34	1,5	512130 103,00			512131 137,00			
M 35	1,5	512137 102,00			512138 122,00			
M 36	1,5	512150 104,00			512151 125,00			
M 38	1,5	512162 113,00			512163 136,00			

○ am Lager, Preis auf Anfrage

○ in stock, price on request



Präzisions-Gewindelehren

Metrisches ISO-Feingewinde DIN 13

Lehrenmaße nach DIN ISO 1502

Precision thread gauges

ISO metric fine thread DIN 13

Gauge dimensions acc. DIN ISO 1502



ORDER-CODE →		LD-4H	GD-4H	AD-4H	LD-LH	GD-LH	AD-LH	LD-6G-LH		
d	P mm	4H Grenzlehndorn Plug gauge	4H Gutlehdorn GO plug gauge	4H Ausschusslehndorn NOT GO plug gauge	6H links Grenzlehndorn left hand Plug gauge	6H links Gutlehdorn left hand GO plug gauge	6H links Ausschusslehndorn left hand NOT GO plug gauge	6G links Grenzlehndorn left hand Plug gauge		
↓	↓									
		Art.-Nr.	€	Art.-Nr.	€	Art.-Nr.	€	Art.-Nr.	€	
M 10	1,25	513961	75,50			511677	75,50		514054	95,30
M 12	1,25	512991	81,70			511715	80,10		514268	99,20
M 14	1,25	511753	96,20			514640	93,40		517241	119,00
M 16	1,25									
M 18	1,25									
M 20	1,25									
M 22	1,25									
M 24	1,25									
M 12	1,5	511717	65,30			511720	64,10		511721	74,10
M 13	1,5									
M 14	1,5	511756	68,30			511760	68,30		511761	79,20
M 15	1,5	517274	92,30			517224	88,10			
M 16	1,5	511804	71,60			511810	71,60		511811	81,30
M 17	1,5	517275	121,00			517225	121,00			
M 18	1,5	511836	77,50			511841	76,00		511842	87,80
M 19	1,5									
M 20	1,5	511919	83,20			511922	81,60		516783	92,50
M 21	1,5									
M 22	1,5	511949	89,80			511954	89,80		514653	113,00
M 24	1,5	511977	96,30			511979	96,30		511980	122,00
M 25	1,5	514677	99,10			511991	99,10		517268	129,00
M 26	1,5	511998	107,00			512002	102,00		517242	133,00
M 27	1,5	512016	107,00			512019	105,00		517243	133,00
M 28	1,5	512029	111,00			512031	108,00		517244	141,00
M 30	1,5	512084	117,00			512087	117,00		512088	147,00
M 32	1,5	512102	122,00			512105	120,00		514654	155,00
M 33	1,5	513155	123,00			512119	123,00		517245	159,00
M 34	1,5	514698	132,00			512132	132,00			
M 35	1,5	514026	131,00			512140	128,00		517246	162,00
M 36	1,5	513746	134,00			512152	131,00		514655	171,00
M 38	1,5	513915	145,00			512164	142,00		514402	180,00



M
MF
MJ
EG M

G
Rc, R
Pg

UNC
UNF
UN
UNJF

NPT
NPTF

M
MF
M keg.
M taper

G
BSW
BSF
DIN 477
R, BA, Pg

UNC
UNF
UN, UNS

NPSM
NPT
NPTF
Tr, Rd

M
MF

G
BSW
BSF
R, Pg
MF-EL

UNC, UNF
UNF
UN, UNS
UNJC
UNJF

NPT
NPTF
Tr
EG

Präzisions-Gewindelehren

Metrisches ISO-Feingewinde DIN 13

Lehrenmaße nach DIN ISO 1502

Precision thread gauges

ISO metric fine thread DIN 13

Gauge dimensions acc. DIN ISO 1502

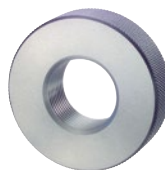

GR

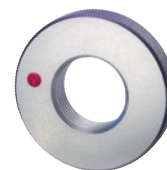

AR



ORDER-CODE →		GR	AR	GR-6e	AR-6e	GR-6h	AR-6h						
d	P mm	6g Gutlehring GO ring gauge	6g Ausschusslehring NOT GO ring gauge	6e Gutlehring GO ring gauge	6e Ausschusslehring NOT GO ring gauge	6h Gutlehring GO ring gauge	6h Ausschusslehring NOT GO ring gauge						
↓	↓												
		Art.-Nr.	€	Art.-Nr.	€	Art.-Nr.	€	Art.-Nr.	€	Art.-Nr.	€	Art.-Nr.	€
M 10	1,25	501479	53,00	500187	53,00	501481	61,50	500189	61,50	501483	67,40	500191	67,40
M 12	1,25	501539	67,50	500246	67,50	501541	78,30	500247	78,30	501542	85,80	500248	85,80
M 14	1,25	501592	75,00	500297	75,00	501594	86,30	500299	86,30	501595	94,40	500300	94,40
M 16	1,25	501644	199,00	500350	199,00								
M 18	1,25	501677	213,00	500384	213,00								
M 20	1,25	501762	222,00	500463	222,00								
M 22	1,25	502890	236,00	505741	236,00								
M 24	1,25	501829	259,00	500523	259,00								
M 12	1,5	501544	48,60	500250	48,60	501547	56,40	500253	56,40	501548	61,80	500254	61,80
M 13	1,5	501565	111,00	500271	111,00	503258	128,00	503259	128,00	503708	140,00	503998	140,00
M 14	1,5	501596	51,80	500301	51,80	501600	60,10	500305	60,10	501601	65,80	500306	65,80
M 15	1,5	501618	69,10	500323	69,10	501619	79,40	500324	79,40	505590	87,00	505453	87,00
M 16	1,5	501645	56,50	500351	56,50	501649	65,60	500356	65,60	501650	71,90	500357	71,90
M 17	1,5	501662	85,10	500369	85,10	502827	103,00	502828	103,00	505991	112,00	503798	112,00
M 18	1,5	501678	60,90	500385	60,90	501682	70,80	500391	70,80	501684	77,60	500392	77,60
M 19	1,5	501698	122,00	500403	122,00								
M 20	1,5	501763	67,40	500464	67,40	501766	78,20	500467	78,20	501767	85,70	500468	85,70
M 21	1,5	501778	166,00	500478	166,00								
M 22	1,5	501795	72,00	500491	72,00	501800	83,60	500496	83,60	501801	91,60	500497	91,60
M 24	1,5	501830	76,50	500524	76,50	501833	88,70	500526	88,70	501834	97,30	500527	97,30
M 25	1,5	501849	80,10	500541	80,10	501851	94,00	505471	94,00	505609	106,00	505472	106,00
M 26	1,5	501862	82,70	500553	82,70	501864	95,20	500554	95,20	501865	106,00	500555	106,00
M 27	1,5	501879	85,70	500569	85,70	501881	101,00	500571	101,00	501882	110,00	500572	110,00
M 28	1,5	501894	87,40	500587	87,40	501895	102,00	500588	102,00	501896	112,00	500589	112,00
M 30	1,5	501941	91,80	500636	91,80	501944	106,00	500638	106,00	501945	116,00	500639	116,00
M 32	1,5	501965	97,40	500656	97,40	501967	114,00	500658	114,00	501968	125,00	500659	125,00
M 33	1,5	501980	99,80	500668	99,80	501981	117,00	500669	117,00	501982	132,00	506479	132,00
M 34	1,5	501992	110,00	500680	110,00	501993	125,00	500681	125,00	501994	141,00	500682	141,00
M 35	1,5	502003	104,00	500688	104,00	502004	126,00	500690	126,00	502005	134,00	500691	134,00
M 36	1,5	502017	107,00	500702	107,00	502019	125,00	500703	125,00	502020	137,00	503017	137,00
M 38	1,5	502033	112,00	500716	112,00	502035	132,00	500718	132,00	502036	149,00	500719	149,00



Präzisions-Gewindelehren

Metrisches ISO-Feingewinde DIN 13

Lehrenmaße nach DIN ISO 1502

Precision thread gauges

ISO metric fine thread DIN 13

Gauge dimensions acc. DIN ISO 1502

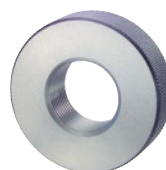

GR

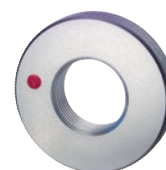

AR



ORDER-CODE →		GR-4h	AR-4h	GR-LH	AR-LH					
d	P mm	4h Gutlehring GO ring gauge	4h Ausschusslehring NOT GO ring gauge	6g links Gutlehring left hand GO ring gauge	6g links Ausschusslehring left hand NOT GO ring gauge					
↓	↓									
		Art.-Nr.	€	Art.-Nr.	€	Art.-Nr.	€	Art.-Nr.	€	
M 10	1,25	502947	67,40	502948	67,40	501484	69,70	500192	69,70	
M 12	1,25	501540	85,80	502949	85,80	501543	85,80	500249	85,80	
M 14	1,25	501593	94,40	500298	94,40	503438	94,40	503439	94,40	
M 16	1,25									
M 18	1,25									
M 20	1,25									
M 22	1,25									
M 24	1,25									
M 12	1,5	501546	61,80	500252	61,80	501549	67,30	500255	67,30	
M 13	1,5	506194	140,00	506212	140,00					
M 14	1,5	501599	65,80	500303	65,80	501602	65,80	500307	65,80	
M 15	1,5	506195	87,00	506213	87,00	503757	87,00	503758	87,00	
M 16	1,5	503278	73,30	500355	73,30	505592	71,90	500359	71,90	
M 17	1,5	503981	112,00	506214	112,00	503768	112,00	503771	112,00	
M 18	1,5	501681	79,10	500390	79,10	501685	77,60	500393	77,60	
M 19	1,5									
M 20	1,5	501765	87,40	500466	87,40	501769	85,70	500470	85,70	
M 21	1,5									
M 22	1,5	501799	93,40	500495	93,40	501802	91,60	500498	91,60	
M 24	1,5	501832	99,30	500525	99,30	501835	97,30	500528	97,30	
M 25	1,5	501850	106,00	500542	106,00	501853	103,00	503236	103,00	
M 26	1,5	501863	115,00	503398	115,00	501866	106,00	500557	106,00	
M 27	1,5	501880	110,00	500570	110,00	501883	110,00	500574	110,00	
M 28	1,5	505613	112,00	505476	112,00	501897	112,00	500590	112,00	
M 30	1,5	501943	116,00	500637	116,00	501946	116,00	500640	116,00	
M 32	1,5	501966	125,00	500657	125,00	501970	125,00	500661	125,00	
M 33	1,5	503034	132,00	503035	132,00	501983	132,00	500670	132,00	
M 34	1,5	506419	141,00	506451	141,00	501995	137,00	500683	137,00	
M 35	1,5	505616	134,00	500689	134,00	502006	134,00	500692	134,00	
M 36	1,5	502018	148,00	505883	148,00	502022	135,00	500704	135,00	
M 38	1,5	502034	144,00	500717	144,00	502037	144,00	500721	144,00	



Präzisions-Gewindelehren

Metrisches ISO-Feingewinde DIN 13

Lehrenmaße nach DIN ISO 1502

Precision thread gauges

ISO metric fine thread DIN 13

Gauge dimensions acc. DIN ISO 1502

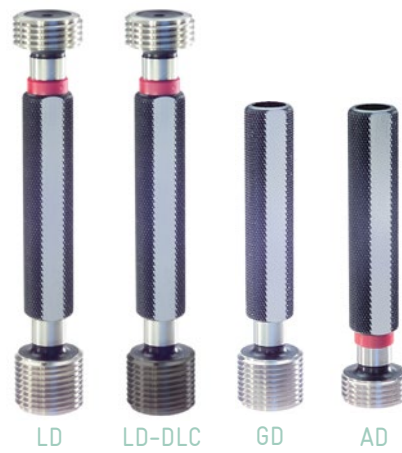

MF

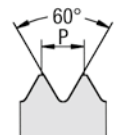

ORDER-CODE →		LD	GD	AD	LD-6G	GD-6G	AD-6G	LD-DLC
d	P mm	6H Grenzlehndorn Plug gauge	6H Gutlehdorn GO plug gauge	6H Ausschusslehndorn NOT GO plug gauge	6G Grenzlehndorn Plug gauge	6G Gutlehdorn GO plug gauge	6G Ausschusslehndorn NOT GO plug gauge	6H Grenzlehndorn GD: DLC-Härte HV 0,05 > 5000 Plug gauge GO: DLC hardness HV 0.05 > 5000
↓	↓							
		Art.-Nr. €	Art.-Nr. €	Art.-Nr. €	Art.-Nr. €	Art.-Nr. €	Art.-Nr. €	Art.-Nr. €
M 39	1,5	512170 121,00						
M 40	1,5	512212 119,00			512214 143,00			
M 42	1,5		511114 72,40	510386 66,60		511115 88,50	510388 81,60	
M 45	1,5		511124 76,90	510397 70,50		511126 92,40	510398 84,70	
M 48	1,5		511140 81,40	510412 75,00		511142 99,60	510413 91,90	
M 50	1,5		511166 83,90	510436 77,60		511167 103,00	510437 94,90	
M 52	1,5		511176 87,20	510446 80,20		511177 107,00	510447 98,10	
M 55	1,5		511184 92,90	510454 85,80		518531 117,00	516615 108,00	
M 56	1,5		511189 94,80	510459 87,20		518947 119,00	518946 110,00	
M 58	1,5		511195 98,00	510466 90,30		518532 123,00	518533 114,00	
M 60	1,5		511213 102,00	510483 94,10		514812 125,00	514813 115,00	
M 62	1,5		511216 105,00	510488 96,80				
M 64	1,5		511219 109,00	510493 100,00				
M 65	1,5		511223 113,00	510496 104,00				
M 68	1,5		511229 116,00	510501 107,00				
M 70	1,5		511240 119,00	510508 110,00				
M 72	1,5		511243 127,00	510511 116,00				
M 75	1,5		511247 132,00	510513 122,00				
M 76	1,5		511250 165,00	513382 149,00				
M 78	1,5		511252 137,00	510517 127,00				
M 80	1,5		511274 141,00	510543 131,00				
M 82	1,5		511278 145,00	510546 133,00				
M 85	1,5		511280 150,00	510547 138,00				
M 88	1,5		516722 155,00	510551 143,00				
M 90	1,5		511296 158,00	510561 147,00				
M 92	1,5		513057 163,00	513056 151,00				
M 95	1,5		511302 166,00	510566 153,00				
M 98	1,5		520042 215,00	520054 194,00				
M 100	1,5		510837 176,00	510089 162,00				
M 102	1,5		510840 217,00	510092 195,00				
M 105	1,5		516858 185,00	513006 171,00				

Präzisions-Gewindelehren

Metrisches ISO-Feingewinde DIN 13

Lehrenmaße nach DIN ISO 1502

Precision thread gauges

ISO metric fine thread DIN 13

Gauge dimensions acc. DIN ISO 1502



ORDER-CODE →		LD-4H	GD-4H	AD-4H	LD-LH	GD-LH	AD-LH	LD-6G-LH			
d	P mm	4H Grenzlehndorn Plug gauge	4H Gutlehdorn GO plug gauge	4H Ausschusslehndorn NOT GO plug gauge	6H links Grenzlehndorn left hand Plug gauge	6H links Gutlehdorn left hand GO plug gauge	6H links Ausschusslehndorn left hand NOT GO plug gauge	6G links Grenzlehndorn left hand Plug gauge			
↓	↓										
		Art.-Nr.	€	Art.-Nr.	€	Art.-Nr.	€	Art.-Nr.	€	Art.-Nr.	€
M 39	1,5										
M 40	1,5	512213	150,00			512215	150,00				
M 42	1,5			518813	95,70	510387	88,10	513096	91,20	513097	83,90
M 45	1,5			511125	98,80	519782	90,60	511127	96,90	510399	88,90
M 48	1,5			511141	113,00	513661	104,00	511143	105,00	510414	96,30
M 50	1,5			523377	108,00	518897	99,60	511168	106,00	510438	97,60
M 52	1,5			514157	112,00	514158	103,00	513626	110,00	513500	101,00
M 55	1,5			526426	123,00	517423	113,00	511185	119,00	510455	110,00
M 56	1,5			523162	131,00	523163	121,00	511190	122,00	510460	112,00
M 58	1,5			515462	130,00	515466	119,00	513185	130,00	513186	119,00
M 60	1,5			514064	135,00	514890	125,00	513228	135,00	513227	125,00
M 62	1,5							517276	139,00	517283	128,00
M 64	1,5							517059	144,00	517060	133,00
M 65	1,5							514678	149,00	516618	137,00
M 68	1,5							514680	149,00	517284	137,00
M 70	1,5							517277	153,00	517285	142,00
M 72	1,5							514681	163,00	517286	150,00
M 75	1,5							514682	175,00	517287	161,00
M 76	1,5										
M 78	1,5							517034	181,00	517288	168,00
M 80	1,5							514683	181,00	514686	168,00
M 82	1,5							514684	192,00	514687	176,00
M 85	1,5							517278	199,00	517289	183,00
M 88	1,5										
M 90	1,5										
M 92	1,5										
M 95	1,5										
M 98	1,5										
M 100	1,5										
M 102	1,5										
M 105	1,5										



M
MF
MJ
EG M

G
Rc, R
Pg

UNC
UNF
UN
UNJF

NPT
NPTF

M
MF
M keg.
M taper

G
BSW
BSF
DIN 477
R, BA, Pg

UNC
UNF
UN, UNS

NPSM
NPT
NPTF
Tr, Rd

M
MF

G
BSW
BSF
R, Pg
MF-EL

UNC, UNF
UNF
UN, UNS
UNJC
UNJF

NPT
NPTF
Tr
EG

Präzisions-Gewindelehren

Metrisches ISO-Feingewinde DIN 13

Lehrenmaße nach DIN ISO 1502

Precision thread gauges

ISO metric fine thread DIN 13

Gauge dimensions acc. DIN ISO 1502

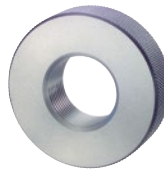

GR

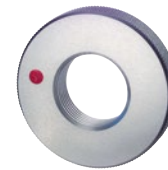

AR



ORDER-CODE →		GR	AR	GR-6e	AR-6e	GR-6h	AR-6h		
d	P mm	6g Gutlehring GO ring gauge	6g Ausschusslehring NOT GO ring gauge	6e Gutlehring GO ring gauge	6e Ausschusslehring NOT GO ring gauge	6h Gutlehring GO ring gauge	6h Ausschusslehring NOT GO ring gauge		
↓	↓								
		Art.-Nr.	€	Art.-Nr.	€	Art.-Nr.	€	Art.-Nr.	€
M 39	1,5	502042	123,00	500727	123,00	502817	148,00	500728	148,00
M 40	1,5	502080	118,00	500763	118,00	502083	139,00	500766	139,00
M 42	1,5	502097	125,00	500779	125,00	502098	146,00	500780	146,00
M 45	1,5	502111	131,00	500794	131,00	502113	153,00	500795	153,00
M 48	1,5	502128	138,00	500810	138,00	502131	161,00	503996	161,00
M 50	1,5	502169	144,00	500853	144,00	502170	169,00	500854	169,00
M 52	1,5	502179	150,00	500863	150,00	502180	176,00	503814	176,00
M 55	1,5	502193	156,00	500874	156,00	502195	189,00	506255	189,00
M 56	1,5	502201	159,00	500879	159,00	505733	202,00	502842	202,00
M 58	1,5	502210	163,00	500891	163,00	503993	197,00	505507	197,00
M 60	1,5	502246	169,00	500925	169,00	502247	198,00	500926	198,00
M 62	1,5	502254	175,00	500933	175,00	506232	222,00	506256	222,00
M 64	1,5	502258	181,00	500936	181,00	505653	229,00	505511	229,00
M 65	1,5	502263	184,00	500942	184,00	502829	233,00	506257	233,00
M 68	1,5	502268	191,00	500945	191,00	503994	241,00	503997	241,00
M 70	1,5	502286	200,00	500964	200,00	503039	241,00	505762	241,00
M 72	1,5	502289	206,00	500967	206,00	506233	249,00	506258	249,00
M 75	1,5	502294	218,00	500973	218,00	506234	263,00	506259	263,00
M 76	1,5	502296	237,00	500976	237,00				
M 78	1,5	502299	234,00	500978	234,00	506235	276,00	506260	276,00
M 80	1,5	502334	237,00	501013	237,00	503040	286,00	501014	286,00
M 82	1,5	502338	248,00	501018	248,00	506236	294,00	506261	294,00
M 85	1,5	502341	256,00	501019	256,00	505996	309,00	505997	309,00
M 88	1,5	502345	273,00	501022	273,00				
M 90	1,5	502362	274,00	503431	274,00				
M 92	1,5	502368	282,00	501041	282,00				
M 95	1,5	502370	292,00	501043	292,00				
M 98	1,5	520160	339,00	520170	339,00				
M 100	1,5	501485	310,00	500194	310,00				
M 102	1,5	501487	350,00	500197	350,00				
M 105	1,5	501488	327,00	500199	327,00				



Präzisions-Gewindelehren

Metrisches ISO-Feingewinde DIN 13

Lehrenmaße nach DIN ISO 1502

Precision thread gauges

ISO metric fine thread DIN 13

Gauge dimensions acc. DIN ISO 1502

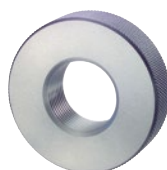

GR

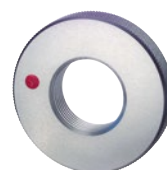

AR



ORDER-CODE →		GR-4h	AR-4h	GR-LH	AR-LH					
d	P mm	4h Gutlehring GO ring gauge	4h Ausschusslehring NOT GO ring gauge	6g links Gutlehring left hand GO ring gauge	6g links Ausschusslehring left hand NOT GO ring gauge					
↓	↓									
		Art.-Nr.	€	Art.-Nr.	€	Art.-Nr.	€	Art.-Nr.	€	
M 39	1,5	503372	163,00	505482	163,00	502044	163,00	500730	163,00	
M 40	1,5	502082	152,00	503159	152,00	502085	149,00	500767	149,00	
M 42	1,5	503484	160,00	503485	160,00	502099	157,00	500781	157,00	
M 45	1,5	502112	165,00	505492	165,00	502115	165,00	500796	165,00	
M 48	1,5	502130	177,00	500811	177,00	502132	177,00	500814	177,00	
M 50	1,5	503446	181,00	503447	181,00	502172	181,00	500856	181,00	
M 52	1,5	503243	189,00	505810	189,00	503464	189,00	503463	189,00	
M 55	1,5	502194	201,00	506459	201,00	503500	201,00	503499	201,00	
M 56	1,5	502203	205,00	500881	205,00	502204	205,00	500882	205,00	
M 58	1,5	502211	209,00	505506	209,00	503988	216,00	503995	216,00	
M 60	1,5	506421	218,00	504051	218,00	503005	218,00	503667	218,00	
M 62	1,5	504047	225,00	504052	225,00	506223	232,00	506242	232,00	
M 64	1,5	506425	240,00	506464	240,00	503468	240,00	505884	240,00	
M 65	1,5	504010	237,00	504011	237,00	503989	244,00	505513	244,00	
M 68	1,5	505742	252,00	506467	252,00	506224	245,00	506243	245,00	
M 70	1,5	505658	256,00	505518	256,00	506225	264,00	506244	264,00	
M 72	1,5	505795	273,00	503153	273,00	503990	265,00	506245	265,00	
M 75	1,5	505759	288,00	505522	288,00	503991	280,00	506246	280,00	
M 76	1,5									
M 78	1,5	506427	303,00	506469	303,00	505906	303,00	506247	303,00	
M 80	1,5	506429	313,00	506471	313,00	506226	304,00	506248	304,00	
M 82	1,5	506431	321,00	506472	321,00	506227	321,00	506249	321,00	
M 85	1,5	506432	328,00	506474	328,00	503992	337,00	506250	337,00	
M 88	1,5									
M 90	1,5									
M 92	1,5									
M 95	1,5									
M 98	1,5									
M 100	1,5									
M 102	1,5									
M 105	1,5									



Präzisions-Gewindelehren

Metrisches ISO-Feingewinde DIN 13

Lehrenmaße nach DIN ISO 1502

Precision thread gauges

ISO metric fine thread DIN 13

Gauge dimensions acc. DIN ISO 1502

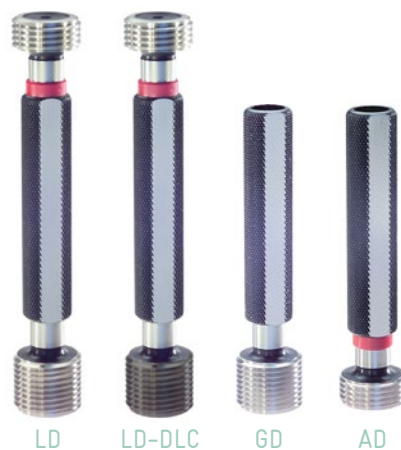

MF

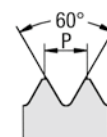

ORDER-CODE →		LD	GD	AD	LD-6G	GD-6G	AD-6G	LD-DLC
d	P mm	6H Grenzlehrdorn Plug gauge	6H Gutlehrdorn GO plug gauge	6H Ausschusslehrdorn NOT GO plug gauge	6G Grenzlehrdorn Plug gauge	6G Gutlehrdorn GO plug gauge	6G Ausschusslehrdorn NOT GO plug gauge	6H Grenzlehrdorn GD: DLC-Härte HV 0,05 > 5000 Plug gauge GO: DLC hardness HV 0.05 > 5000
↓	↓							
		Art.-Nr. €	Art.-Nr. €	Art.-Nr. €	Art.-Nr. €	Art.-Nr. €	Art.-Nr. €	Art.-Nr. €
M 108	1,5		520044 230,00	520055 207,00				
M 110	1,5		510850 194,00	513931 180,00				
M 112	1,5		510853 233,00	510105 209,00				
M 115	1,5		520045 240,00	520056 216,00				
M 118	1,5		520046 247,00	520057 223,00				
M 120	1,5		520047 250,00	520058 225,00				
M 122	1,5		516664 270,00	520059 242,00				
M 125	1,5		520048 262,00	520060 236,00				
M 128	1,5		510875 283,00	510124 255,00				
M 130	1,5		517861 273,00	517862 246,00				
M 132	1,5		518665 278,00	520061 250,00				
M 135	1,5		520049 290,00	517018 261,00				
M 138	1,5		520050 298,00	520062 267,00				
M 140	1,5		520051 301,00	520063 271,00				
M 142	1,5		518196 299,00	520064 270,00				
M 145	1,5		520052 313,00	520065 281,00				
M 148	1,5		520053 319,00	520066 288,00				
M 150	1,5		518077 324,00	518078 292,00				
M 18	2	511843 66,40			511844 81,10			
M 20	2	511923 68,80			511924 83,90			
M 22	2	511955 73,50			511957 92,50			
M 24	2	511981 77,90			511982 93,50			
M 25	2	511992 82,70			514267 101,00			
M 26	2	512003 85,50			512004 105,00			
M 27	2	512020 84,80			512022 104,00			
M 28	2	512032 90,60			512033 111,00			
M 30	2	512089 93,20			512091 112,00			
M 32	2	512106 97,00			512107 119,00			
M 33	2	512120 99,80			512121 120,00			
M 34	2	512133 133,00						
M 35	2	512142 136,00						

Präzisions-Gewindelehren

Metrisches ISO-Feingewinde DIN 13

Lehrenmaße nach DIN ISO 1502

Precision thread gauges

ISO metric fine thread DIN 13

Gauge dimensions acc. DIN ISO 1502



ORDER-CODE →		LD-4H	GD-4H	AD-4H	LD-LH	GD-LH	AD-LH	LD-6G-LH			
d	P mm	4H Grenzlehrdorn Plug gauge	4H Gutlehrdorn GO plug gauge	4H Ausschusslehrdorn NOT GO plug gauge	6H links Grenzlehrdorn left hand Plug gauge	6H links Gutlehrdorn left hand GO plug gauge	6H links Ausschusslehrdorn left hand NOT GO plug gauge	6G links Grenzlehrdorn left hand Plug gauge			
↓	↓										
		Art.-Nr.	€	Art.-Nr.	€	Art.-Nr.	€	Art.-Nr.	€	Art.-Nr.	€
M 108	1,5										
M 110	1,5										
M 112	1,5										
M 115	1,5										
M 118	1,5										
M 120	1,5										
M 122	1,5										
M 125	1,5										
M 128	1,5										
M 130	1,5										
M 132	1,5										
M 135	1,5										
M 138	1,5										
M 140	1,5										
M 142	1,5										
M 145	1,5										
M 148	1,5										
M 150	1,5										
M 18	2	517377	91,90			516775	85,30			517247	106,00
M 20	2	517040	95,20			511926	88,30			517248	109,00
M 22	2	511956	97,20			514641	94,40			517249	126,00
M 24	2	516786	100,00			511983	98,10			517250	128,00
M 25	2	517378	115,00			517263	115,00				
M 26	2	517379	118,00			517150	113,00				
M 27	2	512021	109,00			512023	107,00			512024	139,00
M 28	2	516919	126,00			517226	126,00				
M 30	2	512090	120,00			512092	118,00			516790	145,00
M 32	2	517380	135,00			513678	125,00				
M 33	2	513440	132,00			513963	132,00			512122	156,00
M 34	2										
M 35	2										



M
MF
MJ
EG M

G
Rc, R
Pg

UNC
UNF
UN
UNJF

NPT
NPTF

M
MF
M keg.
M taper

G
BSW
BSF
DIN 477
R, BA, Pg

UNC
UNF
UNEF
UN, UNS

NPSM
NPT
NPTF
Tr, Rd

M
MF

G
BSW
BSF
R, Pg
MF-EL

UNC, UNF
UNEF
UN, UNS
UNJC
UNJF

NPT
NPTF
Tr
EG

M
MF
MJ
EG M

G
Rc, R
Pg

UNC
UNF
UN
UNJF

NPT
NPTF

M
MF
M keg.
M taper

G
BSW
BSF
DIN 477
R, BA, Pg

UNC
UNF
UNEF
UN, UNS

NPSM
NPT
NPTF
Tr, Rd

M
MF

G
BSW
BSF
R, Pg
MF-EL

UNC, UNF
UNEF
UN, UNS
UNJC
UNJF

NPT
NPTF
Tr
EG

Präzisions-Gewindelehren

Metrisches ISO-Feingewinde DIN 13

Lehrenmaße nach DIN ISO 1502

Precision thread gauges

ISO metric fine thread DIN 13

Gauge dimensions acc. DIN ISO 1502

MF

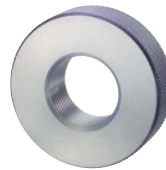
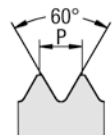

GR

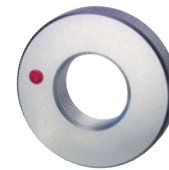

AR



ORDER-CODE →		GR	AR	GR-6e	AR-6e	GR-6h	AR-6h						
d	P mm	6g Gutlehring GO ring gauge	6g Ausschusslehring NOT GO ring gauge	6e Gutlehring GO ring gauge	6e Ausschusslehring NOT GO ring gauge	6h Gutlehring GO ring gauge	6h Ausschusslehring NOT GO ring gauge						
↓	↓												
		Art.-Nr.	€	Art.-Nr.	€	Art.-Nr.	€	Art.-Nr.	€	Art.-Nr.	€		
M 108	1,5	501491	377,00	520171	377,00								
M 110	1,5	501509	346,00	503404	346,00								
M 112	1,5	501511	421,00	500217	421,00								
M 115	1,5	520161	427,00	520172	427,00								
M 118	1,5	520162	464,00	520173	464,00								
M 120	1,5	501554	452,00	520174	452,00								
M 122	1,5	501556	464,00	500261	464,00								
M 125	1,5	504424	482,00	504425	482,00								
M 128	1,5	504216	524,00	504426	524,00								
M 130	1,5	504299	509,00	500273	509,00								
M 132	1,5	507817	546,00	520175	546,00								
M 135	1,5	506628	547,00	505452	547,00								
M 138	1,5	520163	565,00	520176	565,00								
M 140	1,5	505888	577,00	520177	577,00								
M 142	1,5	540441	585,00	520178	585,00								
M 145	1,5	520165	593,00	520179	593,00								
M 148	1,5	520168	610,00	520180	610,00								
M 150	1,5	520169	610,00	520181	610,00								
M 18	2	501686	76,30	500394	76,30	502958	87,70	502959	87,70	501687	96,10	500395	96,10
M 20	2	501770	72,00	500471	72,00	501771	87,00	500472	87,00	501772	95,10	502751	95,10
M 22	2	501803	76,60	500499	76,60	502961	92,40	502962	92,40	501805	106,00	500501	106,00
M 24	2	501836	79,90	500529	79,90	501838	96,40	500530	96,40	501839	102,00	500531	102,00
M 25	2	501855	84,80	500546	84,80	506558	107,00	506571	107,00	503307	112,00	503306	112,00
M 26	2	501867	89,00	500558	89,00	502764	105,00	504068	105,00	502766	115,00	502765	115,00
M 27	2	501884	88,40	500575	88,40	501885	104,00	500577	104,00	502854	117,00	500578	117,00
M 28	2	501898	94,00	500591	94,00	503454	117,00	503455	117,00	504017	122,00	504022	122,00
M 30	2	501947	95,50	500641	95,50	501949	112,00	500643	112,00	501950	120,00	500644	120,00
M 32	2	501971	101,00	500662	101,00	501972	128,00	500663	128,00	504018	134,00	504023	134,00
M 33	2	501984	102,00	500671	102,00	501986	120,00	500673	120,00	501987	131,00	504024	131,00
M 34	2	501996	133,00	500684	133,00								
M 35	2	502008	135,00	500694	135,00								



Präzisions-Gewindelehren

Metrisches ISO-Feingewinde DIN 13

Lehrenmaße nach DIN ISO 1502

Precision thread gauges

ISO metric fine thread DIN 13

Gauge dimensions acc. DIN ISO 1502

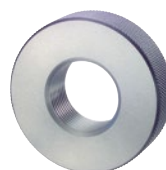

GR

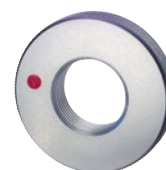

AR



ORDER-CODE →		GR-4h	AR-4h	GR-LH	AR-LH				
d	P mm	4h Gutlehring GO ring gauge	4h Ausschusslehring NOT GO ring gauge	6g links Gutlehring left hand GO ring gauge	6g links Ausschusslehring left hand NOT GO ring gauge				
↓	↓								
		Art.-Nr.	€	Art.-Nr.	€	Art.-Nr.	€	Art.-Nr.	€
M 108	1,5								
M 110	1,5								
M 112	1,5								
M 115	1,5								
M 118	1,5								
M 120	1,5								
M 122	1,5								
M 125	1,5								
M 128	1,5								
M 130	1,5								
M 132	1,5								
M 135	1,5								
M 138	1,5								
M 140	1,5								
M 142	1,5								
M 145	1,5								
M 148	1,5								
M 150	1,5								
M 18	2	504064	101,00	504012	101,00	505597	96,10	505458	96,10
M 20	2	504065	99,70	504013	99,70	501773	95,10	500473	95,10
M 22	2	501804	101,00	500500	101,00	504058	101,00	504061	101,00
M 24	2	501837	106,00	502733	106,00	501840	102,00	500532	102,00
M 25	2	506543	112,00	506271	112,00	506521	117,00	505473	117,00
M 26	2	506544	115,00	506272	115,00	506522	121,00	505474	121,00
M 27	2	503639	117,00	500576	117,00	501886	117,00	500579	117,00
M 28	2	506545	128,00	506273	128,00	506523	128,00	506530	128,00
M 30	2	501948	123,00	500642	123,00	501951	120,00	500645	120,00
M 32	2	506546	140,00	506274	140,00	503328	134,00	503326	134,00
M 33	2	501985	135,00	500672	135,00	503083	131,00	500674	131,00
M 34	2								
M 35	2								



M
MF
MJ
EG M

G
Rc, R
Pg

UNC
UNF
UN
UNJF

NPT
NPTF

M
MF
M keg.
M taper

G
BSW
BSF
DIN 477
R, BA, Pg

UNC
UNF
UNEF
UN, UNS

NPSM
NPT
NPTF
Tr, Rd

M
MF

G
BSW
BSF
R, Pg
MF-EL

UNC, UNF
UNEF
UN, UNS
UNJC
UNJF

NPT
NPTF
Tr
EG

Präzisions-Gewindelehren

Metrisches ISO-Feingewinde DIN 13

Lehrenmaße nach DIN ISO 1502

Precision thread gauges

ISO metric fine thread DIN 13

Gauge dimensions acc. DIN ISO 1502

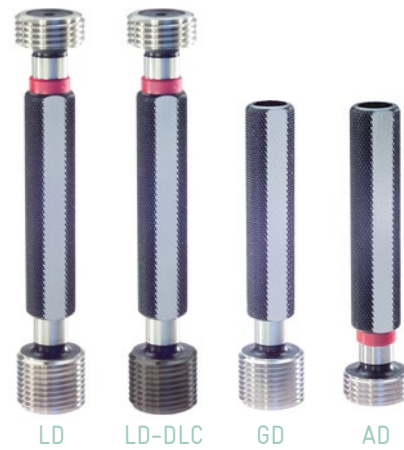

MF

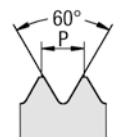

ORDER-CODE →		LD	GD	AD	LD-6G	GD-6G	AD-6G	LD-DLC			
d	P mm	6H Grenzlehrdorn Plug gauge	6H Gutlehrdorn GO plug gauge	6H Ausschusslehrdorn NOT GO plug gauge	6G Grenzlehrdorn Plug gauge	6G Gutlehrdorn GO plug gauge	6G Ausschusslehrdorn NOT GO plug gauge	6H Grenzlehrdorn GD: DLC-Härte HV 0,05 > 5000 Plug gauge GO: DLC hardness HV 0.05 > 5000			
↓	↓										
		Art.-Nr.	€	Art.-Nr.	€	Art.-Nr.	€	Art.-Nr.	€		
M 36	2	512153	108,00			512154	129,00				
M 38	2	512165	118,00			521113	149,00				
M 39	2	512173	121,00			512174	149,00				
M 40	2	512216	126,00			513465	155,00				
M 42	2			511116	74,60	510389	68,70	511117	91,30	510390	84,00
M 45	2			511128	79,10	510400	73,20	516705	96,80	516609	89,60
M 48	2			511144	83,80	510415	77,30	511146	106,00	510416	97,30
M 50	2			511169	86,40	510439	80,00	526427	109,00	524417	101,00
M 52	2			511178	89,80	510448	83,10	514336	113,00	510449	105,00
M 55	2			511186	95,70	510456	88,40	513205	126,00	513206	117,00
M 56	2			511191	97,40	510461	90,40	526428	123,00	524418	114,00
M 58	2			511196	101,00	510467	93,00	526429	124,00	524419	114,00
M 60	2			511214	105,00	510484	96,80	513539	129,00	513540	118,00
M 62	2			511217	108,00	510489	99,90	526523	143,00	524475	132,00
M 64	2			511220	112,00	510494	104,00	523683	148,00	523684	137,00
M 65	2			511224	116,00	510497	107,00	526515	146,00	526516	135,00
M 68	2			511230	119,00	510502	110,00	526517	150,00	526518	139,00
M 70	2			511241	123,00	510509	113,00	516911	155,00	513441	143,00
M 72	2			511244	127,00	510512	117,00	518205	160,00	524469	148,00
M 75	2			511248	132,00	510514	122,00	526519	166,00	524470	153,00
M 76	2			511251	141,00	510516	130,00	518362	173,00	517395	159,00
M 78	2			511253	144,00	510518	133,00	517903	181,00	517904	167,00
M 80	2			511275	141,00	510544	131,00	511276	177,00	519864	164,00
M 82	2			511279	151,00	516627	140,00	526520	191,00	524471	176,00
M 85	2			511281	151,00	510548	140,00	513955	185,00	517009	171,00
M 88	2			511284	166,00	510552	153,00				
M 90	2			511297	158,00	510562	147,00				
M 92	2			511301	162,00	510565	150,00				
M 95	2			511303	166,00	510567	153,00				
M 98	2			511304	171,00	510568	158,00				
M 100	2			510838	176,00	510090	162,00				

Präzisions-Gewindelehren

Metrisches ISO-Feingewinde DIN 13

Lehrenmaße nach DIN ISO 1502

Precision thread gauges

ISO metric fine thread DIN 13

Gauge dimensions acc. DIN ISO 1502



ORDER-CODE →		LD-4H	GD-4H	AD-4H	LD-LH	GD-LH	AD-LH	LD-6G-LH				
d	P mm	4H Grenzlehndorn Plug gauge	4H Gutlehdorn GO plug gauge	4H Ausschusslehndorn NOT GO plug gauge	6H links Grenzlehndorn left hand Plug gauge	6H links Gutlehdorn left hand GO plug gauge	6H links Ausschusslehndorn left hand NOT GO plug gauge	6G links Grenzlehndorn left hand Plug gauge				
↓	↓											
		Art.-Nr.	€	Art.-Nr.	€	Art.-Nr.	€	Art.-Nr.	€	Art.-Nr.	€	
M 36	2	514345	142,00			512155	135,00			514656	168,00	
M 38	2	517381	152,00			517264	152,00					
M 39	2	517382	160,00			514232	160,00			517251	199,00	
M 40	2	517383	167,00			514216	159,00					
M 42	2			515066	98,70	517118	90,80		514230	95,90	514231	88,20
M 45	2			515067	105,00	515068	96,90		511129	102,00	510401	94,10
M 48	2			511145	111,00	516610	102,00		511147	108,00	510417	99,40
M 50	2			526430	120,00	524420	111,00		511170	111,00	510440	103,00
M 52	2			514105	119,00	515069	110,00		514132	119,00	514133	110,00
M 55	2			517063	133,00	517064	122,00		516709	127,00	517375	117,00
M 56	2			526431	135,00	524421	125,00		514712	125,00	514714	116,00
M 58	2			526432	140,00	524422	129,00		516711	140,00	516617	129,00
M 60	2			526433	139,00	524423	128,00		514713	132,00	510486	122,00
M 62	2								517374	143,00	517376	132,00
M 64	2								511221	148,00	517845	137,00
M 65	2								516714	153,00	516619	141,00
M 68	2								516862	157,00	516621	146,00
M 70	2								513474	163,00	516918	150,00
M 72	2								523819	164,00	523820	151,00
M 75	2								516718	170,00	516922	156,00
M 76	2								516076	187,00	516077	172,00
M 78	2								526521	190,00	524472	176,00
M 80	2								516719	181,00	516625	168,00
M 82	2								517699	200,00	524473	185,00
M 85	2								516721	191,00	516628	176,00
M 88	2											
M 90	2											
M 92	2											
M 95	2											
M 98	2											
M 100	2											

M
MF
MJ
EG M

G
Rc, R
Pg

UNC
UNF
UN
UNJF

NPT
NPTF

M
MF
M keg.
M taper

G
BSW
BSF
DIN 477
R, BA, Pg

UNC
UNF
UNEF
UN, UNS

NPSM
NPT
NPTF
Tr, Rd

M
MF

G
BSW
BSF
R, Pg
MF-EL

UNC, UNF
UNEF
UN, UNS
UNJC
UNJF

NPT
NPTF
Tr
EG



Präzisions-Gewindelehren

Metrisches ISO-Feingewinde DIN 13

Lehrenmaße nach DIN ISO 1502

Precision thread gauges

ISO metric fine thread DIN 13

Gauge dimensions acc. DIN ISO 1502

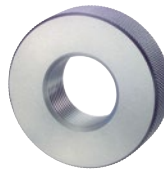

GR

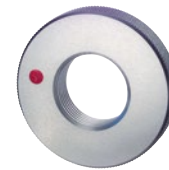

AR



ORDER-CODE →		GR	AR	GR-6e	AR-6e	GR-6h	AR-6h		
d	P mm	6g Gutlehring GO ring gauge	6g Ausschusslehring NOT GO ring gauge	6e Gutlehring GO ring gauge	6e Ausschusslehring NOT GO ring gauge	6h Gutlehring GO ring gauge	6h Ausschusslehring NOT GO ring gauge		
↓	↓								
		Art.-Nr.	€	Art.-Nr.	€	Art.-Nr.	€	Art.-Nr.	€
M 36	2	502023	109,00	500705	109,00	502024	128,00	500706	128,00
M 38	2	502038	117,00	500722	117,00	505959	142,00	505960	142,00
M 39	2	502045	119,00	500731	119,00	506559	151,00	506572	151,00
M 40	2	502086	125,00	500768	125,00	505624	158,00	505489	158,00
M 42	2	502100	127,00	500782	127,00	505627	149,00	505490	149,00
M 45	2	502116	134,00	500797	134,00	502117	157,00	500798	157,00
M 48	2	502133	141,00	500815	141,00	502134	171,00	500816	171,00
M 50	2	502173	147,00	500857	147,00	503081	177,00	505770	177,00
M 52	2	502181	153,00	500864	153,00	505641	185,00	500867	185,00
M 55	2	502196	163,00	500875	163,00	506560	206,00	506573	206,00
M 56	2	502205	166,00	500883	166,00	505645	209,00	500885	209,00
M 58	2	502212	170,00	500892	170,00	506561	215,00	506533	215,00
M 60	2	502248	177,00	500927	177,00	502249	207,00	500928	207,00
M 62	2	502255	186,00	500934	186,00	506562	221,00	506534	221,00
M 64	2	502259	189,00	500937	189,00	506563	228,00	506535	228,00
M 65	2	502264	191,00	500943	191,00	506564	243,00	506536	243,00
M 68	2	502270	200,00	500946	200,00				
M 70	2	502287	206,00	500965	206,00				
M 72	2	502290	246,00	500968	246,00				
M 75	2	502295	223,00	500974	223,00				
M 76	2	502297	257,00	500977	257,00				
M 78	2	502300	261,00	500979	261,00				
M 80	2	502335	242,00	501015	242,00				
M 82	2	502339	275,00	505531	275,00				
M 85	2	502342	261,00	502736	261,00				
M 88	2	502346	301,00	501023	301,00				
M 90	2	502363	281,00	501038	281,00				
M 92	2	502369	293,00	501042	293,00				
M 95	2	502371	299,00	501044	299,00				
M 98	2	502372	310,00	501045	310,00				
M 100	2	501486	319,00	500195	319,00				



Präzisions-Gewindelehren

Metrisches ISO-Feingewinde DIN 13

Lehrenmaße nach DIN ISO 1502

Precision thread gauges

ISO metric fine thread DIN 13

Gauge dimensions acc. DIN ISO 1502

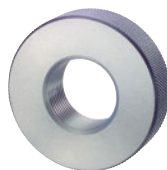

GR

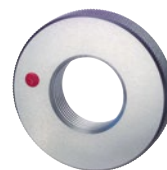

AR



ORDER-CODE →		GR-4h		AR-4h		GR-LH		AR-LH	
d	P mm	4h Gutlehring GO ring gauge		4h Ausschusslehring NOT GO ring gauge		6g links Gutlehring left hand GO ring gauge		6g links Ausschusslehring left hand NOT GO ring gauge	
↓	↓								
		Art.-Nr.	€	Art.-Nr.	€	Art.-Nr.	€	Art.-Nr.	€
M 36	2	504066	145,00	504014	145,00	502026	138,00	500707	138,00
M 38	2	506547	163,00	506275	163,00	505618	155,00	505481	155,00
M 39	2	504067	158,00	504015	158,00	505620	158,00	500732	158,00
M 40	2	506548	173,00	506276	173,00	505625	165,00	500769	165,00
M 42	2	502101	168,00	500783	168,00	504059	163,00	504062	163,00
M 45	2	505628	177,00	505934	177,00	502118	177,00	500799	177,00
M 48	2	503809	187,00	504016	187,00	505630	182,00	500817	182,00
M 50	2	506549	204,00	506277	204,00	505637	189,00	500858	189,00
M 52	2	502183	197,00	500866	197,00	502184	203,00	500868	203,00
M 55	2	502197	209,00	500876	209,00	505644	209,00	505504	209,00
M 56	2	502896	219,00	500884	219,00	502206	213,00	500886	213,00
M 58	2	506550	235,00	506278	235,00	505646	235,00	500893	235,00
M 60	2	505651	223,00	505804	223,00	502250	223,00	500929	223,00
M 62	2	506551	235,00	506279	235,00	506524	242,00	506531	242,00
M 64	2	502260	250,00	500938	250,00	505654	243,00	505512	243,00
M 65	2	506552	247,00	506280	247,00	503769	255,00	506532	255,00
M 68	2	506553	265,00	506281	265,00	505723	265,00	505516	265,00
M 70	2	506554	265,00	506282	265,00	505794	265,00	505520	265,00
M 72	2					503748	325,00	543591	325,00
M 75	2					505661	288,00	505523	288,00
M 76	2					504365	335,00	505223	335,00
M 78	2					547291	347,00	540981	347,00
M 80	2					505668	321,00	505530	321,00
M 82	2					543164	357,00	543165	357,00
M 85	2					505669	337,00	505533	337,00
M 88	2								
M 90	2								
M 92	2								
M 95	2								
M 98	2								
M 100	2								



Präzisions-Gewindelehren

Metrisches ISO-Feingewinde DIN 13

Lehrenmaße nach DIN ISO 1502

Precision thread gauges

ISO metric fine thread DIN 13

Gauge dimensions acc. DIN ISO 1502

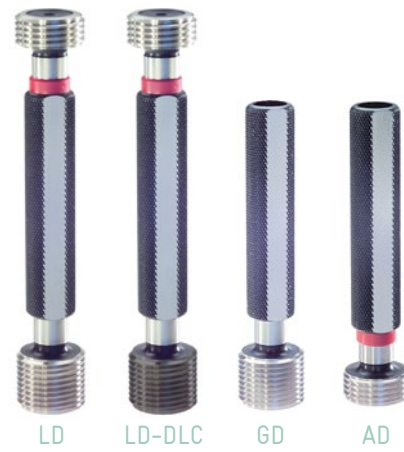

MF

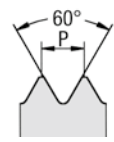

ORDER-CODE →		LD	GD	AD	LD-6G	GD-6G	AD-6G	LD-DLC
d	P mm	6H Grenzlehrdorn Plug gauge	6H Gutlehrdorn GO plug gauge	6H Ausschusslehrdorn NOT GO plug gauge	6G Grenzlehrdorn Plug gauge	6G Gutlehrdorn GO plug gauge	6G Ausschusslehrdorn NOT GO plug gauge	6H Grenzlehrdorn GD: DLC-Härte HV 0,05 > 5000 Plug gauge GO: DLC hardness HV 0.05 > 5000
↓	↓							
		Art.-Nr. €	Art.-Nr. €	Art.-Nr. €	Art.-Nr. €	Art.-Nr. €	Art.-Nr. €	Art.-Nr. €
M 102	2		526463 220,00	516575 198,00				
M 105	2		510842 185,00	510093 171,00				
M 108	2		520069 231,00	510095 208,00				
M 110	2		510851 194,00	510103 179,00				
M 112	2		516663 237,00	516577 214,00				
M 115	2		510854 240,00	513918 216,00				
M 118	2		518905 252,00	519513 227,00				
M 120	2		510872 250,00	510122 225,00				
M 122	2		510873 270,00	516578 242,00				
M 125	2		515033 262,00	514978 236,00				
M 128	2		514954 270,00	520077 242,00				
M 130	2		514063 273,00	514719 246,00				
M 132	2		510880 278,00	510129 250,00				
M 135	2		510881 284,00	520078 256,00				
M 138	2		520071 292,00	520079 262,00				
M 140	2		510897 295,00	518882 265,00				
M 142	2		516669 299,00	520081 270,00				
M 145	2		518907 307,00	519516 275,00				
M 148	2		516670 313,00	520083 282,00				
M 150	2		510904 318,00	510149 286,00				
M 30	3	512094 112,00						
M 33	3	512124 117,00						
M 36	3	512156 119,00						
M 39	3	512175 146,00						
M 40	3	512217 162,00						
M 42	3		511118 87,40	510391 80,60				
M 45	3		511130 92,30	510402 85,10				
M 48	3		511148 97,40	510418 89,80				
M 50	3		513534 130,00	510441 117,00				
M 52	3		511179 105,00	510450 96,90				
M 55	3		516710 129,00	516616 116,00				

Präzisions-Gewindelehren

Metrisches ISO-Feingewinde DIN 13

Lehrenmaße nach DIN ISO 1502

Precision thread gauges

ISO metric fine thread DIN 13

Gauge dimensions acc. DIN ISO 1502



ORDER-CODE →		LD-4H	GD-4H	AD-4H	LD-LH	GD-LH	AD-LH	LD-6G-LH		
d	P mm	4H Grenzlehrdorn Plug gauge	4H Gutlehrdorn GO plug gauge	4H Ausschusslehrdorn NOT GO plug gauge	6H links Grenzlehrdorn left hand Plug gauge	6H links Gutlehrdorn left hand GO plug gauge	6H links Ausschusslehrdorn left hand NOT GO plug gauge	6G links Grenzlehrdorn left hand Plug gauge		
↓	↓									
		Art.-Nr. €	Art.-Nr. €	Art.-Nr. €	Art.-Nr. €	Art.-Nr. €	Art.-Nr. €	Art.-Nr. €		
M 102	2									
M 105	2									
M 108	2									
M 110	2									
M 112	2									
M 115	2									
M 118	2									
M 120	2									
M 122	2									
M 125	2									
M 128	2									
M 130	2									
M 132	2									
M 135	2									
M 138	2									
M 140	2									
M 142	2									
M 145	2									
M 148	2									
M 150	2									
M 30	3				517265	148,00				
M 33	3				514642	147,00				
M 36	3				513409	150,00				
M 39	3				517266	178,00				
M 40	3									
M 42	3						514248	112,00	514249	104,00
M 45	3						517020	122,00	517303	113,00
M 48	3						513874	129,00	513875	119,00
M 50	3									
M 52	3						517301	146,00	517304	134,00
M 55	3									

M
MF
MJ
EG M

G
Rc, R
Pg

UNC
UNF
UN
UNJF

NPT
NPTF

M
MF
M keg.
M taper

G
BSW
BSF
DIN 477
R, BA, Pg

UNC
UNF
UNEF
UN, UNS

NPSM
NPT
NPTF
Tr, Rd

M
MF

G
BSW
BSF
R, Pg
MF-EL

UNC, UNF
UNEF
UN, UNS
UNJC
UNJF

NPT
NPTF
Tr
EG



M
MF
MJ
EG M

G
Rc, R
Pg

UNC
UNF
UN
UNJF

NPT
NPTF

M
MF
M keg.
M taper

G
BSW
BSF
DIN 477
R, BA, Pg

UNC
UNF
UNEF
UN, UNS

NPSM
NPT
NPTF
Tr, Rd

M
MF

G
BSW
BSF
R, Pg
MF-EL

UNC, UNF
UNEF
UN, UNS
UNJC
UNJF

NPT
NPTF
Tr
EG

Präzisions-Gewindelehren

Metrisches ISO-Feingewinde DIN 13

Lehrenmaße nach DIN ISO 1502

Precision thread gauges

ISO metric fine thread DIN 13

Gauge dimensions acc. DIN ISO 1502

MF

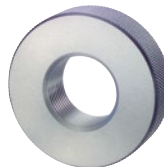
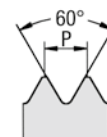

GR

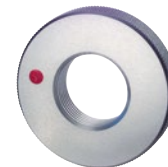

AR



ORDER-CODE →		GR	AR	GR-6e	AR-6e	GR-6h	AR-6h				
d	P mm	6g Gutlehring GO ring gauge	6g Ausschusslehring NOT GO ring gauge	6e Gutlehring GO ring gauge	6e Ausschusslehring NOT GO ring gauge	6h Gutlehring GO ring gauge	6h Ausschusslehring NOT GO ring gauge				
↓	↓										
		Art.-Nr.	€	Art.-Nr.	€	Art.-Nr.	€	Art.-Nr.	€	Art.-Nr.	€
M 102	2	520182	346,00	500198	346,00						
M 105	2	501489	335,00	500200	335,00						
M 108	2	520183	370,00	520198	370,00						
M 110	2	501510	354,00	500216	354,00						
M 112	2	520184	425,00	520199	425,00						
M 115	2	503088	434,00	504354	434,00						
M 118	2	503609	450,00	520200	450,00						
M 120	2	501555	461,00	500260	461,00						
M 122	2	505580	496,00	505450	496,00						
M 125	2	501557	491,00	504256	491,00						
M 128	2	506819	519,00	520201	519,00						
M 130	2	501568	519,00	500274	519,00						
M 132	2	501569	540,00	500275	540,00						
M 135	2	501570	546,00	520202	546,00						
M 138	2	520185	591,00	520203	591,00						
M 140	2	501607	575,00	520204	575,00						
M 142	2	505588	585,00	520205	585,00						
M 145	2	505589	604,00	500311	604,00						
M 148	2	507441	621,00	520206	621,00						
M 150	2	503523	633,00	520207	633,00						
M 30	3	501952	108,00	503223	108,00						
M 33	3	501988	120,00	500675	120,00						
M 36	3	502027	120,00	500708	120,00						
M 39	3	502046	126,00	500733	126,00						
M 40	3	502088	170,00	500770	170,00						
M 42	3	502102	135,00	500785	135,00						
M 45	3	502119	143,00	500800	143,00						
M 48	3	502135	151,00	500818	151,00						
M 50	3	502174	200,00	503216	200,00						
M 52	3	502185	162,00	500869	162,00						
M 55	3	502198	200,00	505505	200,00						



Präzisions-Gewindelehren

Metrisches ISO-Feingewinde DIN 13

Lehrenmaße nach DIN ISO 1502

Precision thread gauges

ISO metric fine thread DIN 13

Gauge dimensions acc. DIN ISO 1502

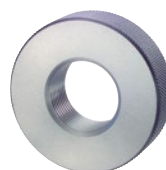

GR

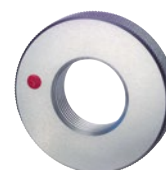

AR



ORDER-CODE →		GR-4h	AR-4h	GR-LH	AR-LH		
d	P mm	4h Gutlehring GO ring gauge	4h Ausschusslehring NOT GO ring gauge	6g links Gutlehring left hand GO ring gauge	6g links Ausschusslehring left hand NOT GO ring gauge		
↓	↓						
		Art.-Nr.	€	Art.-Nr.	€	Art.-Nr.	€
M 102	2						
M 105	2						
M 108	2						
M 110	2						
M 112	2						
M 115	2						
M 118	2						
M 120	2						
M 122	2						
M 125	2						
M 128	2						
M 130	2						
M 132	2						
M 135	2						
M 138	2						
M 140	2						
M 142	2						
M 145	2						
M 148	2						
M 150	2						
M 30	3					506308	146,00
M 33	3					506309	159,00
M 36	3					502974	155,00
M 39	3					505621	163,00
M 40	3						
M 42	3					504029	174,00
M 45	3					506310	189,00
M 48	3					503406	193,00
M 50	3						
M 52	3					503830	215,00
M 55	3						

M
MF
MJ
EG M

G
Rc, R
Pg

UNC
UNF
UN
UNJF

NPT
NPTF

M
MF
M keg.
M taper

G
BSW
BSF
DIN 477
R, BA, Pg

UNC
UNF
UNEF
UN, UNS

NPSM
NPT
NPTF
Tr, Rd

M
MF

G
BSW
BSF
R, Pg
MF-EL

UNC, UNF
UNEF
UN, UNS
UNJC
UNJF

NPT
NPTF
Tr
EG



Präzisions-Gewindelehren

Metrisches ISO-Feingewinde DIN 13

Lehrenmaße nach DIN ISO 1502

Precision thread gauges

ISO metric fine thread DIN 13

Gauge dimensions acc. DIN ISO 1502

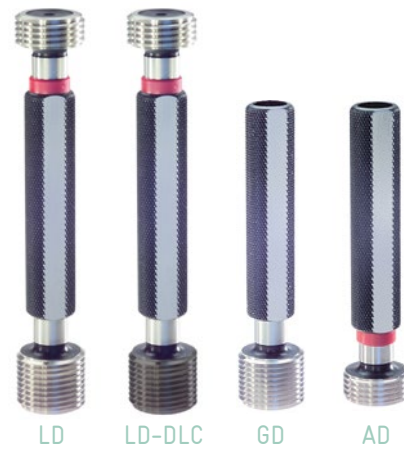

MF

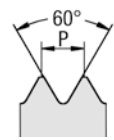

ORDER-CODE →		LD	GD	AD	LD-6G	GD-6G	AD-6G	LD-DLC
d	P mm	6H Grenzlehrdorn Plug gauge	6H Gutlehrdorn GO plug gauge	6H Ausschusslehrdorn NOT GO plug gauge	6G Grenzlehrdorn Plug gauge	6G Gutlehrdorn GO plug gauge	6G Ausschusslehrdorn NOT GO plug gauge	6H Grenzlehrdorn GD: DLC-Härte HV 0,05 > 5000 Plug gauge GO: DLC hardness HV 0.05 > 5000
↓	↓							
		Art.-Nr. €	Art.-Nr. €	Art.-Nr. €	Art.-Nr. €	Art.-Nr. €	Art.-Nr. €	Art.-Nr. €
M 56	3		511192 128,00	510462 115,00				
M 58	3		511197 135,00	510468 122,00				
M 60	3		513225 138,00	513226 124,00				
M 62	3		513529 145,00	513528 130,00				
M 64	3		513530 145,00	513531 130,00				
M 65	3		511225 147,00	510498 132,00				
M 68	3		511231 158,00	513536 143,00				
M 70	3		520084 160,00	520102 144,00				
M 72	3		513125 164,00	513126 147,00				
M 75	3		516235 172,00	510515 155,00				
M 76	3		520085 174,00	520103 156,00				
M 80	3		516720 182,00	516626 164,00				
M 85	3		511282 194,00	510549 175,00				
M 90	3		511298 206,00	510563 185,00				
M 95	3		516856 218,00	516857 196,00				
M 100	3		510839 228,00	510091 206,00				
M 105	3		517703 240,00	517741 216,00				
M 110	3		510852 250,00	510104 226,00				
M 115	3		517089 263,00	517090 237,00				
M 120	3		516880 274,00	520104 247,00				
M 125	3		510874 285,00	510123 257,00				
M 130	3		513756 297,00	513757 268,00				
M 135	3		516891 310,00	516892 280,00				
M 140	3		510898 321,00	510145 290,00				
M 145	3		512978 335,00	512979 301,00				
M 150	3		520086 347,00	520105 312,00				
M 52	4		513507 122,00	513506 110,00				
M 55	4		516924 139,00	516925 125,00				
M 56	4		511193 128,00	510463 115,00				
M 58	4		520087 140,00	520106 126,00				
M 60	4		511215 138,00	510487 124,00				



Präzisions-Gewindelehren

Metrisches ISO-Feingewinde DIN 13

Lehrenmaße nach DIN ISO 1502

Precision thread gauges

ISO metric fine thread DIN 13

Gauge dimensions acc. DIN ISO 1502

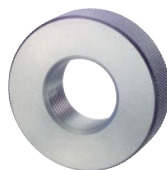

GR

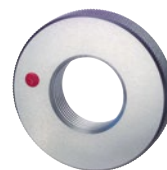

AR



ORDER-CODE →		GR	AR	GR-6e	AR-6e	GR-6h	AR-6h				
d	P mm	6g Gutlehring GO ring gauge	6g Ausschusslehring NOT GO ring gauge	6e Gutlehring GO ring gauge	6e Ausschusslehring NOT GO ring gauge	6h Gutlehring GO ring gauge	6h Ausschusslehring NOT GO ring gauge				
↓	↓										
		Art.-Nr.	€	Art.-Nr.	€	Art.-Nr.	€	Art.-Nr.	€	Art.-Nr.	€
M 56	3	502207	200,00	500887	200,00						
M 58	3	502213	208,00	500894	208,00						
M 60	3	502251	214,00	500930	214,00						
M 62	3	503206	225,00	503205	225,00						
M 64	3	502261	227,00	500939	227,00						
M 65	3	502265	230,00	520208	230,00						
M 68	3	503202	239,00	500947	239,00						
M 70	3	504108	246,00	520209	246,00						
M 72	3	502910	251,00	502909	251,00						
M 75	3	503048	275,00	500975	275,00						
M 76	3	503725	280,00	505524	280,00						
M 80	3	502336	298,00	520210	298,00						
M 85	3	503743	321,00	503744	321,00						
M 90	3	502365	344,00	501040	344,00						
M 95	3	520186	380,00	520211	380,00						
M 100	3	505574	392,00	507833	392,00						
M 105	3	501490	425,00	505440	425,00						
M 110	3	505576	449,00	505445	449,00						
M 115	3	503745	479,00	520212	479,00						
M 120	3	502897	509,00	505449	509,00						
M 125	3	503460	541,00	540068	541,00						
M 130	3	507147	570,00	520214	570,00						
M 135	3	501571	602,00	500276	602,00						
M 140	3	503742	632,00	504205	632,00						
M 145	3	501608	672,00	500312	672,00						
M 150	3	520187	693,00	520215	693,00						
M 52	4	503164	198,00	503177	198,00						
M 55	4	505798	207,00	505799	207,00						
M 56	4	502208	211,00	500888	211,00						
M 58	4	520188	224,00	520216	224,00						
M 60	4	502252	226,00	503217	226,00						



M
MF
MJ
EG M

G
Rc, R
Pg

UNC
UNF
UN
UNJF

NPT
NPTF

M
MF
M keg.
M taper

G
BSW
BSF
DIN 477
R, BA, Pg

UNC
UNF
UNEF
UN, UNS

NPSM
NPT
NPTF
Tr, Rd

M
MF

G
BSW
BSF
R, Pg
MF-EL

UNC, UNF
UNEF
UN, UNS
UNJC
UNJF

NPT
NPTF
Tr
EG

Präzisions-Gewindelehren

Metrisches ISO-Feingewinde DIN 13

Lehrenmaße nach DIN ISO 1502

Precision thread gauges

ISO metric fine thread DIN 13

Gauge dimensions acc. DIN ISO 1502

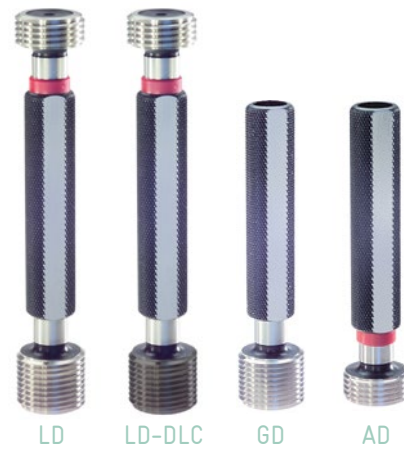

MF

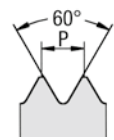

ORDER-CODE →		LD	GD	AD	LD-6G	GD-6G	AD-6G	LD-DLC
d	P mm	6H Grenzlehrdorn Plug gauge	6H Gutlehrdorn GO plug gauge	6H Ausschusslehrdorn NOT GO plug gauge	6G Grenzlehrdorn Plug gauge	6G Gutlehrdorn GO plug gauge	6G Ausschusslehrdorn NOT GO plug gauge	6H Grenzlehrdorn GD: DLC-Härte HV 0,05 > 5000 Plug gauge GO: DLC hardness HV 0.05 > 5000
↓	↓							
		Art.-Nr. €	Art.-Nr. €	Art.-Nr. €	Art.-Nr. €	Art.-Nr. €	Art.-Nr. €	Art.-Nr. €
M 62	4		513532 142,00	510490 128,00				
M 64	4		511222 145,00	510495 130,00				
M 65	4		520088 147,00	514098 132,00				
M 68	4		518916 155,00	520107 140,00				
M 70	4		514296 160,00	517405 144,00				
M 72	4		511245 164,00	518830 147,00				
M 75	4		520090 172,00	520109 155,00				
M 76	4		517001 174,00	520110 156,00				
M 80	4		511277 182,00	510545 164,00				
M 85	4		511283 194,00	510550 175,00				
M 90	4		516724 206,00	520111 185,00				
M 95	4		517005 218,00	520112 196,00				
M 100	4		514222 228,00	517074 206,00				
M 105	4		514223 240,00	516044 216,00				
M 110	4		513658 251,00	513659 226,00				
M 115	4		520091 263,00	520113 237,00				
M 120	4		517002 274,00	517003 247,00				
M 125	4		516665 285,00	520114 257,00				
M 130	4		520092 297,00	520115 268,00				
M 135	4		520093 310,00	520116 280,00				
M 140	4		520094 321,00	520117 290,00				
M 145	4		520095 335,00	520118 301,00				
M 150	4		517006 347,00	520119 312,00				
M 70	6		520096 175,00	520120 157,00				
M 72	6		511242 178,00	510510 160,00				
M 76	6		518716 183,00	520122 165,00				
M 80	6		514186 194,00	510542 175,00				
M 85	6		515444 208,00	520123 187,00				
M 90	6		511299 228,00	516631 199,00				
M 95	6		520100 235,00	520124 211,00				
M 100	6		520101 248,00	520125 223,00				



Präzisions-Gewindelehren

Metrisches ISO-Feingewinde DIN 13

Lehrenmaße nach DIN ISO 1502

Precision thread gauges

ISO metric fine thread DIN 13

Gauge dimensions acc. DIN ISO 1502

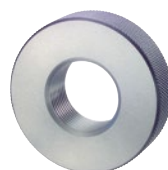

GR

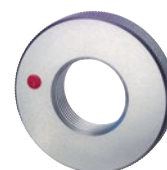

AR



ORDER-CODE →		GR	AR	GR-6e	AR-6e	GR-6h	AR-6h	
d	P mm	6g Gutlehring GO ring gauge	6g Ausschusslehring NOT GO ring gauge	6e Gutlehring GO ring gauge	6e Ausschusslehring NOT GO ring gauge	6h Gutlehring GO ring gauge	6h Ausschusslehring NOT GO ring gauge	
↓	↓							
		Art.-Nr. €	Art.-Nr. €	Art.-Nr. €	Art.-Nr. €	Art.-Nr. €	Art.-Nr. €	
M 62	4	520189 244,00	520217 244,00					
M 64	4	502262 240,00	500940 240,00					
M 65	4	520190 244,00	520218 244,00					
M 68	4	503214 252,00	503215 252,00					
M 70	4	505963 259,00	505964 259,00					
M 72	4	502291 265,00	500969 265,00					
M 75	4	520191 284,00	520219 284,00					
M 76	4	503099 287,00	505525 287,00					
M 80	4	502337 307,00	501016 307,00					
M 85	4	502343 331,00	501020 331,00					
M 90	4	502366 354,00	505536 354,00					
M 95	4	505952 377,00	520220 377,00					
M 100	4	502887 401,00	500196 401,00					
M 105	4	505953 425,00	520221 425,00					
M 110	4	503568 449,00	543521 449,00					
M 115	4	520192 479,00	520223 479,00					
M 120	4	503612 509,00	520224 509,00					
M 125	4	505581 541,00	520225 541,00					
M 130	4	505584 569,00	520226 569,00					
M 135	4	520193 601,00	520227 601,00					
M 140	4	505974 632,00	505975 632,00					
M 145	4	520194 672,00	520228 672,00					
M 150	4	505956 693,00	520229 693,00					
M 70	6	505659 292,00	505521 292,00					
M 72	6	520195 298,00	520230 298,00					
M 76	6	520196 314,00	520231 314,00					
M 80	6	503354 332,00	501017 332,00					
M 85	6	504273 360,00	507014 360,00					
M 90	6	502367 386,00	520232 386,00					
M 95	6	520197 414,00	520233 414,00					
M 100	6	503517 443,00	503518 443,00					



M
MF
MJ
EG M

G
Rc, R
Pg

UNC
UNF
UN
UNJF

NPT
NPTF

M
MF
M keg.
M taper

G
BSW
BSF
DIN 477
R, BA, Pg

UNC
UNF
UNEF
UN, UNS

NPSM
NPT
NPTF
Tr, Rd

M
MF

G
BSW
BSF
R, Pg
MF-EL

UNC, UNF
UNEF
UN, UNS
UNJC
UNJF

NPT
NPTF
Tr
EG



Präzisions-Gewindelehren MultiCheck

Metrisches ISO-Feingewinde DIN 13

Lehrenmaße nach DIN ISO 1502
 Messtiefe bis 4 x D, max. 80 mm

Precision thread gauges MultiCheck
 ISO metric fine thread DIN 13
 Gauge dimensions acc.
 DIN ISO 1502
 Gauging depth up to 4 x D
 max. 80 mm



ORDER-CODE →			MCS		MCN		MCD			
Ablesegenauigkeit Accuracy of reading			0,5 mm		0,1 mm		0,01 mm			
d	P mm	Systemgröße System size	Skala 6H Scale		Nonius 6H Vernier		Systemgröße System size		Digital 6H inkl. Prüfzert. Digital readout incl. inspection certificate	
			Art.-Nr.	€	Art.-Nr.	€	Art.-Nr.	€		
M 8	1	20	590044	298,00	590274	414,00	28	590122	710,00	
M 10	1	20	590045	302,00	590277	417,00	28	590123	714,00	
M 10	1,25	20	590089	309,00	590278	426,00	28	590166	722,00	
M 12	1	25	590046	321,00	590279	446,00	35	590167	851,00	
M 12	1,25	25	590068	330,00	590280	455,00	35	590168	859,00	
M 12	1,5	25	590008	317,00	590281	442,00	35	590169	846,00	
M 14	1	25	590090	xx	590282	xx	35	590170	xx	
M 14	1,25	25	590091	xx	590283	xx	35	590171	xx	
M 14	1,5	25	590016	320,00	590284	445,00	35	590124	857,00	
M 16	1	28	590092	xx	590285	xx	35	590172	xx	
M 16	1,5	28	590011	384,00	590286	523,00	35	590173	883,00	
M 18	1	28	590093	xx	590287	xx	35	590174	xx	
M 18	1,5	28	590094	387,00	590288	527,00	35	590175	894,00	
M 20	1	36	590096	xx	590290	xx	35	590177	xx	
M 20	1,5	36	590097	xx	590291	xx	35	590178	xx	
M 22	1	36	590099	xx	590293	xx	35	590180	xx	
M 22	1,5	36	590100	xx	590294	xx	35	590181	xx	
M 24	1	36	590020	xx	590236	xx	35	590183	xx	
M 24	1,5	36	590102	xx	590296	xx	35	590184	xx	
M 30	1,5	43	590104	xx	590298	xx	35	590186	xx	

xx Preis auf Anfrage

Preise für Gutseite DLC beschichtet auf Anfrage

MultiCheck Einstelllehre € 263,- (Art.-Nr. 592010)

Abb. siehe Seite 228

Abziehset für Gewinde

Ø 8-24 € 132,-

Datenübertragung auf Anfrage

MultiCheck Digital mit integriertem Funk-Modul (MCDW) auf Anfrage

xx price on request

Prices for GO side DLC coated on request

MultiCheck setting gauge € 263,- (article no. 592010)

see figure page 228

dismantling kit for threads

Ø 8-24 € 132,-

Data transfer on request

MultiCheck digital with integrated wireless data transmission (MCDW) on request



Koordinatenmessdorne

Metrisches ISO-Feingewinde DIN 13

Ausführung: Steigungsverzug im Gewinde
Stützt sich an zwei Gewindeflanken ab

Anwendung: Bestimmung der Position und Winkligkeit eines Innengewindes mittels 3D Messmaschine

Coordinate gauge rod

ISO metric fine thread DIN 13

Specification: Pitch correction in the thread
Fitted in two thread flanks for centric mounting

Usage: Determination of position and angularity of the thread via 3D measuring machine

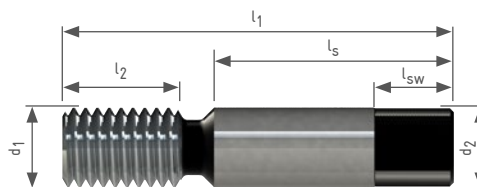

ORDER-CODE								KD	
d	P mm	d ₂	l ₁	l ₂	l _s	sw	l _{sw}	Koordinatenmessdorn Coordinate gauge rod	
↓	↓								
								Art.-Nr.	€
M 8	1	8	37	10	24	6	8	220641	241,00
M 10	1	10	43	10	30	8	10	220642	258,00
M 12	1	12	49	10	36	10	12	220229	280,00
M 12	1,5	12	55	15	36	10	12	220643	258,00
M 14	1,5	14	61	15	42	12	14	220646	274,00
M 16	1	16	61	10	48	14	16	220647	318,00
M 16	1,5	16	67	15	48	14	16	220648	285,00

Preise für weitere Gewinde auf Anfrage

Prices for other threads on request

Präzisions-Gewindelehren Whitworth-Rohrgewinde DIN EN ISO 228

Lehrenmaße nach DIN EN ISO 228-2

Precision thread gauges

Whitworth pipe thread DIN EN ISO 228
Gauge dimensions acc. DIN EN ISO 228-2



G

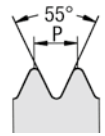

ORDER-CODE →			LD	GD	AD	LD-DLC		
d	P Gg/1" tpi	Ø d mm	Grenzlehrdorn Plug gauge	Gutlehrdorn GO plug gauge	Ausschusslehrdorn NOT GO plug gauge	Grenzlehrdorn GD: DLC-Härte HV 0,05 > 5000 Plug gauge GO: DLC hardness HV 0.05 > 5000		
↓								
			Art.-Nr.	€	Art.-Nr.	€	Art.-Nr.	€
G 1/16"	28	7,723	511577	76,80				
G 1/8"	28	9,728	511589	52,30			512727	79,10
G 1/4"	19	13,157	511584	57,50			512726	92,70
G 3/8"	19	16,662	511597	66,00			512729	112,00
G 1/2"	14	20,955	511578	75,70			512725	130,00
G 5/8"	14	22,911	511601	83,30				
G 3/4"	14	26,441	511593	87,90			512728	146,00
G 7/8"	14	30,201	511602	108,00				
G 1"	11	33,249	511573	108,00			512724	186,00
G 1 1/8"	11	37,897	511576	130,00				
G 1 1/4"	11	41,910			510764	76,00	510022	70,20
G 1 1/2"	11	47,803			510763	87,80	510019	81,10
G 1 3/4"	11	53,746			510767	106,00	510025	97,40
G 2"	11	59,614			510786	110,00	510035	101,00
G 2 1/4"	11	65,710			510789	133,00	510037	122,00
G 2 1/2"	11	75,184			510788	138,00	510036	128,00
G 2 3/4"	11	81,534			510790	163,00	510038	151,00
G 3"	11	87,884			510791	162,00	510039	150,00
G 3 1/2"	11	100,330			510792	196,00	510040	181,00
G 4"	11	113,030			510798	233,00	510044	216,00
G 4 1/2"	11	125,730			520129	295,00	520131	274,00
G 5"	11	138,430			516657	325,00	520132	302,00
G 5 1/2"	11	151,130			520130	352,00	520133	327,00
G 6"	11	163,830			516658	387,00	516573	360,00

Preise für Sondertoleranzen auf Anfrage

Prices for special tolerances on request



Präzisions-Gewindelehren Whitworth-Rohrgewinde DIN EN ISO 228

Lehrenmaße nach DIN EN ISO 228-2

Precision thread gauges

Whitworth pipe thread DIN EN ISO 228

Gauge dimensions acc. DIN EN ISO 228-2



ORDER-CODE →			LD-LH	GD-LH	AD-LH			
d	P Gg/1" tpi	Ø d mm	links Grenzlehrdorn left hand Plug gauge	links Gutlehrdorn left hand GO plug gauge	links Ausschusslehrdorn left hand NOT GO plug gauge			
↓								
			Art.-Nr.	€	Art.-Nr.	€	Art.-Nr.	€
G 1/16"	28	7,723						
G 1/8"	28	9,728	511592	72,20				
G 1/4"	19	13,157	511588	75,50				
G 3/8"	19	16,662	511600	86,70				
G 1/2"	14	20,955	511583	99,40				
G 5/8"	14	22,911	514699	108,00				
G 3/4"	14	26,441	511596	115,00				
G 7/8"	14	30,201	514044	144,00				
G 1"	11	33,249	511575	140,00				
G 1 1/8"	11	37,897	517310	174,00				
G 1 1/4"	11	41,910			510765	98,70	510023	91,30
G 1 1/2"	11	47,803			513942	116,00	510021	107,00
G 1 3/4"	11	53,746			517311	137,00	514700	127,00
G 2"	11	59,614			510787	145,00	516571	134,00
G 2 1/4"	11	65,710			517312	173,00	517318	159,00
G 2 1/2"	11	75,184			517313	182,00	517319	168,00
G 2 3/4"	11	81,534			517314	202,00	517320	187,00
G 3"	11	87,884			517315	213,00	517321	197,00
G 3 1/2"	11	100,330						
G 4"	11	113,030						
G 4 1/2"	11	125,730						
G 5"	11	138,430						
G 5 1/2"	11	151,130						
G 6"	11	163,830						

Preise für Sondertoleranzen auf Anfrage

Prices for special tolerances on request



Präzisions-Gewindelehren

Whitworth-Rohrgewinde DIN EN ISO 228

Lehrenmaße nach DIN EN ISO 228-2

Precision thread gauges

Whitworth pipe thread DIN EN ISO 228
Gauge dimensions acc. DIN EN ISO 228-2

G

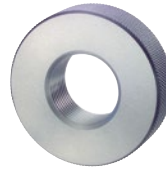
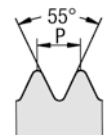

GR

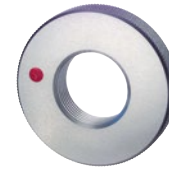

AR



ORDER-CODE →			GR	AR	GR-B	AR-B	GR-LH	AR-LH						
d	P Gg/1" tpi	Ø d mm	Tol. A Gutlehring tol. A GO ring gauge	Tol. A Ausschusslehring tol. A NOT GO ring gauge	Tol. B Gutlehring tol. B GO ring gauge	Tol. B Ausschusslehring tol. B NOT GO ring gauge	Tol. A links Gutlehring tol. A left hand GO ring gauge	Tol. A links Ausschusslehring tol. A left hand NOT GO ring gauge						
↓														
			Art.-Nr.	€	Art.-Nr.	€	Art.-Nr.	€	Art.-Nr.	€	Art.-Nr.	€		
G 1/16"	28	7,723	501361	87,00	500066	87,00								
G 1/8"	28	9,728	501376	45,90	500083	45,90	501377	66,80	500084	174,00	501380	61,60	500086	61,60
G 1/4"	19	13,157	501371	54,60	500077	54,60	501372	79,90	500078	203,00	501375	74,10	500082	74,10
G 3/8"	19	16,662	501399	64,80	500104	64,80	501400	94,60	500105	233,00	501404	85,10	500109	85,10
G 1/2"	14	20,955	501362	74,50	500067	74,50	501363	98,90	500068	210,00	501370	97,80	500076	97,80
G 5/8"	14	22,911	501408	90,00	500112	90,00					501412	117,00	500116	117,00
G 3/4"	14	26,441	501391	90,50	500098	90,50	501392	118,00	500099	226,00	501398	121,00	500103	121,00
G 7/8"	14	30,201	501414	117,00	500117	117,00					505910	152,00	505911	152,00
G 1"	11	33,249	501337	110,00	500043	110,00	501338	139,00	500044	250,00	501344	143,00	500050	143,00
G 1 1/8"	11	37,897	501358	132,00	500063	132,00					505562	175,00	506393	175,00
G 1 1/4"	11	41,910	501352	136,00	500056	136,00					503057	177,00	503056	177,00
G 1 1/2"	11	47,803	501346	152,00	500052	152,00	501347	189,00	503042	321,00	501351	198,00	505430	198,00
G 1 3/4"	11	53,746	501359	179,00	500064	179,00					506387	233,00	506394	233,00
G 2"	11	59,614	501381	187,00	500087	187,00					505564	244,00	505432	244,00
G 2 1/4"	11	65,710	501386	226,00	500092	226,00					506388	294,00	506395	294,00
G 2 1/2"	11	75,184	501385	254,00	500090	254,00					505565	330,00	505433	330,00
G 2 3/4"	11	81,534	501388	274,00	500094	274,00					506389	357,00	506396	357,00
G 3"	11	87,884	501389	296,00	500096	296,00					506390	385,00	506397	385,00
G 3 1/2"	11	100,330	501390	357,00	500097	357,00								
G 4"	11	113,030	501405	414,00	500110	414,00								
G 4 1/2"	11	125,730	541338	548,00	540586	548,00								
G 5"	11	138,430	501407	627,00	540587	627,00								
G 5 1/2"	11	151,130	505329	705,00	505330	705,00								
G 6"	11	163,830	501413	784,00	540590	784,00								

Preise für Sondertoleranzen auf Anfrage

Prices for special tolerances on request



Präzisions-Gewindelehren MultiCheck Withworth-Rohrgewinde DIN EN ISO 228

Lehrenmaße nach DIN EN ISO 228-2
Messtiefe bis 4 x D, max. 80 mm

Precision thread gauges MultiCheck

Whitworth pipe thread
DIN EN ISO 228
Gauge dimensions acc.
DIN EN ISO 228-2
Gauging up to depth 4 x D,
max. 80 mm

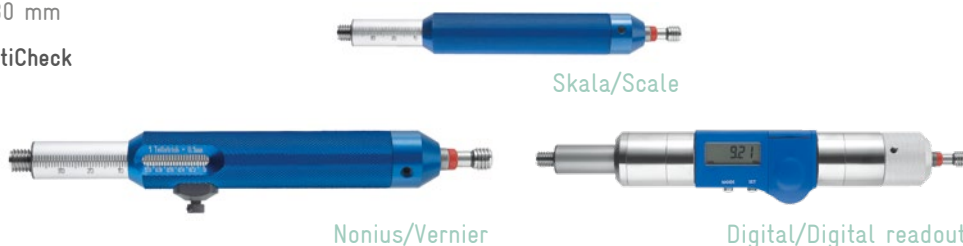

ORDER-CODE →				MCS		MCN		MCD		
Ablesegenauigkeit Accuracy of reading				0,5 mm		0,1 mm		0,01 mm		
d	P Gg/1" tpi	Ø d mm	System- größe System size	Skala Scale	Nonius Vernier	System- größe System size	Digital inkl. Prüfzert. Digital readout incl. inspection certificate			
↓										
				Art.-Nr.	€	Art.-Nr.	€	Art.-Nr.	€	
G 1/8"	28	9,728	20	590079	303,00	590262	418,00	28	590152	714,00
G 1/4"	19	13,157	25	590036	325,00	590263	450,00	35	590153	853,00
G 3/8"	19	16,662	28	590080	395,00	590264	534,00	35	590154	894,00
G 1/2"	14	20,955	36	590032	552,00	590265	703,00	35	590155	917,00

Preise für Gutseite DLC beschichtet auf Anfrage

MultiCheck Einstelllehre € 263,- (Art.-Nr. 592010)
Abb. siehe Seite 228

Abziehset für Gewinde
G1/8 - G1/2 € 132,-

Datenübertragung auf Anfrage

MultiCheck Digital mit integriertem Funk-Modul (MCDW)
auf Anfrage

Prices for G0 side DLC coated on request

MultiCheck setting gauge € 263,- (article no. 592010)
see figure page 228

dismantling kit for threads
G1/8 - G1/2 € 132,-

Data transfer on request

MultiCheck digital with integrated wireless data transmission
(MCDW) on request



Präzisions-Gewindelehren Whitworth-Gewinde BS 84

Lehrenmaße nach BS 919-2

Precision thread gauges

British Standard Whitworth thread BS 84
Gauge dimensions acc. BS 919-2

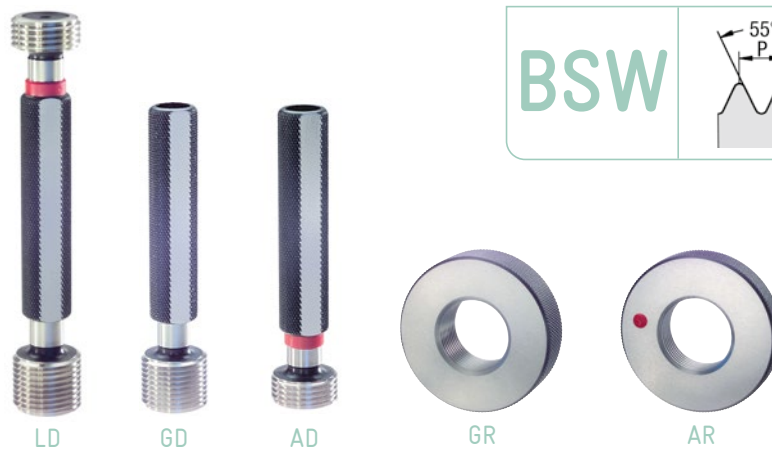

ORDER-CODE →			LD		GD		AD		GR		AR	
d	P Gg/1" tpi	Ø d mm	med. (medium class) Grenzlehndorn Plug gauge		med. (medium class) Gutlehdorn GO plug gauge		med. (medium class) Ausschusslehndorn NOT GO plug gauge		med. (medium class) Gutlehherring GO ring gauge		med. (medium class) Ausschusslehherring NOT GO ring gauge	
↓												
			Art.-Nr.	€	Art.-Nr.	€	Art.-Nr.	€	Art.-Nr.	€	Art.-Nr.	€
BSW 1/8"	40	3,175	512632	103,00					502615	89,30	501273	89,30
BSW 3/16"	24	4,763	512641	71,80					502626	66,00	501280	66,00
BSW 1/4"	20	6,350	512631	69,30					502614	63,50	501272	63,50
BSW 5/16"	18	7,938	512646	71,20					502631	68,50	501285	68,50
BSW 3/8"	16	9,525	512644	72,40					502629	71,80	501283	71,80
BSW 7/16"	14	11,113	512650	75,70					502635	75,70	501288	75,70
BSW 1/2"	12	12,700	512630	80,20					502613	80,20	501271	80,20
BSW 9/16"	12	14,288	512653	87,40					502640	90,10	501293	90,10
BSW 5/8"	11	15,875	512649	91,10					502633	96,30	501287	96,30
BSW 3/4"	10	19,050	512643	104,00					502628	106,00	501282	106,00
BSW 7/8"	9	22,225	512652	118,00					502638	122,00	501291	122,00
BSW 1"	8	25,400	512625	136,00					502606	137,00	501263	137,00
BSW 1 1/8"	7	28,575	513033	152,00					502608	152,00	501266	152,00
BSW 1 1/4"	7	31,750	512628	163,00					503134	167,00	501265	167,00
BSW 1 3/8"	6	34,925	516821	181,00					502611	184,00	501269	184,00
BSW 1 1/2"	6	38,100	512627	200,00					503133	200,00	501264	200,00
BSW 1 3/4"	5	44,450			513933	131,00	510680	119,00	502610	233,00	501268	233,00
BSW 2"	4 1/2	50,800			511410	154,00	510683	138,00	502619	268,00	501275	268,00



Präzisions-Gewindelehren Whitworth-Feingewinde BS 84

Lehrenmaße nach BS 919-2

Precision thread gauges

British Standard Whitworth fine thread BS 84

Gauge dimensions acc. BS 919-2



LD

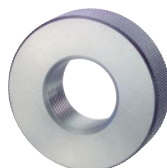

GR

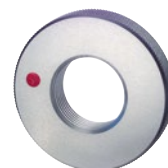

AR



ORDER-CODE →			LD	GR	AR			
d	P Gg/1" tpi	Ø d mm	med. (medium class) Grenzlehndorn Plug gauge	med. (medium class) Gutlehring GO ring gauge	med. (medium class) Ausschusslehring NOT GO ring gauge			
↓								
			Art.-Nr.	€	Art.-Nr.	€	Art.-Nr.	€
BSF 3/16"	32	4,763	513282	84,20	540040	78,20	520239	78,20
BSF 7/32"	28	5,556	520126	90,30	520234	84,20	520240	84,20
BSF 1/4"	26	6,350	512529	78,20	502498	72,30	501168	72,30
BSF 9/32"	26	7,144	520127	90,30	520235	84,20	520241	84,20
BSF 5/16"	22	7,938	513872	78,20	502501	75,90	501170	75,90
BSF 3/8"	20	9,525	513553	80,60	502500	82,10	501169	82,10
BSF 7/16"	18	11,113	518434	89,10	520236	89,10	520242	89,10
BSF 1/2"	16	12,700	512528	88,50	502497	91,00	501167	91,00
BSF 9/16"	16	14,288	514907	97,30	507251	101,00	507252	101,00
BSF 5/8"	14	15,875	520128	98,60	520237	104,00	520243	104,00
BSF 11/16"	14	17,463	513216	126,00	520238	125,00	520244	125,00
BSF 3/4"	12	19,050	512530	111,00	502499	117,00	505546	117,00
BSF 7/8"	11	22,225	516815	125,00	540035	131,00	540017	131,00
BSF 1"	10	25,400	512527	152,00	502496	150,00	501166	150,00

Präzisions-Gewindelehren

Kegeliges Whitworth-Rohrgewinde DIN 2999

Für im Gewinde dichtende Verbindungen
Lehrenmaße nach DIN 2999

Precision thread gauges

Tapered Whitworth pipe thread DIN 2999

Where pressure-tight joints are made on the threads

Gauge dimensions acc. DIN 2999



LD

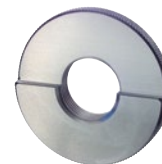

LR



ORDER-CODE →		LD-DIN 2999		LR-DIN 2999	
d	P Gg/1" tpi	Grenzlehndorn GO/NOT GO plug gauge		Grenzlehrring GO/NOT GO ring gauge	
↓					
		Art.-Nr.	€	Art.-Nr.	€
R 1/8"	28	512517	146,00	502689	104,00
R 1/4"	19	512516	155,00	502688	111,00
R 3/8"	19	512522	167,00	502694	134,00
R 1/2"	14	512515	182,00	502687	161,00
R 3/4"	14	512521	203,00	502693	184,00
R 1"	11	512512	239,00	502684	198,00
R 1 1/4"	11	512514	284,00	502686	235,00
R 1 1/2"	11	512513	320,00	502685	287,00
R 2"	11	512518	393,00	502690	320,00
R 2 1/2"	11	512519	462,00	502691	351,00
R 3"	11	512520	547,00	502692	407,00
R 4"	11	512523	773,00	502695	499,00

Grenzlehndorne sind mit GLD-Rp DIN 2999 beschriftet:
Zur Lehre von zylindrischen Innengewinden DIN 2999

Grenzlehrringe sind mit GLR-R DIN 2999 beschriftet:
Zur Lehre von kegeligen Außengewinden DIN 2999

Plug gauges are marked GLD-Rp DIN 2999:
They are used for gauging DIN 2999, internal parallel thread

Ring gauges are marked GLR-R DIN 2999:
They are used for gauging DIN 2999 external taper thread

Präzisions-Gewindelehren

Kegeliges Whitworth-Rohrgewinde ISO 7 und DIN EN 10226

Für im Gewinde dichtende Verbindungen
Lehrenmaße nach ISO 7-2:2000 und DIN EN 10226-3

Precision thread gauges

Tapered Whitworth pipe thread ISO 7 and DIN EN 10226
Where pressure-tight joints are made on the threads
Gauge dimensions acc. ISO 7-2:2000 and DIN EN 10226-3



LD

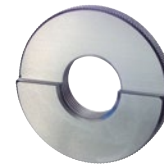

LR



ORDER-CODE →		LD-ISO 7-2:2000		LR-ISO 7-2:2000	
d	P Gg/1" tpi	Grenzlehndorn Nr. 1 GO/NOT GO plug gauge No. 1		Grenzlehrring Nr. 3 GO/NOT GO ring gauge No. 3	
		DIN EN 10226-3		DIN EN 10226-3	
↓					
		Art.-Nr.	€	Art.-Nr.	€
R 1/8"	28	514570	162,00	503880	117,00
R 1/4"	19	514571	172,00	503881	125,00
R 3/8"	19	514572	186,00	503882	150,00
R 1/2"	14	514573	201,00	503883	180,00
R 3/4"	14	514574	225,00	503884	206,00
R 1"	11	514575	264,00	503885	222,00
R 1 1/4"	11	514576	315,00	503886	263,00
R 1 1/2"	11	514577	355,00	503887	320,00
R 2"	11	514578	435,00	503888	359,00
R 2 1/2"	11	514579	512,00	503889	393,00
R 3"	11	517141	608,00	506024	452,00
R 4"	11	516167	858,00	546002	554,00

ISO 7-2:2000 identisch mit DIN EN 10226-3 sind Lehrensysteme, die weltweit genormt sind und die bisherigen Lehrensysteme DIN 2999, ISO 7-2:1982, BS 21, NFE 03-165 und UNI ISO 7-2:1984 ersetzen sollen.

ISO 7-2:2000 identical with DIN EN 10226-3 are international standard gauging systems and supersede the DIN 2999, ISO 7-2:1982, BS 21, NFE 03-165 and UNI ISO 7-2:1984 systems.

Grenzlehndorne ISO 7-2:2000 und DIN EN 10226-3 sind mit ISO 7 Rc/Rp Nr. 1 beschriftet:

Zur Lehren von zylindrischen Innengewinden Rp und kegeligen Innengewinden Rc nach ISO 7-1 oder DIN EN 10226

Grenzlehrringe ISO 7-2:2000 und DIN EN 10226-3 sind mit ISO 7 R Nr. 3 beschriftet:

Zur Lehren von kegeligen Außengewinden R nach ISO 7-1 oder DIN EN 10226

ISO 7-2:2000 and DIN EN 10226-3 plug gauges are marked ISO 7 Rc/Rp No. 1:

They are used for gauging ISO 7-1 or DIN EN 10226 Rp internal parallel and Rc internal taper thread

ISO 7-2:2000 and DIN EN 10226-3 ring gauges are marked ISO 7 R No. 3:

They are used for gauging R ISO 7-1 or DIN EN 10226 external taper thread

Präzisions-Gewindelehren Stahlpanzerrohr-Gewinde DIN 40430

Lehrenmaße nach DIN 40431

Precision thread gauges
Steel conduit thread DIN 40430
Gauge dimensions acc. DIN 40431



LD



GD



AD



GR

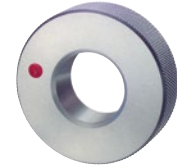

AR

Pg

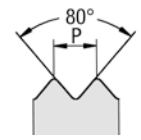

ORDER-CODE →			LD		GD		AD		GR		AR	
d	P Gg/1" tpi	Ø d mm	Grenzlehrdorn Plug gauge		Gutlehrdorn GO plug gauge		Ausschusslehrdorn NOT GO plug gauge		Gutlehrherring GO ring gauge		Ausschusslehrherring NOT GO ring gauge	
↓												
			Art.-Nr.	€	Art.-Nr.	€	Art.-Nr.	€	Art.-Nr.	€	Art.-Nr.	€
Pg 7	20	12,50	512492	59,90					502493	87,90	501164	38,90
Pg 9	18	15,20	512493	66,30					502494	96,00	501165	42,00
Pg 11	18	18,60	512484	75,00					502485	105,00	501156	45,40
Pg 13,5	18	20,40	512485	80,60					502486	113,00	501157	47,50
Pg 16	18	22,50	512486	86,00					502487	119,00	501158	49,30
Pg 21	16	28,30	512487	102,00					502488	145,00	501159	52,20
Pg 29	16	37,00	512488	135,00					502489	185,00	501160	54,20
Pg 36	16	47,00			511377	122,00	510640	67,50	502490	227,00	501161	62,10
Pg 42	16	54,00			513739	138,00	510641	77,00	502491	257,00	501162	76,80
Pg 48	16	59,30			511378	150,00	510642	83,70	502492	281,00	501163	81,70

Der Ausschusslehrdorn hat kein Gewinde und prüft nur den Mutterkern-Ø.

Der Ausschusslehrherring hat kein Gewinde und prüft nur den Bolzenaußen-Ø.

Das Stahlpanzerrohr-Gewinde DIN 40430 wird durch das Gewinde für Elektroinstallationsrohre DIN EN 60423 abgelöst.

The NOT GO plug gauge has no thread and checks only the minor diameter.

The NOT GO ring gauge has no thread and checks only the major diameter.

The steel conduit thread DIN 40430 will be superseded by electrical conduit thread DIN EN 60423.

Präzisions-Gewindelehren

Gewinde für Elektroinstallationsrohre DIN EN 60423

Lehrenmaße nach DIN EN 60423

Precision thread gauges
Electrical conduit thread DIN EN 60423
Gauge dimensions acc. DIN EN 60423

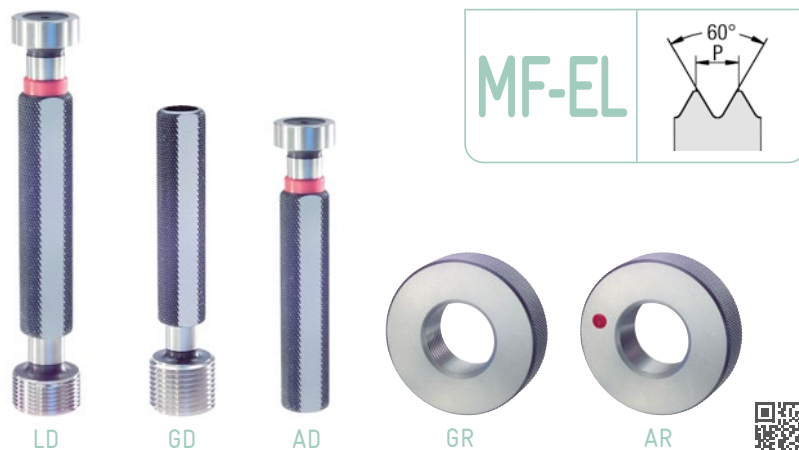

ORDER-CODE →		LD-DIN EN 60423	GD-DIN EN 60423	AD-DIN EN 60423	GR-DIN EN 60423	AR-DIN EN 60423	
d	P mm	7H Grenzlehndorn Plug gauge	7H Gutlehdorn GO plug gauge	7H Ausschusslehndorn glatt NOT GO plug gauge plain	8g Gutlehherring GO ring gauge	8g Ausschusslehherring glatt NOT GO ring gauge plain	
↓							
		Art.-Nr. €	Art.-Nr. €	Art.-Nr. €	Art.-Nr. €	Art.-Nr. €	
M 8	1	517137 88,00			507460 72,90	506013 49,60	
M 10	1	517138 94,20			507461 78,20	506014 53,30	
M 12	1,5	514557 102,00			507462 83,40	506015 57,00	
M 16	1,5	514558 109,00			507463 94,00	506016 60,80	
M 20	1,5	514559 119,00			504884 110,00	506017 68,00	
M 25	1,5	514560 143,00			504885 123,00	503871 72,70	
M 32	1,5	514561 169,00			504886 148,00	503872 82,30	
M 40	1,5	517139 202,00			507464 180,00	506018 103,00	
M 50	1,5		520134 160,00	517140 102,00	507465 219,00	506019 123,00	
M 63	1,5		520135 229,00	514562 128,00	507466 272,00	506020 157,00	
M 75	1,5		520136 240,00	514563 148,00	507467 327,00	506021 191,00	

Der Ausschusslehndorn hat kein Gewinde und prüft nur den Mutterkern-Ø.

Der Ausschusslehherring hat kein Gewinde und prüft nur den Bolzenaußen-Ø.

Das Gewinde für Elektroinstallationsrohre DIN EN 60423 soll das Stahlpanzerrohr-Gewinde DIN 40430 ablösen.

The NOT GO plug gauge has no thread and checks only the minor diameter.

The NOT GO ring gauge has no thread and checks only the major diameter.

The electrical conduit thread DIN EN 60423 supersedes the steel conduit thread DIN 40430.



Präzisions-Gewindelehren

UNC-Grobgewinde ASME B1.1

Lehrenmaße nach ANSI / ASME B1.2

Precision thread gauges

Unified national coarse thread ASME B1.1
Gauge dimensions acc. ANSI / ASME B1.2



LD

GD

AD

UNC

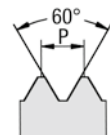

ORDER-CODE →			LD	GD	AD	LD-3B	LD-LH			
d	P Gg/1" tpi	Ø d mm	2B Grenzlehrdorn Plug gauge	2B Gutlehrdorn GO plug gauge	2B Ausschusslehrdorn NOT GO plug gauge	3B Grenzlehrdorn Plug gauge	2B links Grenzlehrdorn left hand Plug gauge			
↓										
			Art.-Nr.	€	Art.-Nr.	€	Art.-Nr.	€	Art.-Nr.	€
UNC Nr. 1	64	1,854	512363	100,00			512364	130,00	517324	144,00
UNC Nr. 2	56	2,184	512368	75,70			512369	98,20	517325	109,00
UNC Nr. 3	48	2,515	512373	75,70			512374	98,20	517326	109,00
UNC Nr. 4	40	2,845	512375	64,40			512377	83,50	514701	92,90
UNC Nr. 5	40	3,175	512382	64,40			512383	83,50	517327	92,90
UNC Nr. 6	32	3,505	512384	53,90			512386	69,80	514702	77,60
UNC Nr. 8	32	4,166	512389	51,10			512390	66,20	514703	73,70
UNC Nr. 10	24	4,826	512365	50,10			512366	65,00	514070	72,30
UNC Nr. 12	24	5,486	512367	54,20			516808	70,30	517328	78,10
UNC 1/4"	20	6,350	512403	48,90			512404	64,20	512405	71,20
UNC 5/16"	18	7,938	512410	48,90			512412	64,20	517329	71,20
UNC 3/8"	16	9,525	512408	50,40			513092	66,00	512409	73,30
UNC 7/16"	14	11,113	512415	54,60			512416	71,00	517330	78,90
UNC 1/2"	13	12,700	512401	56,10			512402	73,40	516810	81,60
UNC 9/16"	12	14,288	512419	60,80			512420	78,90	517331	87,70
UNC 5/8"	11	15,875	512413	62,60			512414	82,10	517332	91,30
UNC 3/4"	10	19,050	512406	71,40			512407	93,40	514704	104,00
UNC 7/8"	9	22,225	512417	83,00			512418	108,00	517333	120,00
UNC 1"	8	25,400	512392	93,80			512393	122,00	514705	135,00
UNC 1 1/8"	7	28,575	512398	106,00					517334	153,00
UNC 1 1/4"	7	31,750	512396	114,00					517335	164,00
UNC 1 3/8"	6	34,925	512399	133,00					517336	192,00
UNC 1 1/2"	6	38,100	512394	148,00					517337	213,00
UNC 1 3/4"	5	44,450			511328	110,00	510588	99,30		
UNC 2"	4 1/2	50,800			511333	126,00	510591	113,00		
UNC 2 1/4"	4 1/2	57,150			513180	136,00	513179	123,00		
UNC 2 1/2"	4	63,500			520137	153,00	513618	138,00		
UNC 2 3/4"	4	69,850			514464	169,00	514465	153,00		



Präzisions-Gewindelehren

UNC-Grobgewinde ASME B1.1

Lehrenmaße nach ANSI / ASME B1.2

Precision thread gauges

Unified national coarse thread ASME B1.1
Gauge dimensions acc. ANSI / ASME B1.2

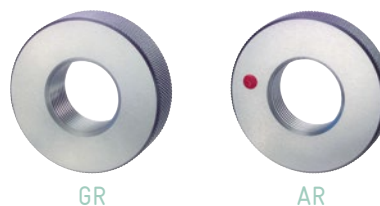

ORDER-CODE →			GR	AR	GR-3A	AR-3A	GR-LH	AR-LH						
d	P Gg/1" tpi	Ø d mm	2A Gutlehring GO ring gauge	2A Ausschusslehring NOT GO ring gauge	3A Gutlehring GO ring gauge	3A Ausschusslehring NOT GO ring gauge	2A links Gutlehring left hand GO ring gauge	2A links Ausschusslehring left hand NOT GO ring gauge						
↓														
			Art.-Nr.	€	Art.-Nr.	€	Art.-Nr.	€	Art.-Nr.	€	Art.-Nr.	€		
UNC Nr. 1	64	1,854	502377	89,00	501051	89,00	502378	130,00	501052	130,00	506400	127,00	506412	127,00
UNC Nr. 2	56	2,184	502382	67,00	501057	67,00	502385	100,00	501060	100,00	506401	101,00	506413	101,00
UNC Nr. 3	48	2,515	502386	80,60	501061	80,60	502387	107,00	501062	107,00	506402	115,00	506414	115,00
UNC Nr. 4	40	2,845	502388	58,80	501063	58,80	502391	82,30	501065	82,30	504041	88,20	504045	88,20
UNC Nr. 5	40	3,175	502392	53,80	501066	53,80	502873	75,30	502874	75,30	506403	80,60	506415	80,60
UNC Nr. 6	32	3,505	502393	45,90	501067	45,90	502394	64,20	501068	64,20	502395	68,80	501069	68,80
UNC Nr. 8	32	4,166	502396	43,20	501070	43,20	502397	60,40	501071	60,40	506404	64,80	506416	64,80
UNC Nr. 10	24	4,826	502379	42,30	501053	42,30	502380	60,60	501054	60,60	503427	63,40	503428	63,40
UNC Nr. 12	24	5,486	505676	49,30	501055	49,30	502381	64,00	501056	64,00	505677	68,50	505540	68,50
UNC 1/4"	20	6,350	502406	40,50	501080	40,50	502407	59,30	501081	59,30	502408	60,70	501082	60,70
UNC 5/16"	18	7,938	502416	43,00	501088	43,00	502417	63,10	501089	63,10	502418	64,50	501090	64,50
UNC 3/8"	16	9,525	502413	46,90	501085	46,90	502414	68,70	501086	68,70	502415	70,40	501087	70,40
UNC 7/16"	14	11,113	502421	51,00	501093	51,00	502422	76,50	501094	76,50	506405	76,50	506417	76,50
UNC 1/2"	13	12,700	502404	56,10	501078	56,10	502405	84,10	501079	84,10	506406	84,10	506418	84,10
UNC 9/16"	12	14,288	502425	77,40	501097	77,40	503165	93,90	503178	93,90	506407	92,50	506420	92,50
UNC 5/8"	11	15,875	502419	65,90	501091	65,90	502420	100,00	501092	100,00	504042	102,00	504046	102,00
UNC 3/4"	10	19,050	502411	81,40	501083	81,40	502797	122,00	502798	122,00	502412	122,00	501084	122,00
UNC 7/8"	9	22,225	502423	99,50	501095	99,50	502424	149,00	501096	149,00	506408	149,00	506422	149,00
UNC 1"	8	25,400	502398	108,00	501072	108,00	503166	163,00	503179	163,00	504043	163,00	506423	163,00
UNC 1 1/8"	7	28,575	502401	144,00	501075	144,00					506409	192,00	506424	192,00
UNC 1 1/4"	7	31,750	502400	154,00	501074	154,00					505756	209,00	506426	209,00
UNC 1 3/8"	6	34,925	502403	167,00	501077	167,00					506410	233,00	506428	233,00
UNC 1 1/2"	6	38,100	502399	182,00	501073	182,00					506411	249,00	506430	249,00
UNC 1 3/4"	5	44,450	502402	229,00	501076	229,00								
UNC 2"	4 1/2	50,800	502409	261,00	503352	261,00								
UNC 2 1/4"	4 1/2	57,150	502963	298,00	502964	298,00								
UNC 2 1/2"	4	63,500	502410	333,00	541018	333,00								
UNC 2 3/4"	4	69,850	507588	371,00	507589	371,00								



Präzisions-Gewindelehren

UNF-Feingewinde ASME B1.1

Lehrenmaße nach ANSI / ASME B1.2

Precision thread gauges

Unified national fine thread ASME B1.1

Gauge dimensions acc. ANSI / ASME B1.2



LD



ORDER-CODE →			LD		LD-3B		LD-LH	
d	P Gg/1" tpi	Ø d mm	2B Grenzlehrdorn Plug gauge		3B Grenzlehrdorn Plug gauge		2B links Grenzlehrdorn left hand Plug gauge	
↓								
			Art.-Nr.	€	Art.-Nr.	€	Art.-Nr.	€
UNF Nr. 0	80	1,524	512421	95,00	512422	123,00	517341	133,00
UNF Nr. 1	72	1,854	512424	83,30	512425	108,00	517342	116,00
UNF Nr. 2	64	2,184	512432	93,00	512433	121,00	517343	130,00
UNF Nr. 3	56	2,515	512434	87,10	512435	113,00	517344	122,00
UNF Nr. 4	48	2,845	512436	75,90	512437	98,60	517345	106,00
UNF Nr. 5	44	3,175	512438	67,60	512439	87,70	517346	94,60
UNF Nr. 6	40	3,505	512440	56,90	512441	73,90	517347	82,10
UNF Nr. 8	36	4,166	512442	53,80	512443	69,70	517348	77,40
UNF Nr. 10	32	4,826	512426	49,60	512428	64,40	512430	71,50
UNF Nr. 12	28	5,486	512431	54,20	516811	70,30	517349	78,10
UNF 1/4"	28	6,350	512456	48,90	512458	64,20	512459	71,20
UNF 5/16"	24	7,938	512466	48,90	512467	64,20	512468	71,20
UNF 3/8"	24	9,525	512462	50,50	512463	66,10	512464	73,60
UNF 7/16"	20	11,113	512472	52,50	512473	68,80	514344	76,50
UNF 1/2"	20	12,700	512454	56,10	512455	73,60	516996	81,60
UNF 9/16"	18	14,288	512478	59,10	512479	76,60	512480	85,20
UNF 5/8"	18	15,875	512469	62,60	512470	82,10	512471	91,20
UNF 3/4"	16	19,050	512460	70,20	512461	92,00	516813	102,00
UNF 7/8"	14	22,225	512476	79,00	512477	102,00	513423	114,00
UNF 1"	12	25,400	512444	86,70	512445	112,00	513491	125,00
UNF 1 1/8"	12	28,575	512451	98,90	512452	128,00	514147	143,00
UNF 1 1/4"	12	31,750	512449	105,00	512450	137,00	517350	152,00
UNF 1 3/8"	12	34,925	512453	118,00	513533	154,00	514709	171,00
UNF 1 1/2"	12	38,100	512446	130,00	512448	169,00	517351	188,00

Präzisions-Gewindelehren

UNF-Feingewinde ASME B1.1

Lehrenmaße nach ANSI / ASME B1.2

Precision thread gauges

Unified national fine thread ASME B1.1

Gauge dimensions acc. ANSI / ASME B1.2

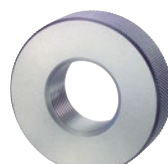

GR

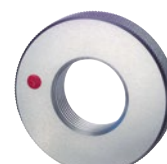

AR



ORDER-CODE →			GR		AR		GR-3A		AR-3A		GR-LH		AR-LH	
d	P Gg/1" tpi	Ø d mm	2A Gutlehring GO ring gauge		2A Ausschusslehring NOT GO ring gauge		3A Gutlehring GO ring gauge		3A Ausschusslehring NOT GO ring gauge		2A links Gutlehring left hand GO ring gauge		2A links Ausschusslehring left hand NOT GO ring gauge	
↓														
			Art.-Nr.	€	Art.-Nr.	€	Art.-Nr.	€	Art.-Nr.	€	Art.-Nr.	€	Art.-Nr.	€
UNF Nr. 0	80	1,524	502426	98,30	501099	98,30	502427	138,00	501100	138,00	506438	138,00	506458	138,00
UNF Nr. 1	72	1,854	502428	82,20	501101	82,20	502429	115,00	501102	115,00	506441	115,00	506460	115,00
UNF Nr. 2	64	2,184	502436	82,10	501108	82,10	502437	108,00	501109	108,00	506445	108,00	506461	108,00
UNF Nr. 3	56	2,515	502438	81,80	501110	81,80	502439	107,00	501111	107,00	506448	107,00	506462	107,00
UNF Nr. 4	48	2,845	502440	72,40	501112	72,40	502441	95,10	501113	95,10	506449	95,10	506463	95,10
UNF Nr. 5	44	3,175	502442	58,10	501114	58,10	502443	75,30	501115	75,30	506452	75,30	506465	75,30
UNF Nr. 6	40	3,505	502444	55,90	501116	55,90	502445	72,50	501117	72,50	506453	72,50	506466	72,50
UNF Nr. 8	36	4,166	502446	51,70	501118	51,70	502447	66,70	501119	66,70	506454	66,70	506468	66,70
UNF Nr. 10	32	4,826	502430	41,00	501103	41,00	502431	57,30	501104	57,30	502432	59,50	501105	59,50
UNF Nr. 12	28	5,486	502433	49,30	501106	49,30	502435	64,00	501107	64,00	506455	65,20	506470	65,20
UNF 1/4"	28	6,350	502458	40,60	501130	40,60	502459	56,80	501131	56,80	502460	56,80	501132	56,80
UNF 5/16"	24	7,938	502469	43,00	501140	43,00	502470	60,10	501141	60,10	502471	63,10	501142	63,10
UNF 3/8"	24	9,525	502466	46,90	501137	46,90	502467	65,70	501138	65,70	502468	65,70	501139	65,70
UNF 7/16"	20	11,113	502475	50,50	501146	50,50	502476	70,60	501147	70,60	502477	72,40	501148	72,40
UNF 1/2"	20	12,700	502455	56,10	501127	56,10	502456	78,40	501128	78,40	502457	81,60	501129	81,60
UNF 9/16"	18	14,288	502481	60,40	501152	60,40	502482	84,50	501153	84,50	502483	90,80	501154	90,80
UNF 5/8"	18	15,875	502472	66,70	501143	66,70	502473	93,20	501144	93,20	502474	93,20	501145	93,20
UNF 3/4"	16	19,050	502461	77,60	501133	77,60	502463	109,00	501134	109,00	502464	109,00	501135	109,00
UNF 7/8"	14	22,225	502478	91,20	501149	91,20	502479	128,00	501150	128,00	502480	128,00	501151	128,00
UNF 1"	12	25,400	502448	103,00	501120	103,00	502449	144,00	501121	144,00	502450	144,00	501122	144,00
UNF 1 1/8"	12	28,575	502453	115,00	501125	115,00	502757	161,00	502758	161,00	503127	161,00	503126	161,00
UNF 1 1/4"	12	31,750	502452	125,00	501124	125,00	503207	176,00	503208	176,00	506456	176,00	506473	176,00
UNF 1 3/8"	12	34,925	502454	137,00	501126	137,00	503209	192,00	503210	192,00	506457	192,00	506476	192,00
UNF 1 1/2"	12	38,100	502451	146,00	501123	146,00	502768	205,00	502767	205,00	505736	205,00	502851	205,00



Präzisions-Gewindelehren

UNEF-Extra Feingwinde ASME B1.1

Lehrenmaße nach ANSI / ASME B1.2

Precision thread gauges

Unified national extra fine thread ASME B1.1
Gauge dimensions acc. ANSI / ASME B1.2



LD

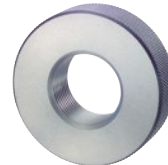

GR

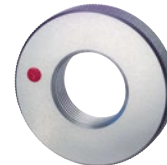

AR



ORDER-CODE →			LD		LD-LH		GR		AR		GR-LH		AR-LH	
d	P Gg/1" tpi	Ø d mm	2B Grenzlehndorn Plug gauge		2B links Grenzlehndorn left hand Plug gauge		2A Gutlehring GO ring gauge		2A Ausschuslehring NOT GO ring gauge		2A links Gutlehring left hand GO ring gauge		2A links Ausschuslehring left hand NOT GO ring gauge	
			Art.-Nr.	€	Art.-Nr.	€	Art.-Nr.	€	Art.-Nr.	€	Art.-Nr.	€	Art.-Nr.	€
UNEF Nr. 12	32	5,486	511537	63,40	517352	84,20	501299	58,30	500006	58,30	506489	82,50	506504	82,50
UNEF 1/4"	32	6,350	511550	63,40	516900	84,20	501313	58,30	500019	58,30	501315	82,50	500021	82,50
UNEF 5/16"	32	7,938	511560	66,00	517353	87,40	501326	62,40	500033	62,40	506490	90,50	506505	90,50
UNEF 3/8"	32	9,525	511558	67,40	517354	89,30	501323	66,50	500029	66,50	506491	94,40	506506	94,40
UNEF 7/16"	28	11,113	511565	69,80	514710	92,40	501329	70,60	500036	70,60	501332	99,50	500038	99,50
UNEF 1/2"	28	12,700	511548	71,10	517355	94,20	501310	73,70	500016	73,70	503778	105,00	503779	105,00
UNEF 9/16"	24	14,288	511569	74,20	517356	98,30	501334	81,50	500040	81,50	505871	114,00	505872	114,00
UNEF 5/8"	24	15,875	511562	76,70	517357	102,00	501327	87,10	500034	87,10	503138	130,00	503137	130,00
UNEF 11/16"	24	17,463	511552	79,90	517358	106,00	501316	93,80	500022	93,80	506492	140,00	506507	140,00
UNEF 3/4"	20	19,050	511556	82,30	514711	109,00	501319	98,80	500025	98,80	501322	148,00	500028	148,00
UNEF 13/16"	20	20,638	511554	86,10	517359	114,00	501317	105,00	500023	105,00	506493	158,00	506508	158,00
UNEF 7/8"	20	22,225	511568	90,50	517360	120,00	501333	113,00	500039	113,00	506494	170,00	506509	170,00
UNEF 15/16"	20	23,813	511555	94,10	517361	125,00	501318	121,00	500024	121,00	506495	182,00	506510	182,00
UNEF 1"	20	25,400	511539	96,80	517362	128,00	501300	127,00	500007	127,00	504056	191,00	504057	191,00
UNEF 1 1/16"	18	26,988	511543	103,00			501305	135,00	500011	135,00				
UNEF 1 1/8"	18	28,575	511542	108,00			501303	141,00	505428	141,00				
UNEF 1 3/16"	18	30,163	511545	114,00			501307	149,00	500013	149,00				
UNEF 1 1/4"	18	31,750	511541	119,00			501302	158,00	500009	158,00				
UNEF 1 5/16"	18	33,338	511546	126,00			501308	167,00	500014	167,00				
UNEF 1 3/8"	18	34,925	511544	132,00			501306	176,00	500012	176,00				
UNEF 1 7/16"	18	36,513	511547	139,00			501309	185,00	500015	185,00				
UNEF 1 1/2"	18	38,100	511540	147,00			501301	194,00	500008	194,00				
UNEF 1 9/16"	18	39,688	514880	159,00			506769	207,00	503813	207,00				

Präzisions-Gewindelehren

UN-Gewinde, UNS-Spezialgewinde ASME B1.1

Lehrenmaße nach ANSI / ASME B1.2

Precision thread gauges

Unified national thread, Unified national special thread ASME B 1.1 selection
Gauge dimensions acc. ANSI /ASME B1.2



ORDER-CODE →			LD	GD	AD	GR	AR					
d	P Gg/1" tpi	Ø d mm	2B Grenzlehndorn Plug gauge	2B Gutlehdorn GO plug gauge	2B Ausschusslehndorn NOT GO plug gauge	2A Gutlehdorn GO ring gauge	2A Ausschusslehdorn NOT GO ring gauge					
↓	↓											
			Art.-Nr.	€	Art.-Nr.	€	Art.-Nr.	€	Art.-Nr.	€		
UNS 1/4"	36	6,350	512599	161,00			502570	161,00	501232	161,00		
UN 1"	32	25,400	512583	281,00			502546	329,00	501205	329,00		
UN 11/16"	16	17,463	512603	231,00			502576	274,00	501237	274,00		
UN 13/16"	16	20,638	512604	238,00			502580	239,00	501240	239,00		
UN 7/8"	16	22,225	512618	258,00			502601	245,00	501259	245,00		
UN 1"	16	25,400	513082	263,00			502545	274,00	501204	274,00		
UN 1 1/16"	16	26,988	514092	266,00			542688	289,00	540054	289,00		
UN 1 3/16"	16	30,163	512593	272,00			502561	318,00	501223	318,00		
UNS 1"	14	25,400	512580	248,00			505372	225,00	501202	225,00		
UN 1 1/16"	12	26,988	512588	229,00			502552	250,00	501214	250,00		
UN 1 3/16"	12	30,163	512592	242,00			502560	284,00	501222	284,00		
UN 1 5/16"	12	33,338	512594	275,00			502563	280,00	501225	280,00		
UN 1 5/8"	12	41,275			511394	222,00	510663	204,00	502562	358,00	502756	358,00
UN 1 3/4"	12	44,450			513514	222,00	513513	204,00	502554	344,00	501216	344,00
UN 1 7/8"	12	47,625			511396	245,00	510666	225,00	502565	376,00	501227	376,00
UN 2"	12	50,800			513044	276,00	513045	235,00	502584	382,00	502835	382,00
UN 1 1/8"	8	28,575	512586	292,00					503417	279,00	501213	279,00
UN 1 1/4"	8	31,750	512585	333,00					502549	280,00	501209	280,00
UN 1 3/8"	8	34,925	512591	359,00					552099	302,00	501221	302,00
UN 1 1/2"	8	38,100	512584	361,00					502547	362,00	501207	362,00
UN 1 5/8"	8	41,275			514511	264,00	514512	218,00	502924	380,00	501224	380,00
UN 1 3/4"	8	44,450			511392	259,00	510661	238,00	502556	431,00	501218	431,00
UN 2"	8	50,800			511399	292,00	510670	271,00	503356	465,00	503355	465,00



Präzisions-Gewindelehren

UNJC-Grobgewinde ISO 3161, ASME B1.15

Lehrenmaße nach ANSI / ASME B1.2

Precision thread gauges

UNJC Unified national coarse thread ISO 3161, ASME B1.15

Gauge dimensions acc. ANSI / ASME B1.2

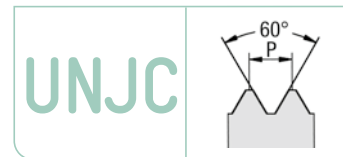

LD

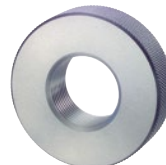

GR

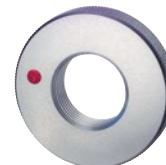

AR



ORDER-CODE →			LD		GR		AR	
d	P Gg/1" tpi	Ø d mm	3B Grenzlehrdorn Plug gauge		3A Gutlehring GO ring gauge		3A Ausschusslehring NOT GO ring gauge	
↓								
			Art.-Nr.	€	Art.-Nr.	€	Art.-Nr.	€
UNJC Nr. 2	56	2,184	514228	114,00	504210	130,00	504211	130,00
UNJC Nr. 4	40	2,845	511603	98,00	503593	109,00	503594	109,00
UNJC Nr. 6	32	3,505	511604	89,30	505569	94,20	500119	94,20
UNJC Nr. 8	32	4,166	511605	84,30	501415	86,80	500120	86,80
UNJC Nr. 10	24	4,826	514625	86,80	547026	86,80	544018	86,80
UNJC 1/4"	20	6,350	518292	86,80	547027	86,80	544019	86,80
UNJC 5/16"	18	7,938	516556	84,30	547028	86,80	544020	86,80
UNJC 3/8"	16	9,525	515276	85,50	507449	90,50	544021	90,50
UNJC 7/16"	14	11,113	515969	106,00	554996	115,00	554997	115,00

Präzisions-Gewindelehren

UNJF-Feingewinde ISO 3161, ASME B1.15

Lehrenmaße nach ANSI / ASME B1.2

Precision thread gauges

UNJF Unified national fine thread ISO 3161 / ASME B1.15

Gauge dimensions acc. ANSI / ASME B1.2



LD

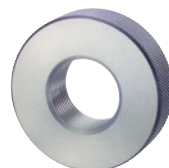

GR

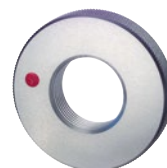

AR



ORDER-CODE			LD		GR		AR		LD-LH		GR-LH		AR-LH	
d	P Gg/1" tpi	Ø d mm	3B Grenzlehndorn Plug gauge		3A Gutlehring GO ring gauge		3A Ausschusslehring NOT GO ring gauge		3B links Grenzlehndorn left hand Plug gauge		2A links Gutlehring left hand GO ring gauge		2A links Ausschusslehring left hand NOT GO ring gauge	
↓														
			Art.-Nr.	€	Art.-Nr.	€	Art.-Nr.	€	Art.-Nr.	€	Art.-Nr.	€	Art.-Nr.	€
UNJF Nr. 4	48	2,845	514760	104,00	547029	112,00	544022	112,00						
UNJF Nr. 6	40	3,505	518725	93,00	505347	91,50	505348	91,50						
UNJF Nr. 8	36	4,166	514327	88,00	501418	84,20	500123	84,20						
UNJF Nr. 10	32	4,826	511606	81,80	501417	73,50	500122	73,50						
UNJF Nr. 12	28	5,486	517771	86,80	504244	84,20	504245	84,20						
UNJF 1/4"	28	6,350	511609	81,80	501419	73,50	500125	73,50	516765	127,00	547575	118,00	544318	118,00
UNJF 5/16"	24	7,938	511612	81,80	501422	77,00	500127	77,00	511613	127,00	504250	123,00	504653	123,00
UNJF 3/8"	24	9,525	511611	84,30	501421	83,00	500126	83,00	520938	131,00	503866	133,00	503867	133,00
UNJF 7/16"	20	11,113	511615	88,00	501424	90,30	500129	90,30						
UNJF 1/2"	20	12,700	511608	93,00	502986	99,90	502985	99,90	513270	144,00	547590	160,00	544329	160,00
UNJF 9/16"	18	14,288	511617	98,00	501425	107,00	500130	107,00						
UNJF 5/8"	18	15,875	511614	105,00	501423	119,00	500128	119,00						
UNJF 3/4"	16	19,050	511610	116,00	501420	138,00	503100	138,00	514326	181,00	503728	194,00	503729	194,00
UNJF 7/8"	14	22,225	511616	129,00	503651	161,00	503652	161,00						
UNJF 1"	12	25,400	511607	141,00	503703	182,00	500124	182,00						

- M
MF
MJ
EG M
- G
Rc, R
Pg
- UNC
UNF
UN
UNJF
- NPT
NPTF
- M
MF
M keg.
M taper
- G
BSW
BSF
DIN 477
R, BA, Pg
- UNC
UNF
UNEF
UN, UNS
- NPSM
NPT
NPTF
Tr, Rd
- M
MF
- G
BSW
BSF
R, Pg
MF-EL
- UNC, UNF
UNEF
UN, UNS
UNJC
UNJF
- NPT
NPTF
Tr
EG

Präzisions-Gewindelehren

NPT-Kegeliges Amerikanisches Rohrgewinde ASME B1.20.1

Kegel 1:16
Für Gewinde mit Dichtmittel
Lehrenmaße nach ASME B1.20.1*

Precision thread gauges
American Standard taper pipe thread ASME B1.20.1
Taper 1:16
For threads used with jointing compound
Gauge dimensions acc. ASME B1.20.1*



LD

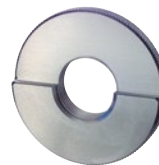

LR



ORDER-CODE →	P Gg/1" tpi	LD		LR	
		Grenzlehrdorn (L1) GO/NOT GO plug gauge		Grenzlehring (L1) GO/NOT GO ring gauge	
d					
		Art.-Nr.	€	Art.-Nr.	€
NPT 1/16"	27	512502	131,00	502671	224,00
NPT 1/8"	27	512505	123,00	502675	207,00
NPT 1/4"	18	512504	131,00	502673	212,00
NPT 3/8"	18	512510	141,00	502681	223,00
NPT 1/2"	14	512503	154,00	502672	242,00
NPT 3/4"	14	512509	174,00	502680	264,00
NPT 1"	11,5	512499	200,00	502668	299,00
NPT 1 1/4"	11,5	512501	262,00	502670	351,00
NPT 1 1/2"	11,5	512500	296,00	502669	387,00
NPT 2"	11,5	512506	364,00	502677	473,00
NPT 2 1/2"	8	512507	431,00	502678	541,00
NPT 3"	8	512508	523,00	502679	692,00
NPT 3 1/2"	8	522600	684,00	542056	944,00
NPT 4"	8	512511	777,00	502683	1138,00

*Ausführung mit Gut- und Ausschusstufe
Gewindelehren für erweiterte Prüfungen auf Anfrage

*2-step design with GO and NOT GO step
Additional thread gauges for comprehensive gauging on request



Präzisions-Gewindelehren

NPTF-Kegeliges Amerikanisches Rohrgewinde ANSI B1.20.3

Kegel 1:16
Für Gewinde ohne Dichtmittel
Lehrenmaße nach ASA B2.2

Precision thread gauges
American Standard taper pipe thread ANSI B1.20.3
Taper 1:16
For threads used without jointing compound
Gauge dimensions acc. ASA B2.2

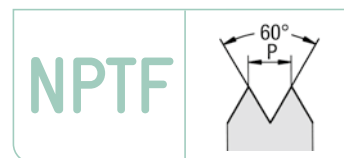

LD

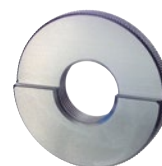

LR



ORDER-CODE →		LD	LR
d	P Gg/1" tpi	Grenzlehndorn (L1) GO/NOT GO plug gauge	Grenzlehrring (L1) GO/NOT GO ring gauge
↓			
		Art.-Nr. €	Art.-Nr. €
NPTF 1/16"	27	512542 144,00	505811 247,00
NPTF 1/8"	27	512545 149,00	502700 227,00
NPTF 1/4"	18	512544 158,00	502699 234,00
NPTF 3/8"	18	512547 170,00	502702 245,00
NPTF 1/2"	14	512543 185,00	502698 265,00
NPTF 3/4"	14	512546 206,00	502701 292,00
NPTF 1"	11,5	512539 238,00	502697 330,00
NPTF 1 1/4"	11,5	512541 288,00	503479 387,00
NPTF 1 1/2"	11,5	512540 326,00	503480 426,00
NPTF 2"	11,5	513622 400,00	505713 520,00
NPTF 2 1/2"	8	517008 474,00	505885 595,00
NPTF 3"	8	517007 576,00	505886 761,00

Standardlehren sind nach Ausführung L1 gefertigt,
mit Gut- und Ausschusstufe

Lehrdorne L3 und Lehrringe L2 auf Anfrage

Standard gauges are of type L1 with GO and NOT GO step

Plug gauges L3 and ring gauges L2 on request

Präzisions-Gewindelehren

Metrisches ISO-Trapez-Gewinde DIN 103

Lehrenmaße nach DIN 103-9

Precision thread gauges

ISO metric trapezoidal thread DIN 103

Gauge dimensions acc. DIN 103-9



LD



GR



AR



ORDER-CODE →		LD		GR		AR	
d	P mm	7H Grenzlehndorn Plug gauge		7e Gutlehring GO ring gauge		7e Ausschuslehring NOT GO ring gauge	
↓	↓						
		Art.-Nr.	€	Art.-Nr.	€	Art.-Nr.	€
Tr 8	1,5	515056	151,00	502538	213,00	501198	213,00
Tr 10	2	512549	157,00	502508	218,00	501177	218,00
Tr 11	2	514745	157,00	502510	222,00	501179	222,00
Tr 12	3	512554	158,00	502512	224,00	503037	224,00
Tr 14	3	512557	161,00	502515	227,00	503435	227,00
Tr 16	4	512559	166,00	502517	235,00	501185	235,00
Tr 18	4	512561	172,00	503375	238,00	501187	238,00
Tr 20	4	512563	176,00	502521	248,00	501188	248,00
Tr 22	5	512565	186,00	502523	259,00	501189	259,00
Tr 24	5	512566	196,00	502525	273,00	501191	273,00
Tr 26	5	512569	205,00	502527	283,00	501193	283,00
Tr 28	5	512570	214,00	503465	296,00	503466	296,00
Tr 30	6	512571	226,00	502531	308,00	502742	308,00
Tr 32	6	512572	230,00	502825	317,00	502826	317,00



Präzisions-Gewindelehren
 Einsatzgewinde (EG) für
 Gewindedrahteinsätze
 EG Metrisches ISO-Gewinde DIN 8140-2
 Lehrenmaße nach DIN ISO 1502
 EG UNC-Gewinde nach Werksnorm
 EG UNF-Gewinde nach Werksnorm

Precision thread gauges
 Threads for wire inserts (STI)
 EG ISO metric thread DIN 8140-2
 Gauge dimensions acc. DIN ISO 1502
 EG UNC thread acc. factory standard
 EG UNF thread acc. factory standard



LD



ORDER-CODE →		LD		ORDER-CODE →		LD		LD-3B	
d	P mm	6H mod Grenzlehrdorn Plug gauge		d	P Gg/1" tpi	2B Grenzlehrdorn Plug gauge		3B Grenzlehrdorn Plug gauge	
↓				↓					
		Art.-Nr.	€			Art.-Nr.	€	Art.-Nr.	€
EG M 2	0,4	512675	99,80	EG UNC Nr. 2	56	512689	131,00		
EG M 2,5	0,45	512676	93,00	EG UNC Nr. 4	40	512692	118,00	512693	185,00
EG M 3	0,5	512679	83,00	EG UNC Nr. 5	40	512694	117,00		
EG M 4	0,7	512682	74,40	EG UNC Nr. 6	32	512695	107,00	512696	166,00
EG M 5	0,8	512683	71,90	EG UNC Nr. 8	32	512697	100,00	512698	157,00
EG M 6	1	512685	71,90	EG UNC Nr. 10	24	512687	98,20		
EG M 7	1	513473	110,00	EG UNC Nr. 12	24	512688	110,00		
EG M 8	1,25	512686	71,90	EG UNC 1/4"	20	512700	98,00		
EG M 10	1,5	512666	78,10	EG UNC 5/16"	18	512703	107,00		
EG M 12	1,75	512668	104,00	EG UNC 3/8"	16	512702	116,00		
EG M 14	2	512671	126,00	EG UNC 1/2"	13	512699	191,00		
EG M 16	2	512673	139,00	EG UNC 5/8"	11	512704	201,00		
EG M 18	2,5	512674	194,00						
EG M 20	2,5	512677	201,00	EG UNF Nr. 4	48	513095	129,00		
EG M 24	3	513023	237,00	EG UNF Nr. 6	40	512707	112,00		
	↓			EG UNF Nr. 8	36	512709	105,00		
EG M 8	1	513019	143,00	EG UNF Nr. 10	32	512705	98,00	512706	153,00
EG M 10	1	513020	161,00	EG UNF 1/4"	28	512712	98,00	512713	153,00
EG M 10	1,25	515046	201,00	EG UNF 5/16"	24	512716	107,00	512717	167,00
EG M 12	1,25	515572	206,00	EG UNF 3/8"	24	512715	116,00		
EG M 12	1,5	512670	169,00	EG UNF 7/16"	20	513343	145,00		
EG M 14	1,5	512672	176,00	EG UNF 1/2"	20	512711	191,00		
EG M 16	1,5	513021	183,00	EG UNF 5/8"	18	512718	199,00		
EG M 18	1,5	513975	188,00						
EG M 20	1,5	512678	198,00						
EG M 22	1,5	513454	208,00						
EG M 24	1,5	513146	212,00						

Die Lehrung eines EG-Gewindes wird vor dem Einschrauben des Gewindeeinsatzes durchgeführt

Preise für weitere Gewinde auf Anfrage

Threads for wire thread inserts are gauged before the insert is screwed in

Prices for further threads on request



Allgemeine Geschäftsbedingungen Johs. Boss GmbH & Co. KG

I. Allgemeines

1. Für die Geschäftsbeziehung zwischen der Johs. Boss GmbH & Co KG (nachfolgend „Lieferer“), Johannes-Boss-Straße 9, 72461 Albstadt und dem Kunden (nachfolgend „Besteller“) gelten ausschließlich die nachfolgenden Allgemeinen Geschäftsbedingungen (AGB) in ihrer zum Zeitpunkt des Angebots gültigen Fassung. Abweichende Bedingungen des Bestellers werden nicht anerkannt, es sei denn, der Lieferer stimmt ihrer Geltung ausdrücklich schriftlich zu. Die AGB gelten auch dann, wenn der Lieferer in Kenntnis entgegenstehender oder von den Lieferer Bedingungen abweichender Bedingungen des Bestellers die Leistung vorbehaltlos annimmt.

Diese AGB gelten nur gegenüber Bestellern, welche Unternehmer oder juristische Personen des privaten oder öffentlichen Rechtes sind.

Weitere Informationen zu den Kommunikationsdaten und der gesetzlichen Vertretung des Lieferers finden Sie in der Anbieterkennzeichnung (Impressum).

2. Der Lieferer behält sich an Mustern, Kostenvorschlägen, Zeichnungen u.ä. Informationen körperlicher und unkörperlicher Art – auch in elektronischer Form – Eigentums- und Urheberrechte vor; sie dürfen Dritten nicht zugänglich gemacht werden. Der Lieferer seinerseits verpflichtet sich, vom Besteller als vertraulich bezeichnete Informationen und Unterlagen nur mit dessen Zustimmung betriebsfremden Dritten zugänglich zu machen.

3. Die zu einem Angebot des Lieferers gehörenden Unterlagen, wie Abbildungen, Zeichnungen, Gewichts- und Maßangaben, sind nur annähernd maßgebend, soweit sie nicht ausdrücklich als verbindlich bezeichnet sind. Der Besteller übernimmt für die von ihm beizubringenden Unterlagen, wie Zeichnungen, Lehren, Muster oder dgl., die alleinige Verantwortung. Der Besteller hat dafür einzustehen, dass von ihm vorgelegte Ausführungszeichnungen nicht in Schutzrechte Dritter eingreifen. Er wird bei Verstoß den Lieferer von allen hieraus resultierenden Schadenspositionen freistellen.

4. Muster werden nur gegen Berechnung geliefert.

5. Angebotsgültigkeit 8 Wochen. Zwischenverkauf vorbehalten.

II. Umfang der Lieferung

1. Für den Umfang der Lieferung ist die schriftliche Auftragsbestätigung des Lieferers maßgebend, im Falle eines Angebotes des Lieferers mit zeitlicher Bindung und fristgemäßer Annahme das Angebot, sofern keine rechtzeitige Auftragsbestätigung vorliegt. Jede Änderung oder Ergänzung der Auftragsbestätigung, die nicht durch eine individuelle, unmittelbar zwischen den Parteien ausgehandelte Vereinbarung geschieht, bedarf zu ihrer Wirksamkeit der Schriftform.

2. Werden Sonderwerkzeuge in Auftrag

gegeben, so darf die Bestellmenge um ca. 10 %, mindestens jedoch um 2 Stück, über- oder unterschritten werden. Berechnet wird die Liefermenge.

III. Preis und Zahlung

1. Die Preise gelten mangels besonderer Vereinbarung ab Werk einschließlich Verladung im Werk, jedoch ausschließlich Verpackung und Entladung. Zu den Preisen kommt die Umsatzsteuer in der jeweiligen gesetzlichen Höhe hinzu.

2. Mangels besonderer Vereinbarung ist die Zahlung frei Zahlstelle des Lieferers ohne jeden Abzug innerhalb von 30 Tagen nach Rechnungsdatum (auch bei Teillieferungen) oder innerhalb 10 Kalendertagen mit 2% Skonto zu leisten.

3. Das Recht, Zahlungen zurückzuhalten, steht dem Besteller nur insoweit zu, als seine Gegenansprüche unbestritten oder rechtskräftig festgestellt sind.

4. Das Recht des Bestellers, mit Gegenansprüchen aus anderen Rechtsverhältnissen aufzurechnen, steht ihm nur insoweit zu, als diese unbestritten oder rechtskräftig festgestellt sind.

IV. Lieferzeit, Lieferverzögerung

1. Eine vereinbarte Lieferfrist beginnt mit der Absendung der Auftragsbestätigung, jedoch nicht vor der Beibringung der vom Besteller zu beschaffenden Unterlagen, Genehmigungen, Freigaben sowie vor Eingang einer vereinbarten Anzahlung auf der vereinbarten Zahlstelle des Lieferers.

2. Die Einhaltung der Lieferfrist steht unter dem Vorbehalt richtiger und rechtzeitiger Selbstbelieferung.

3. Die Lieferfrist ist eingehalten, wenn bis zu ihrem Ablauf der Liefergegenstand das Werk verlassen hat oder die Versandbereitschaft mitgeteilt ist. Soweit eine Abnahme zu erfolgen hat, ist – außer bei berechtigter Abnahmeverweigerung – der Abnahmetermin maßgebend, hilfsweise die Meldung der Abnahmebereitschaft.

4. a) „Höhere Gewalt“ bedeutet das Eintreten eines Ereignisses oder Umstands, das eine Partei daran hindert, eine oder mehrere ihrer vertraglichen Verpflichtungen aus dem Vertrag zu erfüllen, wenn und soweit die von dem Hindernis betroffene Partei nachweist, dass: (a) dieses Hindernis außerhalb der ihr zumutbaren Kontrolle liegt; und (b) es zum Zeitpunkt des Vertragsabschlusses nicht in zumutbarer Weise vorhersehbar war; und (c) die Auswirkungen des Hindernisses von der betroffenen Partei nicht in zumutbarer Weise hätten vermieden oder überwunden werden können.

b) Bis zum Beweis des Gegenteils wird bei den folgenden Ereignissen vermutet, die eine Partei betreffen, sie würden die Voraussetzungen unter Absatz 1 lit. (a) und lit. (b) nach Absatz 1 dieser Klausel erfüllen: (i) Krieg (erklärt oder nicht erklärt), Feindseligkeiten, Angriff, Handlungen ausländischer Feinde, umfangreiche militärische Mo-

bilisierung; (ii) Bürgerkrieg, Aufruhr, Rebellion und Revolution, militärische oder sonstige Machtergreifung, Aufstand, Terrorakte, Sabotage oder Piraterie; (iii) Währungs- und Handelsbeschränkungen, Embargo, Sanktionen; (iv) rechtmäßige oder unrechtmäßige Amtshandlungen, Befolgung von Gesetzen oder Regierungsanordnungen, Enteignung, Beschlagnahme von Werken, Requisition, Verstaatlichung; (v) Pest, Epidemie, Naturkatastrophe oder extremes Naturereignis; (vi) Explosion, Feuer, Zerstörung von Ausrüstung, längerer Ausfall von Transportmitteln, Telekommunikation, Informationssystemen oder Energie; (vii) allgemeine Arbeitsunruhen wie Boykott, Streik und Aussperrung, Bummelstreik, Besetzung von Fabriken und Gebäuden.

c) Eine Partei, die sich mit Erfolg auf diese Klausel beruft, ist ab dem Zeitpunkt, zu dem das Hindernis ihr die Leistungserbringung unmöglich macht, von ihrer Pflicht zur Erfüllung ihrer vertraglichen Verpflichtungen und von jeder Schadenersatzpflicht oder von jedem anderen vertraglichen Rechtsbehelf wegen Vertragsverletzung befreit; sofern dies unverzüglich mitgeteilt wird. Erfolgt die Mitteilung nicht unverzüglich, so wird die Befreiung von dem Zeitpunkt an wirksam, zu dem die Mitteilung die andere Partei erreicht. Ist die Auswirkung des geltend gemachten Hindernisses oder Ereignisses vorübergehend, so gelten die eben dargelegten Folgen nur so lange, wie das geltend gemachte Hindernis die Vertragserfüllung durch die betroffene Partei verhindert. Hat die Dauer des geltend gemachten Hindernisses zur Folge, dass den Vertragsparteien dasjenige, was sie kraft des Vertrages berechtigterweise erwarten durften, in erheblichem Maße entzogen wird, so hat jede Partei das Recht, den Vertrag durch Benachrichtigung der anderen Partei innerhalb eines angemessenen Zeitraums zu kündigen. Sofern nicht anders vereinbart, vereinbaren die Parteien ausdrücklich, dass der Vertrag von jeder Partei gekündigt werden kann, wenn die Dauer des Hindernisses 120 Tage überschreitet.

5. Wird der Versand auf Wunsch des Bestellers verzögert, so ist der Lieferer berechtigt, nach Setzung und fruchtlosem Ablauf einer angemessenen Frist, anderweitig über den Liefergegenstand zu verfügen und den Besteller mit angemessen verlängerter Frist zu beliefern. Oder es werden beginnend mit einem Monat nach Meldung der Versand- bzw. der Abnahmebereitschaft, die durch die Verzögerung entstandenen Kosten berechnet.

6. Die Einhaltung der Lieferfrist setzt die Erfüllung der Vertragspflichten des Bestellers voraus.

V. Gefahrübergang und Entgegennahme

1. Die Gefahr geht mit der Absendung der Lieferteile auf den Besteller über, und zwar auch dann, wenn Teillieferungen erfolgen oder der Lieferer noch andere Leistungen, z.B. die Versandkosten oder Anfuhr und/oder

Aufstellung übernommen hat.

Auf Wunsch des Bestellers wird auf Kosten des Bestellers die Sendung der Lieferteile durch den Lieferer gegen Diebstahl, Bruch-, Transport-, Feuer- und Wasserschäden sowie sonstige, versicherbare, vom Besteller geforderte Risiken versichert.

2. Verzögert sich der Versand infolge von Umständen, die der Besteller zu vertreten hat, so geht die Gefahr vom Tage der Versandbereitschaft auf den Besteller über; jedoch ist der Lieferer verpflichtet, auf Wunsch und auf Kosten des Bestellers die Versicherungen für die Lieferteile zu bewirken, die dieser verlangt.

3. Angelieferte Gegenstände sind, auch wenn sie unwesentliche Mängel aufweisen, vom Besteller unbeschadet der Rechte aus Abschnitt VII entgegenzunehmen.

4. Teillieferungen sind, soweit diese dem Besteller zumutbar sind, zulässig.

VI. Eigentumsvorbehalt

1. Der Lieferer behält sich das Eigentum an der Ware vor, bis sämtliche Forderungen des Lieferers gegen den Besteller aus der Geschäftsverbindung zum Zeitpunkt des Abschlusses des konkreten Kaufvertrages, einschließlich der künftig entstehenden Forderungen auch aus gleichzeitig oder später abgeschlossenen Verträgen beglichen sind. Das gilt auch dann, wenn einzelne oder sämtliche Forderungen des Lieferers in eine laufende Rechnung aufgenommen wurden und der Saldo gezogen und anerkannt ist.

2. Der Besteller ist zur Weiterveräußerung der Vorbehaltsware im ordnungsgemäßen Geschäftsgang nur dann berechtigt, wenn er dem Lieferer hiermit alle Forderungen abtritt, die ihm aus der Weiterveräußerung gegen Abnehmer oder gegen Dritte erwachsen. Wird Vorbehaltsware unverarbeitet oder nach Verarbeitung oder Verbindung mit Gegenständen, die ausschließlich im Eigentum des Bestellers stehen, veräußert, so tritt der Besteller die aus der Weiterveräußerung entstehenden Forderungen in voller Höhe an den Lieferer ab. Wird Vorbehaltsware vom Besteller nach Verarbeitung/Verbindung zusammen mit nicht dem Lieferer gehörender Ware veräußert, so tritt der Besteller die aus der Weiterveräußerung entstehenden Forderungen in Höhe des Wertes der Vorbehaltsware mit allen Nebenrechten und Rang vor dem Rest ab. Der Lieferer nimmt die Abtretung an. Zur Einziehung dieser Forderungen ist der Besteller auch nach Abtretung ermächtigt. Die Befugnis des Lieferers, die Forderung selbst einzuziehen, bleibt hiervon unberührt; jedoch verpflichtet sich der Lieferer, die Forderungen nicht einzuziehen, solange der Besteller seinen Zahlungs- und sonstigen Verpflichtungen ordnungsgemäß nachkommt. Der Lieferer kann verlangen, dass der Besteller ihm die abgetretenen Forderungen und deren Schuldner bekannt gibt, alle zum Einzug erforderlichen Angaben macht, die dazu gehörigen Unterlagen

aushändig und dem Schuldner die Abtretung mitteilt.

3. Der Lieferer verpflichtet sich, die ihm zustehenden Sicherungen insoweit freizugeben, als ihr Wert die zu sichernden Forderungen, soweit diese noch nicht beglichen sind, um mehr als 20% übersteigt.

4. Der Lieferer ist berechtigt, vor erfolgter Bezahlung, den Liefergegenstand auf Kosten des Bestellers gegen Diebstahl, Bruch-, Feuer-, Wasser- und sonstige Schäden zu seinen Gunsten zu versichern, sofern nicht der Besteller selbst die Versicherung nachweislich abgeschlossen hat.

5. Der Besteller hat bei Pfändungen sowie Beschlagnahme oder sonstigen Verfügungen durch Dritte in den Liefergegenstand den Lieferer unverzüglich umfassend schriftlich zu benachrichtigen.

VII. Haftung für Mängel der Lieferung

Für Mängel der Lieferung, zu denen auch das Fehlen von ausdrücklich zugesicherten Eigenschaften gehört, haftet der Lieferer unter Ausschluss weiterer Ansprüche unbeschadet Abschnitt IX, 4, wie folgt dargestellt. Hierbei ist vorab darauf hinzuweisen, dass der typische Verschleiß von Werkzeugen keine Gewährleistungsfrage ist. Sollte damit kein Mangel beim Lieferteil vorliegen, auch innerhalb der Gewährleistungszeit üblicher Verschleiß zu Unbrauchbarkeit führen kann.

1. Alle diejenigen Lieferteile sind unentgeltlich nach billigem Ermessen des Lieferers unterliegender Wahl nachzubessern oder neu zu liefern, die sich innerhalb von 12 Monaten seit Gefahrübergang der Lieferteile infolge eines vor dem Gefahrübergang liegenden Umstandes – insbesondere wegen fehlerhafter Bauart, schlechter Baustoffe oder mangelhafter Ausführung – als mangelbehaftet herausstellen.

Die Feststellung solcher Mängel ist dem Lieferer unverzüglich unter Beschreibung des Mangels schriftlich zu melden. Ersetzte Teile werden Eigentum des Lieferers. Für Mängel des vom Besteller beigegebenen und angelieferten Materials haftet der Lieferer nur, wenn er bei Anwendung fachmännischer Sorgfalt die Mängel vor Verarbeitung hätte erkennen müssen.

Bei Lohnfertigung nach Zeichnung des Bestellers haftet der Lieferer nur für die zeichnungsmäßige Ausführung.

2. Das Recht des Bestellers, Ansprüche aus Mängeln geltend zu machen verjährt in 12 Monaten nach Gefahrübergang.

3. Es wird keine Gewähr übernommen für Schäden, die aus nachfolgenden Gründen entstanden sind:

Ungeeignete oder unsachgemäße Verwendung, fehlerhafte Montage bzw. Inbetriebsetzung durch den Besteller oder Dritte, natürliche Abnutzung, fehlerhafte oder nachlässige Behandlung, ungeeignete Betriebsmittel, chemische, elektrochemische oder elektrische

Einflüsse, sofern sie nicht auf ein Verschulden des Lieferers zurückzuführen sind.

4. Zur Vornahme aller notwendigen Nachbesserungen und Ersatzlieferungen hat der Besteller nach Verständigung mit dem Lieferer die erforderliche Zeit und Gelegenheit zu geben. Nur in dringenden Fällen der Gefährdung der Betriebssicherheit und zur Abwehr unverhältnismäßig großer Schäden, wobei der Lieferer sofort zu verständigen ist, oder wenn der Lieferer mit der Beseitigung des Mangels im Verzug ist, hat der Besteller das Recht, den Mangel selbst oder durch Dritte beseitigen zu lassen und vom Lieferer Ersatz der notwendigen Kosten zu verlangen.

5. Für ein Ersatzstück und/oder die Nachbesserung (im Falle von Kulanzabwicklung ohne festgestellten Gewährleistungsfall) begrenzt sich die Gewährleistungsfrist auf den Ablauf der ursprünglichen Gewährleistungsfrist für den Liefergegenstand.

6. Durch etwa seitens des Bestellers oder Dritter unsachgemäß, ohne vorherige Genehmigung des Lieferers, vorgenommene Änderung oder Instandsetzungsarbeiten wird die Gewährleistung und/oder Garantie für das Lieferteil sowie eventuelle Folgeschäden aufgehoben.

7. Die Haftung für Kardinalpflichten aus dem Vertragsverhältnis wird auf den vertragstypischen, vorhersehbaren Schaden begrenzt. Für nichtvertragswesentliche Pflichtverletzungen wird die Haftung für einfache und leichte Fahrlässigkeit ausgeschlossen.

Dieser Haftungsausschluss gilt nicht bei Vorsatz oder grober Fahrlässigkeit des Inhabers oder leitenden Angestellten und in den Fällen, in denen nach Produkthaftungsgesetz bei Fehlern des Liefergegenstandes für Personen- oder Sachschäden an privat genutzten Gegenständen gehaftet wird. Er gilt auch nicht beim Fehlen von Eigenschaften, die ausdrücklich zugesichert sind, wenn die Zusicherung gerade bezweckt hat, den Besteller gegen Schäden, die nicht am Liefergegenstand selbst entstanden sind, abzusichern.

VIII. Haftung für Nebenpflichten/Haftungsbegrenzung

Wenn durch Verschulden des Lieferers der gelieferte Gegenstand vom Besteller infolge unterlassener oder fehlerhafter Ausführung von vor oder nach Vertragsschluss liegenden Vorschlägen und Beratungen sowie anderen Nebenpflichtungen – insbesondere Anleitung für Bedienung und Wartung des Liefergegenstandes – nicht vertragsgemäß verwendet werden kann, so gelten unter Ausschluss weiterer Ansprüche des Bestellers die Regelungen der Abschnitte VII und IX entsprechend. Die Haftung wird auf 10 % bei leichter Fahrlässigkeit begrenzt.

IX. Recht des Bestellers auf Rücktritt

1. Liegt Leistungsverzug im Sinne des Abschnittes IV der Lieferbedingungen

vor und gewährt der Besteller dem in Verzug befindlichen Lieferer eine angemessene Nachfrist mit der ausdrücklichen Erklärung, dass er nach Ablauf dieser Frist die Annahme der Leistung ablehne, und wird die Nachfrist nicht eingehalten, so ist der Besteller zum Rücktritt berechtigt.

2. Tritt die Unmöglichkeit während des Annahmeverzuges oder durch Verschulden des Bestellers ein, so bleibt dieser zur Gegenleistung verpflichtet.

3. Der Besteller hat ferner ein Rücktrittsrecht, wenn der Lieferer eine ihm gestellte angemessene Nachfrist für die Nachbesserung oder Ersatzlieferung bezüglich eines von ihm zu vertretenden Mangels im Sinne der Lieferbedingungen durch sein Verschulden fruchtlos verstreichen lässt. Das Rücktrittsrecht des Bestellers besteht auch in sonstigen Fällen des Fehlschlagens der Ausbesserung oder Ersatzlieferung durch den Lieferer.

X. Besondere Bedingungen für Bearbeitungsverträge (Fertigstellung, Aufarbeitung, Umarbeitung oder Wiederherstellung von Werkzeugen)

Ergänzend zu oder abweichend von den Lieferbedingungen gilt für derartige Bearbeitungsverträge:

1. Die Rechnungen sind sofort ohne Abzug zu bezahlen.

2. Für die Qualität und Brauchbarkeit des an den Lieferer eingesandten und damit vom Besteller beigegebenen Materials übernimmt der Lieferer keine Haftung. Sein Anspruch auf Vergütung bleibt unberührt. Wird das Material bei der Bearbeitung durch Verschulden des Lieferers unbrauchbar, entfallen der Vergütungsanspruch des Lieferers. Für einen Schaden gelten die Bestimmungen der Ziffern VII und VIII.

XI. Verjährung

Alle Ansprüche des Bestellers – aus welchen Rechtsansprüchen auch immer – verjähren in 12 Monaten ab Gefahrübergang.

XII. Softwarenutzung

Soweit im Lieferumfang Software enthalten ist:

(1) Der Besteller erwirbt das einfache, zeitlich und räumlich unbeschränkte Recht, die enthaltene Software bestimmungsgemäß zu internen Zwecken zu verwenden. Hierzu darf er die Software installieren und auf einem Liefergegenstand gleichzeitig nutzen. Die Rechteinräumung bezieht sich nicht auf den Quellcode der Software. Rechte zur Bearbeitung, Verbreitung oder öffentlichen Zugänglichmachung der Software werden nicht gewährt.

(2) Sicherungskopien darf der Besteller nur erstellen, soweit es für den vertragsgemäßen Gebrauch des Liefergegenstandes erforderlich ist. Bewegliche Datenträger, die Sicherungskopien enthalten, sind mit dem Urheberrechtsvermerk des Originaldatenträgers zu versehen.

(3) Dem Besteller ist es nicht gestattet, die gem. Absatz 1 eingeräumten Nutzungsrechte an Dritte abzutreten, zu übertragen oder Unterlizenzen an ihnen einzuräumen.

(4) Der Besteller verpflichtet sich, Herstellerangaben – insbesondere Copyright-Vermerke – nicht zu entfernen oder ohne vorherige ausdrückliche Zustimmung des Lieferers zu verändern.

(5) Resultieren Schäden des Bestellers aus dem Verlust von Daten, so haftet der Lieferer hierfür nicht, soweit die Schäden durch eine regelmäßige und vollständige Sicherung aller relevanten Daten durch den Besteller vermieden worden wären. Der Besteller wird eine regelmäßige und vollständige Datensicherung selbst oder durch einen Dritten durchführen bzw. durchführen lassen und ist hierfür allein verantwortlich.

(6) Der Besteller ist im Hinblick auf personenbezogene Daten von sich und seinen Nutzern Verantwortlicher nach Art. 4 Nr. 7 DS-GVO und hat daher stets zu prüfen, ob die Verarbeitung solcher Daten über die Nutzung der Software von entsprechenden Erlaubnistatbeständen getragen ist.

(7) Der Besteller ist für sämtliche von ihm oder seinen Nutzern verwendeten Inhalte und verarbeiteten Daten sowie die hierfür etwa erforderlichen Rechtspositionen allein verantwortlich. Der Lieferer nimmt von Inhalten des Bestellers oder seiner Nutzer keine Kenntnis und prüft die mit der Software genutzten Inhalte grundsätzlich nicht.

(8) Der Besteller verpflichtet sich in diesem Zusammenhang, den Lieferer von jeder Haftung und jeglichen Kosten, einschließlich möglicher und tatsächlicher Kosten eines gerichtlichen Verfahrens, freizustellen, falls der Lieferer von Dritten, auch von Mitarbeitern des Bestellers persönlich, infolge von behaupteten Handlungen oder Unterlassungen des Bestellers in Anspruch genommen wird. Der Lieferer wird den Besteller über die Inanspruchnahme unterrichten und ihm, soweit dies rechtlich möglich ist, Gelegenheit zur Abwehr des geltend gemachten Anspruchs geben. Gleichzeitig wird der Besteller dem Lieferer unverzüglich alle ihm verfügbaren Informationen über den Sachverhalt, der Gegenstand der Inanspruchnahme ist, vollständig mitteilen.

XIII. Gerichtsstand

1. Für alle Rechtsbeziehungen zwischen dem Lieferer und dem Besteller gilt ausschließlich das für die Rechtsbeziehungen inländischer Parteien untereinander maßgebliche Recht der Bundesrepublik Deutschland unter Ausschluss der Regeln des UN-Kaufrechtes.

2. Gerichtsstand ist das für den Sitz des Lieferers zuständige Gericht. Der Lieferer ist jedoch berechtigt, am Hauptsitz des Bestellers Klage zu erheben.

M
MF
MJ
EG M

G
Rc, R
Pg

UNC
UNF
UN
UNJF

NPT
NPTF

M
MF
M keg.
M taper

G
BSW
BSF
DIN 477
R, BA, Pg

UNC
UNF
UNEF
UN, UNS

NPSM
NPT
NPTF
Tr, Rd

M
MF

G
BSW
BSF
R, Pg
MF-EL

UNC, UNF
UNEF
UN, UNS
UNJC
UNJF

NPT
NPTF
Tr
EG

- M
MF
MJ
EG M
- G
Rc, R
Pg
- UNC
UNF
UN
UNJF
- NPT
NPTF
- M
MF
M keg.
M taper
- G
BSW
BSF
DIN 477
R, BA, Pg
- UNC
UNF
UN, UNS
- NPSM
NPT
NPTF
Tr, Rd
- M
MF
- G
BSW
BSF
R, Pg
MF-EL
- UNC, UNF
UNEF
UN, UNS
UNJC
UNJF
- NPT
NPTF
Tr
EG



Johs. Boss GmbH & CO. KG
Präzisionswerkzeugfabrik
Precision Tool Manufacturer

toolingpartners.com

Johannes-Boss-Straße 9
 72461 Albstadt
 Germany

Tel. +49 7432 9087 0
 Fax +49 7432 9087 60

contact@johs-boss.de
www.johs-boss.de

© 2022